

# Quick Start Guide

## Premier Elite *Ricochet*® Enabled Kits

INS626



# Contents

<b>Contents</b> .....	<b>2</b>
<b>Introduction</b> .....	<b>3</b>
Additional Items Required .....	3
System Architecture .....	3
<b>System Design &amp; Installation Considerations</b> .....	<b>4</b>
Wiring the Control Panel .....	4
Connecting AC Mains .....	4
<b>Design the Layout</b> .....	<b>5</b>
Control Panel .....	5
System Keypads .....	5
Movement Sensors .....	5
Door Contacts .....	5
Shock Sensors.....	5
External Sounder .....	5
Smoke Detector .....	5
<b>Device Locations</b> .....	<b>5</b>
<b>Installation Sequence</b> .....	<b>6</b>
Control Panel .....	6
<b>Keypad Types</b> .....	<b>6</b>
Keypad.....	6
Keys Guide.....	6
LED Symbols .....	6
<b>Connecting Keypads &amp; Expanders</b> .....	<b>7</b>
Premier Elite 12/24 & 48-W Live Front.....	7
Wiring the Network.....	7
Keypad & Expander Addressing .....	8
<b>Installing Ricochet devices</b> .....	<b>8</b>
Learning Devices.....	8
Device Type .....	8
Learn method.....	8
Auto Zone Type & Area.....	9
Deleting Devices .....	9
Placing Devices.....	9
Learning SmartKeys.....	10
Deleting a Premier Elite SmartKey™ .....	10
<b>Finishing the Installation</b> .....	<b>11</b>
Testing the System .....	11
<b>Further Programming Options</b> .....	<b>11</b>
Quick Programming Guide .....	11
<b>Changing the default codes</b> .....	<b>20</b>
Changing the Default Codes.....	20
User.....	20
Engineer.....	20
<b>Changing the Time &amp; Date</b> .....	<b>21</b>
Time .....	21
Date.....	21
<b>Control Panel Features</b> .....	<b>21</b>
Premier Elite 12-W/24-W/48-W.....	21
<b>Control Panel Layout (Premier Elite™ 48-W Shown)</b> .....	<b>22</b>
<b>PCB Layout (48-W Shown)</b> .....	<b>22</b>

## Introduction

Texecom has developed a new method of wireless security signalling based on the concept of mesh networking. Mesh-networking is the process whereby every single wireless device is capable of receiving and retransmitting any signal from any other wireless device on the network. The size, scalability and range of the entire system are extended as wireless signalling is no longer limited by point-to-point communications. The range of a **Ricochet**® enabled wireless system is greater than previous systems, with multiple devices capable of relaying messages to and from even the most remote locations in a building. Each *Ricochet* enabled device provides signalling routes to and from Premier control panels. If the wireless communication between devices weakens, the *Ricochet* network 'self-heals' and automatically re-routes communications via alternate *Ricochet* enabled devices. The reliability of the wireless system increases as more *Ricochet* devices are installed. **SignalSecurity**™ further enhances network reliability with each device already aware of the number of communication paths available to it.

This quick start guide will enable you to install and programme the system. Detailed instruction manuals for all of the components of the kits can be found on the enclosed CD. Any additional items purchased will also contain detailed instructions.

## Additional Items Required

In addition to the contents of the kit you will need the following to complete the installation:-

- 7Ah Lead Acid back up battery
- Alarm cable (if installing remote keypads or wired detection devices & sounders)
- Mains Cable
- 3A unswitched fused spur
- Screws & Rawl plugs (No6, No8 & No10)
- Hammer drill, various screwdrivers
- Mini Trunking.
- PC or Laptop running Windows Vista, 7 or 8 (If programming from a PC)
- JAC-0001 Texecom USB Com Lead (If programming from a PC)
- A cover for the External Sounder

## System Architecture

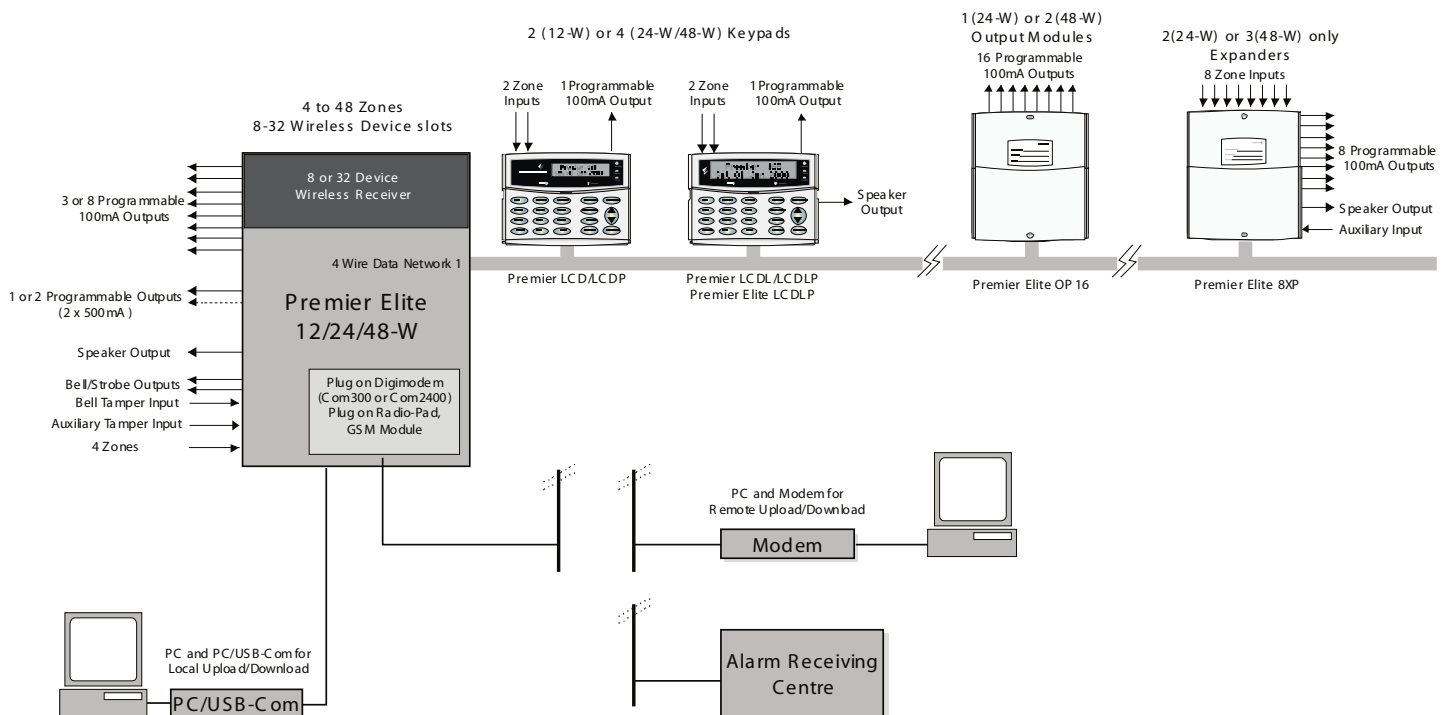

## System Design & Installation Considerations

Before attempting to install the alarm system, read this section. Once you have an overall understanding of the installation sequence, carefully work through each step.

**This quick reference guide will allow you to install your alarm system and programme all of the required basic functions. Further in-depth programming options for the system are available in the manuals provided on the enclosed CD or on our website.**

### 1: Design the Layout

Make a rough sketch of the premises to get an idea of where all alarm detection devices, keypads and other modules are to be located.

### 2: Arming/Disarming

It is highly recommended that SmartKey are used to arm and disarm the system. This will allow for the control panel and any associated keypads to be placed in a secure area in the property.

### 3: Control Panel Location

The control panel should be mounted in a dry area close to an unswitched AC power source.



*You must complete all wiring before connecting the battery, or applying AC Mains to the panel.*

## Wiring the Control Panel

### WARNING: ELECTRICITY CAN KILL

**BEFORE connecting the control panel ALWAYS disconnect the supply at the consumer unit.  
If in ANY doubt consult a qualified electrician.**



IMPORTANT SAFETY INFORMATION. HAZARDOUS VOLTAGES INSIDE, NO USER SERVICEABLE PARTS, NO USER ACCESS.



*ONLY connect the mains supply to the mains terminal block, NEVER connect the mains supply directly to the PCB.*

- ALWAYS refer to National Wiring Regulations when conducting installation.
- An appropriate and readily accessible disconnection device (e.g. an unswitched fused spur) MUST be provided as part of the installation.
- The disconnection device must NOT be fitted in a flexible cord.
- Where identification of the neutral in the mains supply is NOT possible a two-pole disconnection device MUST be used.
- The building mains supply MUST incorporate appropriate short-circuit backup protection (e.g. a fuse or circuit breaker) of High Breaking Capacity (HBC, at least 1500A).
- Use mains cable of adequate carrying capacity for the rated current (i.e. at least 0.75mm<sup>2</sup>)

## Connecting AC Mains

The AC Mains supply is connected to a 3 way 'Euro Type' fused terminal block, which is fitted with a 3A - 3.15A slow/medium blow fuse.



*All other wiring MUST be carried out before AC mains is connected to the control panel.*

After connecting the AC Mains, fit the mains cover, this can be found in the spares bag.

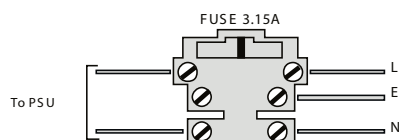

## 4: Install the Keypads

Where separate keypads are supplied, if using them to Arm/Disarm the system, these should be located on the entry route. Mount and connect the keypads to the control panel.

## 5: Zone Wiring

If any of the hardwired zones are to be used, Install detection devices and connect to the control panel.

## 6: Other Wiring

Complete all other wiring including bells or sirens and telephone line connections.

**7: Apply Power to the Control Panel**

Once steps 1 to 5 are completed, apply power to the control panel.

**8: Installation Records**

You should record notes detailing the location of each device installed on the system, and the date of installation.

**9: Learning & Placing Ricochet Devices**

Learn devices to the system and place them in their desired location.

**10: Programme the System**

Programme the system according to the requirements

**11: Testing the System**

Test the system thoroughly to ensure that all features and functions are operating as required.

## Design the Layout

Depending on the Kit and any additional items purchased the system should be drawn out so that you have a clear idea of where all of the components will be placed. The following guide should help you plan a trouble free system.

**Control Panel**

- The control panel should be placed in a secure area within the property.
- Located near a suitable mains supply
- Centrally in the building wherever possible
- Easy to access for programming and maintenance

**System Keypads**

- Should be placed on the entry route if used for arming and disarming
- Should be placed with the Control Panel if SmartKeys or the App's are used for arming/disarming

**Movement Sensors**

- Minimum of one per ground floor room.
- Should be placed looking into a room (not looking out of windows)
- Mounted at the correct working height 2Mtr - 2.4Mtr from the floor

**Door Contacts**

- The main body should be placed on the door frame
- The magnet should be placed on the door itself

**Shock Sensors**

- Should be mounted on the frames of doors or windows being protected

**External Sounder**

- Should be placed on a suitable external elevation to attract attention in the case of an activation.
- Should be accessible for future maintenance

**Smoke Detector**

- Should be placed in a central location with a minimum of one device per floor of the property. In the case of larger properties careful consideration should be given to the number of devices required. The coverage, mounting height and audible noise level from each device must be checked.

## Device Locations

For all devices, unless specified that they are suitable for the application, please observe the following guidelines.

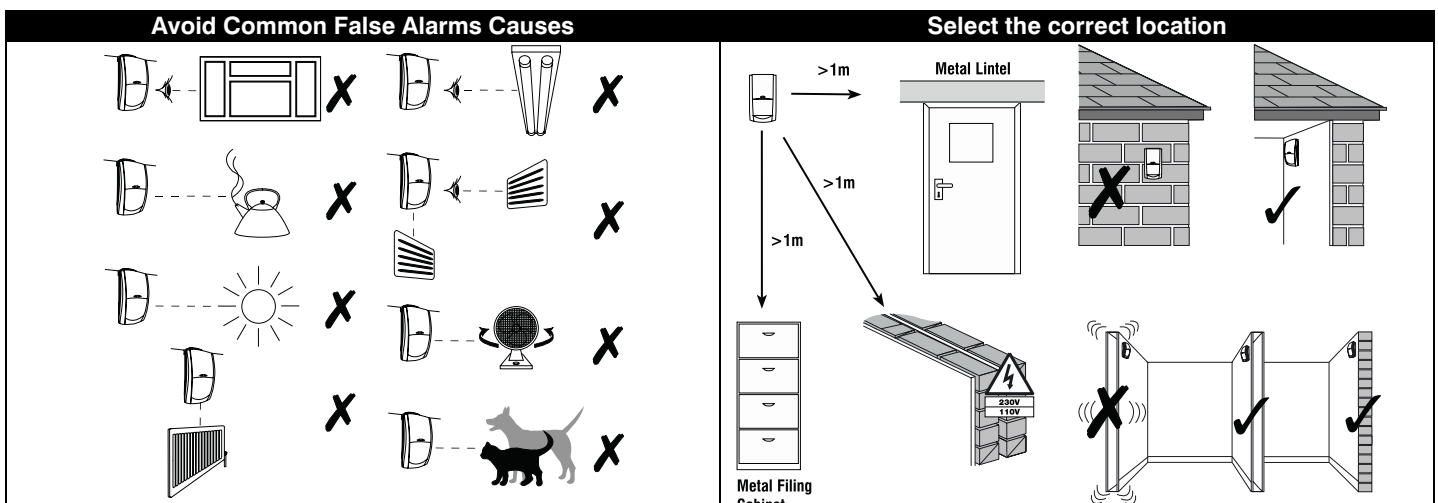

## Installation Sequence

### Control Panel

1. Install the control panel in the chosen location.
2. Power up the Control Panel, using the battery first method, and loading factory defaults. To do this proceed as follows:-
  - a. Connect Red battery lead.
  - b. Connect Black battery lead.
  - c. Hold down the Load defaults button on the PCB.
  - d. Press and release the battery kick start button.
  - e. Release Load Defaults button.
  - f. Any connected keypads or internal speakers may go into alarm
  - g. Enter the default Engineers Code 1234.
  - h. Enter the default Engineers code 1234 again.
  - i. Connect AC Mains
3. The Keypad display will now show "Confirm Devices", press /Yes and /Yes again to confirm that all connected keypads and expanders are accounted for..
4. The Keypad display will now show "Learn Ricochet".
5. Fit the provided jumper link on the control panel PCB to enable commission mode.



NOTE If a standalone Ricochet expander is used commission mode is enabled when the tamper circuit is open.

## Keypad Types

Texecom provide a number of different styles of keypads. The image below shows the layout of the Premier LCDLP Keypad with iconic keys, a large screen and Proximity tag capability. The table details the equivalent keys of an alternate is supplied.

Keypad		Keys Guide				
		ICONS		UK English		English
			=	Omit	=	Bypass
			=	Chime	=	Chime
			=	Part	=	Stay
			=	Area	=	Area
			=	Reset	=	Reset
			=	Menu	=	Menu
			=	Yes	=	Yes
		OK	=	Yes	=	Yes
			=	No	=	No
		<b>LED Symbols</b>				
	=	Power		=	Ready	
	=	Armed/Info	OK	=	Ready	
	=	Omit		=	Service	

## Connecting Keypads & Expanders

Before connecting keypads, zone expanders and output modules, isolate ALL power from the control panel (AC Mains & Battery). Do not continue if there is still power present on the control panel.

### Premier Elite 12/24 & 48-W Live Front

Panels with an integral keypad are already wired and should be connected as shown.

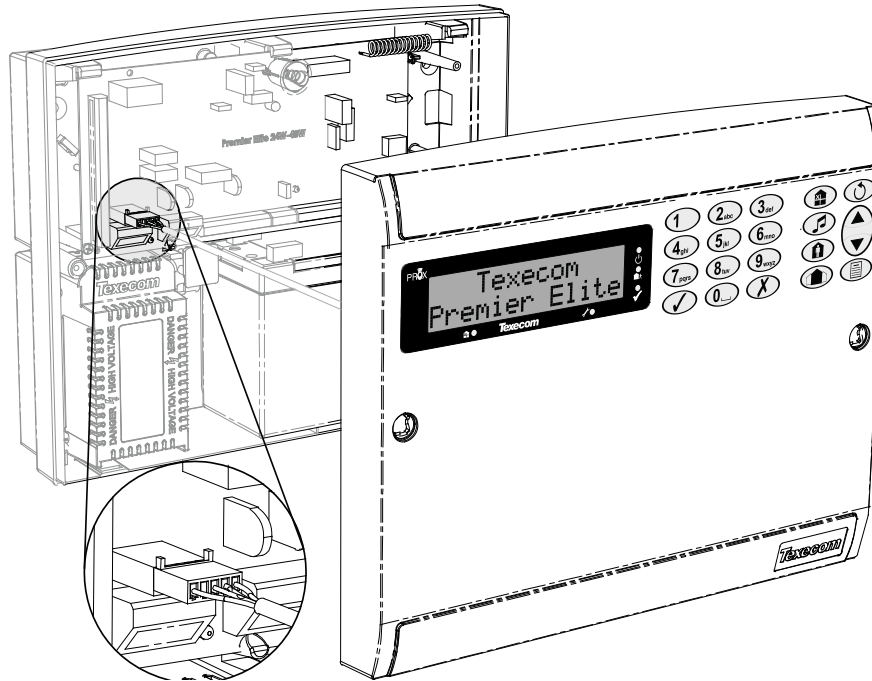

**NOTE** Connecting devices with power still present on the control panel may damage the device or control panel and invalidate any warranty.

Keypads, zone expanders and output modules are all connected to the same network terminals located at the bottom left hand corner of the control panel and may be connected serially (daisy chain), in parallel (star) or any combination of the two (see Figure 1, page **Error! Bookmark not defined.** for details).



**NOTE** No more than 8 zone expanders, 8 keypads and 4 output modules can be connected to each network.

The maximum number of devices that can be connected in total will depend on the control panel fitted.

Whenever new devices are connected to the networks, they must be confirmed onto the system using the 'Confirm Devices' menu option

### Wiring the Network

The networks are made up of four terminals incorporating power and data. To ensure correct operation, all four terminals on the device must be connected to the corresponding terminals on the control panel, or previous device (see Figure 1, page **Error! Bookmark not defined.** for details). The table below shows each terminal and its description:

Terminal	Description
+	+12V Supply
-	0V Supply
T	Transmit Data
R	Receive Data

Devices can be connected using 4-core cable. However, it is recommended that 6 or 8-core cable is used as the spare cores can be used to 'Double Up' on the power connections if needed.



**NOTE** Standard 7/0.2 alarm cable can be used for most installations. However, under certain conditions it may be necessary to use screened cable. Cable used should be rated at no more than 10Ω per 100mtr's and should be clearly marked on the packaging.

### Keypad & Expander Addressing

Each keypad or expander must be assigned an address using the DIL switches located on the left hand side of the PCB. The table below shows the addressing:

Address	DIL 1	DIL 2	DIL 3	DIL 4	
1	On or off	Off	Off	Off	
2	Off	On	Off	Off	
3	Off	Off	On	Off	
4	Off	Off	Off	On	
5 *	On	Off	Off	On	
6 *	Off	On	Off	On	
7 *	Off	Off	On	On	
8 *	On	Off	On	On	
Engineers	On	On	On	On	

**NOTE** Never set two keypads on the same network to the same address. Never set two expanders on the same network to the same address. It is OK to have a keypad and an expander using the same address.

### Installing Ricochet devices

To ensure correct setup and operation of the Wireless Network it is important that the following procedures are used when learning and placing devices.

#### Learning Devices

All devices should be learnt **before** they are placed in their final location. The expander should be in commission mode, as above. This will ensure that they are registered on the receiver or control panel, and that Mesh Networks and routing are established correctly. SmartKey should be learned after all other devices have been assigned to the system and are in their final location.

The following table details the method for powering up and learning each type of device.

Device Type	Learn method
Premier Compact All models	Pull battery tab or Insert battery
Impaq Contact & Plus	Short learn pins and insert battery
Odyssey-W	Insert batteries and move Battery Jumper to ON position
OH-W & PA-W	Pull battery tab or Insert battery
Premier Elite QD/XT & DT	Hold down learn switch & insert battery.
SmartKey	Power on

**NOTE** Devices should be at least 30cm's away from the receiver when being learned.

Referring now to your system design plan, learn all devices to the control panel. To learn devices to the system follow the diagram below. Ricochet devices will start at Zone 9.

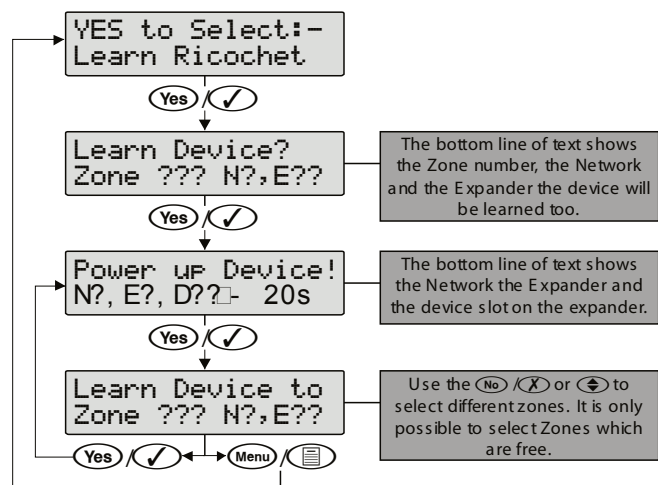





## Auto Zone Type & Area

When learning devices, if no editing has taken place of the control panel onboard hardwired zones, these will be switched to Not Used after the first *Ricochet* device is learned to the system; the following defaults will be used for *Ricochet* devices learned to the system.

Zone	Type	Area
001-008 (Hardwired)	Not Used	N/A
009 (Wireless)	Entry/Exit 1	A
010 (Wireless)	Guard Access	A
011 & above (Wireless)	Guard	A

When all device slots have been used the following screen will be shown

```
All Devices
Learnt!
```

Pressing the /Menu key will return you to the *Ricochet* learn menu; pressing the /Reset key will enter the Delete devices menu.

## Deleting Devices

### Delete Devices

If you make a mistake you can remove devices from the system and start again. To delete devices from the system, access the *Ricochet* Learn menu. Any of the methods previously detailed may be used.

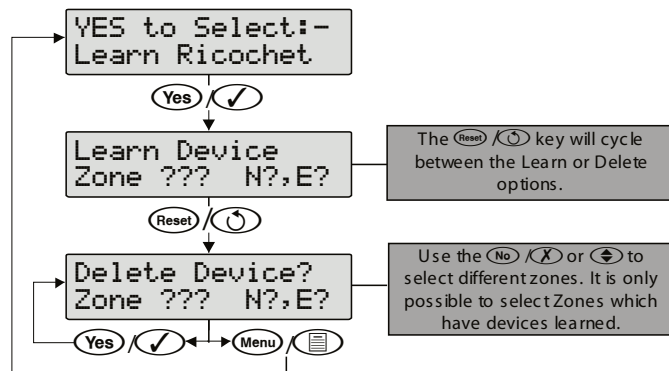

The /Reset key is used to access the Delete option.

Follow the flow diagram below to delete devices from the system.



If all devices are deleted from the system the following will be shown

```
All Devices
Deleted!
```

Pressing the /Menu key will return you to the *Ricochet* learn menu; pressing the /Reset key will enter the Learn devices menu.

Once you have finished Learning devices press the /Menu key, the display will show

```
YES to Select:-
Learn Ricochet
```

## Placing Devices

Once all of the devices have been learnt, they will need placing in their desired location, this should be done by installing devices closest to the Control Panel first and then working outwards so that the last devices installed are those furthest away from the control panel.

Make sure to install devices with the receiver in Commission mode

Devices also have a commission mode which will indicate a secure and valid path of communication to the receiver. (when the tamper circuit is closed the LED will flash to indicate communication, and then come on solid once communication has been established).



**NOTE** You should wait at least 20 minutes after installing the last device to make sure routing has been correctly established between all system devices.







## Finishing the Installation

Install all of the covers to the devices and the external sounder if fitted. and the proceed as follows:-

1. Remove the jumper link from Commission jumper on the panel PCB.
2. Fit the panel lid
3. Now test the system.

## Testing the System

Now that all of the devices and SmartKeys have been learned to the system, the system should be checked to ensure everything works as desired.

1. Press the /Menu key
2. Press **9** and then /Yes
3. Press **1** to do a Bell test and follow the instructions on the screen
4. Press /Menu key
5. Press **2** and then /Yes to walk test all of the devices



Once testing is complete Press /Menu and exit and log off of the system.















































































## Further Programming Options

### Quick Programming Guide

The tables below show all of the available programming options when in Engineering mode. Some examples of common changes required for a new installation are shown. Further detailed instructions can be found in INS176-X Premier Elite Installation Manual which is on the enclosed CD or available to download from our website.

Default Engineer Code (00)	1234
Default User Code (01)	5678

	<b>Log Off Engineer</b>
	Press  to log out of the Engineer Programming menu

	<b>Zone Setup</b>																						
	<table border="1"> <tr> <td><b>Zone Types</b></td> <td>Use <b>1</b> - <b>8</b> to enter zone number, <b>No</b> to edit, <b>0</b> - <b>9</b> or  to select a zone type, <b>Yes</b> to accept</td> </tr> <tr> <td><b>0</b></td> <td>Not Used  Medical  Conf PA audible</td> </tr> <tr> <td><b>1</b></td> <td>Entry/Exit 1  24Hr Gas  Conf PA silent</td> </tr> <tr> <td><b>2</b></td> <td>Entry/Exit 2  Auxiliary</td> </tr> <tr> <td><b>3</b></td> <td>Guard  Tamper</td> </tr> <tr> <td><b>4</b></td> <td>Guard Access  Exit Terminator</td> </tr> <tr> <td><b>5</b></td> <td>24Hr Audible  Moment Key</td> </tr> <tr> <td><b>6</b></td> <td>24Hr Silent  Latching Key</td> </tr> <tr> <td><b>7</b></td> <td>PA Audible  Security</td> </tr> <tr> <td><b>8</b></td> <td>PA Silent  Omit Key</td> </tr> <tr> <td><b>9</b></td> <td>Fire  Custom</td> </tr> </table>	<b>Zone Types</b>	Use <b>1</b> - <b>8</b> to enter zone number, <b>No</b> to edit, <b>0</b> - <b>9</b> or  to select a zone type, <b>Yes</b> to accept	<b>0</b>	Not Used  Medical  Conf PA audible	<b>1</b>	Entry/Exit 1  24Hr Gas  Conf PA silent	<b>2</b>	Entry/Exit 2  Auxiliary	<b>3</b>	Guard  Tamper	<b>4</b>	Guard Access  Exit Terminator	<b>5</b>	24Hr Audible  Moment Key	<b>6</b>	24Hr Silent  Latching Key	<b>7</b>	PA Audible  Security	<b>8</b>	PA Silent  Omit Key	<b>9</b>	Fire  Custom
<b>Zone Types</b>	Use <b>1</b> - <b>8</b> to enter zone number, <b>No</b> to edit, <b>0</b> - <b>9</b> or  to select a zone type, <b>Yes</b> to accept																						
<b>0</b>	Not Used  Medical  Conf PA audible																						
<b>1</b>	Entry/Exit 1  24Hr Gas  Conf PA silent																						
<b>2</b>	Entry/Exit 2  Auxiliary																						
<b>3</b>	Guard  Tamper																						
<b>4</b>	Guard Access  Exit Terminator																						
<b>5</b>	24Hr Audible  Moment Key																						
<b>6</b>	24Hr Silent  Latching Key																						
<b>7</b>	PA Audible  Security																						
<b>8</b>	PA Silent  Omit Key																						
<b>9</b>	Fire  Custom																						
	<table border="1"> <tr> <td><b>Zone Attributes 1</b></td> <td>Press <b>No</b> to edit, <b>1</b> - <b>8</b> to select an attribute, <b>Yes</b> to accept</td> </tr> <tr> <td><b>1</b></td> <td><b>O</b> = Omittable  <b>3</b> = Part 3 Omit</td> </tr> <tr> <td><b>2</b></td> <td><b>F</b> = Force Omit  <b>6</b> = Access</td> </tr> <tr> <td><b>3</b></td> <td><b>1</b> = Part 1 Omit  <b>7</b> = Entry/Exit 2</td> </tr> <tr> <td><b>4</b></td> <td><b>2</b> = Part 2 Omit  <b>8</b> = Guard</td> </tr> </table>	<b>Zone Attributes 1</b>	Press <b>No</b> to edit, <b>1</b> - <b>8</b> to select an attribute, <b>Yes</b> to accept	<b>1</b>	<b>O</b> = Omittable  <b>3</b> = Part 3 Omit	<b>2</b>	<b>F</b> = Force Omit  <b>6</b> = Access	<b>3</b>	<b>1</b> = Part 1 Omit  <b>7</b> = Entry/Exit 2	<b>4</b>	<b>2</b> = Part 2 Omit  <b>8</b> = Guard												
<b>Zone Attributes 1</b>	Press <b>No</b> to edit, <b>1</b> - <b>8</b> to select an attribute, <b>Yes</b> to accept																						
<b>1</b>	<b>O</b> = Omittable  <b>3</b> = Part 3 Omit																						
<b>2</b>	<b>F</b> = Force Omit  <b>6</b> = Access																						
<b>3</b>	<b>1</b> = Part 1 Omit  <b>7</b> = Entry/Exit 2																						
<b>4</b>	<b>2</b> = Part 2 Omit  <b>8</b> = Guard																						
	<table border="1"> <tr> <td><b>Zone Attributes 2</b></td> <td>Press <b>No</b> to edit, <b>1</b> - <b>8</b> to select an attribute, <b>Yes</b> to accept</td> </tr> <tr> <td><b>1</b></td> <td><b>D</b> = Double Knock  <b>1</b> = Reset</td> </tr> <tr> <td><b>2</b></td> <td><b>B</b> = Beam Pair  <b>6</b> = Auto Re-arm</td> </tr> <tr> <td><b>3</b></td> <td><b>S</b> = Soak Test  <b>7</b> = Quick Resp.</td> </tr> <tr> <td><b>4</b></td> <td><b>F</b> = Activity  <b>8</b> = Eng. Alarm</td> </tr> </table>	<b>Zone Attributes 2</b>	Press <b>No</b> to edit, <b>1</b> - <b>8</b> to select an attribute, <b>Yes</b> to accept	<b>1</b>	<b>D</b> = Double Knock  <b>1</b> = Reset	<b>2</b>	<b>B</b> = Beam Pair  <b>6</b> = Auto Re-arm	<b>3</b>	<b>S</b> = Soak Test  <b>7</b> = Quick Resp.	<b>4</b>	<b>F</b> = Activity  <b>8</b> = Eng. Alarm												
<b>Zone Attributes 2</b>	Press <b>No</b> to edit, <b>1</b> - <b>8</b> to select an attribute, <b>Yes</b> to accept																						
<b>1</b>	<b>D</b> = Double Knock  <b>1</b> = Reset																						
<b>2</b>	<b>B</b> = Beam Pair  <b>6</b> = Auto Re-arm																						
<b>3</b>	<b>S</b> = Soak Test  <b>7</b> = Quick Resp.																						
<b>4</b>	<b>F</b> = Activity  <b>8</b> = Eng. Alarm																						
	<table border="1"> <tr> <td><b>Key Attributes</b> (only applicable for keyswitch zone types)</td> <td>Press <b>No</b> to edit, <b>1</b> - <b>5</b> to select an attribute, <b>Yes</b> to accept</td> </tr> <tr> <td><b>1</b></td> <td><b>I</b> = Instant Arming  <b>5</b> = Silent Arming</td> </tr> <tr> <td><b>2</b></td> <td><b>P</b> = Part Arming  <b>6</b> = Time Arm Disable</td> </tr> <tr> <td><b>3</b></td> <td><b>F</b> = Full Disable  <b>7</b> = Key Tube (Monitor Only)</td> </tr> <tr> <td><b>4</b></td> <td><b>D</b> = Disarm Only</td> </tr> </table>	<b>Key Attributes</b> (only applicable for keyswitch zone types)	Press <b>No</b> to edit, <b>1</b> - <b>5</b> to select an attribute, <b>Yes</b> to accept	<b>1</b>	<b>I</b> = Instant Arming  <b>5</b> = Silent Arming	<b>2</b>	<b>P</b> = Part Arming  <b>6</b> = Time Arm Disable	<b>3</b>	<b>F</b> = Full Disable  <b>7</b> = Key Tube (Monitor Only)	<b>4</b>	<b>D</b> = Disarm Only												
<b>Key Attributes</b> (only applicable for keyswitch zone types)	Press <b>No</b> to edit, <b>1</b> - <b>5</b> to select an attribute, <b>Yes</b> to accept																						
<b>1</b>	<b>I</b> = Instant Arming  <b>5</b> = Silent Arming																						
<b>2</b>	<b>P</b> = Part Arming  <b>6</b> = Time Arm Disable																						
<b>3</b>	<b>F</b> = Full Disable  <b>7</b> = Key Tube (Monitor Only)																						
<b>4</b>	<b>D</b> = Disarm Only																						
	<table border="1"> <tr> <td><b>Custom Attributes</b></td> <td>Press <b>No</b> to edit, <b>1</b> - <b>5</b> to select an attribute, <b>Yes</b> to accept</td> </tr> </table>	<b>Custom Attributes</b>	Press <b>No</b> to edit, <b>1</b> - <b>5</b> to select an attribute, <b>Yes</b> to accept																				
<b>Custom Attributes</b>	Press <b>No</b> to edit, <b>1</b> - <b>5</b> to select an attribute, <b>Yes</b> to accept																						

	(only applicable for custom zone types)	<input type="radio"/> B = Bell/Strobe <input type="radio"/> I = Internals <input type="radio"/> M = Monitor 24Hr	<input type="radio"/> C = Enable Coms <input type="radio"/> W = Warning
<input type="radio"/>	<b>Zone Areas 24/48/88/168</b>	Press <input type="radio"/> to edit, <input type="radio"/> - <input type="radio"/> to select an area, ( <input type="radio"/> = all areas, <input type="radio"/> = areas A - H and I -P), <input type="radio"/> to accept.	
<input type="radio"/>	<b>Zone Areas 640</b>	Press <input type="radio"/> to edit, <input type="radio"/> or <input type="radio"/> to select an area group (1-4), use <input type="radio"/> to select areas A - H and I -P), <input type="radio"/> to accept.	
<input type="radio"/>	<b>Zone Text</b>	Press <input type="radio"/> to edit, <input type="radio"/> - <input type="radio"/> to select characters (press the required key the appropriate number of times), <input type="radio"/> to accept	
		<input type="radio"/> ., ? ! @ " - <input type="radio"/> A B C 2 <input type="radio"/> D E F 3 <input type="radio"/> G H I 4 <input type="radio"/> J K L 5	<input type="radio"/> M N O 6 <input type="radio"/> P Q R S 7 <input type="radio"/> T U V 8 <input type="radio"/> W X Y Z 9 <input type="radio"/> 0 _
			<input type="radio"/> Move Cursor <input type="radio"/> Copy Text to Memory <input type="radio"/> Paste Text from Memory <input type="radio"/> Upper, Lower Case, Predictive Text and Numerical
<input type="radio"/>	<b>Zone Chime</b>	Press <input type="radio"/> to alter chime tone, <input type="radio"/> to accept	
		<input type="radio"/> Silent	<input type="radio"/> Chime 1
		<input type="radio"/> Chime 2	<input type="radio"/> Chime 3
<input type="radio"/>	<b>Zone Test</b>	Press <input type="radio"/> to alter Test option, <input type="radio"/> to accept	
<input type="radio"/>	<b>Zone Wiring</b>	Press <input type="radio"/> to alter wiring type, <input type="radio"/> to accept	
		<input type="radio"/> Normally Open	<input type="radio"/> Triple EOL
		<input type="radio"/> Normally Cosed	<input type="radio"/> 1K/1K/(3K)
		<input type="radio"/> Double Pole EOL	<input type="radio"/> 4K7/6K8(12K)
		<input type="radio"/> 2K2/4K7/(6K8)	<input type="radio"/> 4K7/4K7
		<input type="radio"/> WD Monitor	

<input type="radio"/>	Area Programming																
<input type="radio"/>	<b>Timers</b>	Use <input type="radio"/> to select an area, <input type="radio"/> to select a timer, <input type="radio"/> - <input type="radio"/> to enter a value, <input type="radio"/> to accept															
		<table border="0"> <tr> <td>1: Exit Dly for Areas:</td> <td>6: Bell Duration for Areas:</td> </tr> <tr> <td>2: Entry Dly 1 for Areas:</td> <td>7: Coms Dly for Areas:</td> </tr> <tr> <td>3: Entry Dly 2 for Areas:</td> <td>8: Part Bell Dly for Areas:</td> </tr> <tr> <td>4: 2<sup>nd</sup> Entry Dly for Areas:</td> <td>9: Conf PA Timer for Areas:</td> </tr> <tr> <td>5: Bell Dly for Areas:</td> <td></td> </tr> </table>	1: Exit Dly for Areas:	6: Bell Duration for Areas:	2: Entry Dly 1 for Areas:	7: Coms Dly for Areas:	3: Entry Dly 2 for Areas:	8: Part Bell Dly for Areas:	4: 2 <sup>nd</sup> Entry Dly for Areas:	9: Conf PA Timer for Areas:	5: Bell Dly for Areas:						
1: Exit Dly for Areas:	6: Bell Duration for Areas:																
2: Entry Dly 1 for Areas:	7: Coms Dly for Areas:																
3: Entry Dly 2 for Areas:	8: Part Bell Dly for Areas:																
4: 2 <sup>nd</sup> Entry Dly for Areas:	9: Conf PA Timer for Areas:																
5: Bell Dly for Areas:																	
<input type="radio"/>	<b>Arming Modes</b>	Use <input type="radio"/> to select an area, <input type="radio"/> - <input type="radio"/> to select arming an mode, <input type="radio"/> to accept															
		<table border="0"> <tr> <td><input type="radio"/> Entry/Exit</td> <td><input type="radio"/> Instant</td> </tr> <tr> <td><input type="radio"/> Exit Term.</td> <td><input type="radio"/> Deferred</td> </tr> <tr> <td><input type="radio"/> Timed Exit</td> <td></td> </tr> </table>	<input type="radio"/> Entry/Exit	<input type="radio"/> Instant	<input type="radio"/> Exit Term.	<input type="radio"/> Deferred	<input type="radio"/> Timed Exit										
<input type="radio"/> Entry/Exit	<input type="radio"/> Instant																
<input type="radio"/> Exit Term.	<input type="radio"/> Deferred																
<input type="radio"/> Timed Exit																	
<input type="radio"/>	<b>Area Arm Suites 24/48/88/168</b>	Use <input type="radio"/> to select a suite, <input type="radio"/> no to edit, <input type="radio"/> - <input type="radio"/> to select an area, ( <input type="radio"/> = all areas, <input type="radio"/> = areas A - H and I - P), <input type="radio"/> to accept															
<input type="radio"/>	<b>Area Arm Suites 640</b>	Use <input type="radio"/> to select a suite, <input type="radio"/> no to edit, <input type="radio"/> - <input type="radio"/> to select an area group (1-4), use <input type="radio"/> to select areas A - H and I -P), <input type="radio"/> to accept.															
<input type="radio"/>	<b>Area Suite Text</b>	Use <input type="radio"/> - <input type="radio"/> to select a suite, <input type="radio"/> to edit, <input type="radio"/> - <input type="radio"/> to select characters (press the required key the appropriate number of times), <input type="radio"/> to accept															
		<table border="0"> <tr> <td><input type="radio"/> ., ? ! @ " -</td> <td><input type="radio"/> M N O 6</td> <td><input type="radio"/> Move Cursor</td> </tr> <tr> <td><input type="radio"/> A B C 2</td> <td><input type="radio"/> P Q R S 7</td> <td><input type="radio"/> Copy Text to Memory</td> </tr> <tr> <td><input type="radio"/> D E F 3</td> <td><input type="radio"/> T U V 8</td> <td><input type="radio"/> Paste Text from Memory</td> </tr> <tr> <td><input type="radio"/> G H I 4</td> <td><input type="radio"/> W X Y Z 9</td> <td><input type="radio"/> Upper, Lower Case, Predictive Text &amp; Numerical</td> </tr> <tr> <td><input type="radio"/> J K L 5</td> <td><input type="radio"/> 0 _</td> <td></td> </tr> </table>	<input type="radio"/> ., ? ! @ " -	<input type="radio"/> M N O 6	<input type="radio"/> Move Cursor	<input type="radio"/> A B C 2	<input type="radio"/> P Q R S 7	<input type="radio"/> Copy Text to Memory	<input type="radio"/> D E F 3	<input type="radio"/> T U V 8	<input type="radio"/> Paste Text from Memory	<input type="radio"/> G H I 4	<input type="radio"/> W X Y Z 9	<input type="radio"/> Upper, Lower Case, Predictive Text & Numerical	<input type="radio"/> J K L 5	<input type="radio"/> 0 _	
<input type="radio"/> ., ? ! @ " -	<input type="radio"/> M N O 6	<input type="radio"/> Move Cursor															
<input type="radio"/> A B C 2	<input type="radio"/> P Q R S 7	<input type="radio"/> Copy Text to Memory															
<input type="radio"/> D E F 3	<input type="radio"/> T U V 8	<input type="radio"/> Paste Text from Memory															
<input type="radio"/> G H I 4	<input type="radio"/> W X Y Z 9	<input type="radio"/> Upper, Lower Case, Predictive Text & Numerical															
<input type="radio"/> J K L 5	<input type="radio"/> 0 _																
<input type="radio"/>	<b>Suite Arm Mode</b>	Use <input type="radio"/> to select an area, <input type="radio"/> - <input type="radio"/> to select an arming mode, <input type="radio"/> to accept															
		<table border="0"> <tr> <td><input type="radio"/> Entry/Exit</td> <td><input type="radio"/> Instant</td> </tr> <tr> <td><input type="radio"/> Exit Term.</td> <td><input type="radio"/> Deferred</td> </tr> <tr> <td><input type="radio"/> Timed Exit</td> <td></td> </tr> </table>	<input type="radio"/> Entry/Exit	<input type="radio"/> Instant	<input type="radio"/> Exit Term.	<input type="radio"/> Deferred	<input type="radio"/> Timed Exit										
<input type="radio"/> Entry/Exit	<input type="radio"/> Instant																
<input type="radio"/> Exit Term.	<input type="radio"/> Deferred																
<input type="radio"/> Timed Exit																	
<input type="radio"/>	<b>Area Options</b>	<p><b>12/24/48/88/168</b></p> <p>Use <input type="radio"/> to select an option, <input type="radio"/> to edit, <input type="radio"/> - <input type="radio"/> to select an area, (<input type="radio"/> = all areas, <input type="radio"/> = areas A - H and I - P), <input type="radio"/> to accept</p> <p><b>640</b></p> <p>Use <input type="radio"/> to select an option, <input type="radio"/> no to edit, <input type="radio"/> - <input type="radio"/> to select an area group (1-4), use <input type="radio"/> to select areas A - H and I -P), <input type="radio"/> to accept.</p> <table border="0"> <tr> <td>01: Auto Part Arm</td> <td>21: Unarm Fire Coms</td> </tr> <tr> <td>02: Part Arm Instant</td> <td>22: Unarm Tamper Coms</td> </tr> <tr> <td>03: Part Arm Silent</td> <td>23: Auto Arm Areas</td> </tr> <tr> <td>04: Remote Arm</td> <td>24: Area A Foyer</td> </tr> </table>	01: Auto Part Arm	21: Unarm Fire Coms	02: Part Arm Instant	22: Unarm Tamper Coms	03: Part Arm Silent	23: Auto Arm Areas	04: Remote Arm	24: Area A Foyer							
01: Auto Part Arm	21: Unarm Fire Coms																
02: Part Arm Instant	22: Unarm Tamper Coms																
03: Part Arm Silent	23: Auto Arm Areas																
04: Remote Arm	24: Area A Foyer																

2 <sub>abc</sub>		Area Programming	
		05: Remote Disarm	25: Log Part Omits
		06: Panel Tamper	26: Multi Knock Area
		07: Bell Tamper	27: UDL Keypad
		08: Auxiliary Tamper	28: Auto Chime (C2A)
		09: Panel Speaker	29: Confirm in Entry
		10: Bell & Strobe op	30: Conf. After Entry
		11: Alarm Eng Reset	31: Enable Part Arms
		12: Confirmation Reset	32: Bell Squawk
		13: Tamper Eng Reset	33: Fob After Entry
		14: Anti-code Reset	34: Armed = Coms
		15: Phone Line Fault	35: 2-Wire Smoke
		16: Arm With L/Fault	36: Fault Eng Reset
		17: AC Mains Fail	37: L/Fault Eng Rst
		18: Arm With AC Fail	38: AC Fail Eng Rst
		19: Area Arm Coms	39: Anti-Masking When Armed
		20: Part Arm Coms	
6 <sub>ms</sub>	Time Arm Areas	Use <b>↔</b> to select an area, <b>Yes</b> to toggle between the arm and disarm timer, <b>1</b> - <b>8<sub>ms</sub></b> to select timers, <b>Yes</b> to	
7 <sub>ms</sub>	Area Text	Use <b>↔</b> to select an area, <b>No</b> to edit, <b>0</b> - <b>9<sub>ms</sub></b> to select characters (press the required key the appropriate number of times), <b>Yes</b> to accept	

3 <sub>def</sub>		Global Options	
0 <sub>ms</sub>	System Timers	Use <b>↔</b> to select a timer, <b>0</b> - <b>9<sub>ms</sub></b> to enter a value, <b>Yes</b> to accept	
		00: Exit Settle Time	12: Pulse Period 2
		01: Global Bell Dly.	13: Pulse Period 3
		02: Global Bell Dur.	14: Line Fault Delay
		03: Double Knock Dly	15: AC Off Delay
		04: Beam Pair Time	16: Batt Test Period
		05: Activity Delay	17: Batt Test Time
		06: Abort Delay	18: Soak Test Time
		07: Courtesy Time	19: Service Interval
		08: Defer Arming By	20: Test Call Every
		09: Auto Arm Delay	21: Min Random Time
		10: Menu Time Out	22: Max Random Time
		11: Pulse Period 1	23: Door Strike Time
		24: Zone Response	
		25: Keypad PA Delay	
		26: Confirmation Dly	
		27: Warning Delay	
		28: Keypad Lock Time	
		29: Eng. Log Off Dly	
		30: Fire Bell Delay	
		31: Forced Entry Dly	
		32: Supervision Time	
		33: Poll IP Every	
1 <sub>ms</sub>	System Config.	Use <b>↔</b> to select an option, <b>No</b> to change the option, <b>Yes</b> to accept	
		00: (No Bell/Bell on) Arm Fail	19: (Auto/Manual) Area Select
		01: Bell is an (SAB/SCB)	20: (Predictive/Normal) Text
		02: Clock is (12Hr/24Hr)	21: Zone Short=(Active/Tamper)
		03: (Manual/Auto) BST/GMT	22: R/R=(Reset Only/Silence/RST)
		04: (Hide/View) Armed Areas	23: User Codes (Pulse/Latch)
		05: (Area/Global) Bell Time	24: Test Call = (Timed/Unarmed)
		06: 24Hr Omit (Global/Local)	25: Batt Test = (Timed/Disarm)
		07: (Leave/Remove) Omits	26: Bell = (1 <sup>st</sup> Alarm/2 <sup>nd</sup> Alarm)
		08: Away (Override/Enforce)	27: SNDR = (1 <sup>st</sup> Alarm/2 <sup>nd</sup> Alarm)
		09: NVM is (Unlocked/Locked)	28: Conf. = (Instant/Delayed)
		10: Engineer (Only/+ User)	29: Abort = (Eng. Reset/User Reset)
		11: Chime (Audible/Visible)	30: (Auto/Manual) AV Outputs
		12: Omit Tamper (NO/YES)	31: Clock = (50Hz/Crystal)
		13: (Offline/Online) Printing	32: (40/80) Column Printer
		14: Activity Fault (View/Hide)	33: (Enable/Disable) Text
		15: (Hide/View) Exit Errors	34: EN50131 (Disabled/Enabled)
		16: (No/Enable) Code Tamper	35: (2 <sup>nd</sup> Zone /1 <sup>st</sup> Zone) = Confirm
		17: Code Tamp (Alarms/Locks)	36: (Global/Local) Keypads
		18: Areas (1-8/A-H) & I-P	37: Panel Grade (2/3)
		38: (Enable/Disable) RF FOB PA	
		39: Mask=(Fault/Alarm)	
		40: FOB PA (Audible/Silent)	
		41: PSU Batt (Monitor/No Fits)	
		42: Exp Loss Tamp (On/Off)	
		43: Soak Test Warn (On/Off)	
		44: Fob Batt Warn (On/Off)	
		45: Entry Stray (On/Off)	
		46: BS Entry Stray (On/Off)	
		47: Tamper = Confirmed (No Confirm/Confirm)	
		48: Radio 2 Step Arm (2 Steps/1 Step)	
		49: Radio Step1 (Zone/RKP)	
		50: Radio Step 2 (Fob/Zone)	
		51: Conf Hold Up (Enabled/None)	
		52: Max Log msgs (3/Off)	
		53: Code entry timed (On/Off)	
		54: PD6662:2010 (On/Off)	
2 <sub>ms</sub>	System Options	Use <b>↔</b> to select an Option, <b>0</b> - <b>9<sub>ms</sub></b> to enter a value, <b>Yes</b> to accept	
		0: Advisory Volume	4: Multiple Knocks
			8: Language

3 <sub>Set</sub>		Global Options		
		1: Chime Volume	5: Adjust Clock	9: Country Code & Defaults
		2: Number Of Re-Arms	6: Quick Count	
		3: Anti-code Resets	7: Modem Level	
3 <sub>Set</sub>	Monitor Hardware	Press <b>No</b> to edit, <b>↕</b> to select an option, <b>No</b> to change the option, <b>Yes</b> to accept		
		1 P = Line Fault	4 <sub>Set</sub> B = Bell Tamper	7 <sub>Set</sub> B = Battery Faults
		2 <sub>Set</sub> A = AC Power Failure	5 <sub>Set</sub> A = Aux Tamper	
		3 <sub>Set</sub> F = Aux Fuse Blown	6 <sub>Set</sub> L = Panel Lid Tamper	
4 <sub>Set</sub>	Control Timers	Use <b>↕</b> to select an area, <b>0</b> - <b>9</b> to enter the 1 <sup>st</sup> On time, <b>Yes</b> to accept		
		Use <b>1</b> - <b>7</b> to select the 1 <sup>st</sup> On time days of operation, <b>Yes</b> to accept		
		Use <b>0</b> - <b>9</b> to enter the 1 <sup>st</sup> Off time, <b>Yes</b> to accept		
		Use <b>1</b> - <b>7</b> to select the 1 <sup>st</sup> Off time days of operation, <b>Yes</b> to accept		
5 <sub>Set</sub>	System Text	Use <b>↕</b> to select a message, <b>0</b> - <b>9</b> to select characters (press the required key the appropriate number of times), <b>Yes</b> to accept		
6 <sub>Set</sub>	Part Arm Text	Use <b>↕</b> to select a Part Arm, <b>No</b> to edit the Part Arm text, <b>0</b> - <b>9</b> to select characters (press the required key the appropriate number of times), <b>Yes</b> to accept		
7 <sub>Set</sub>	Holiday Dates	Use <b>↕</b> to select a holiday date, <b>0</b> - <b>9</b> to enter the required date ( <b>D</b> <b>D</b> <b>M</b> <b>M</b> <b>Y</b> <b>Y</b> ), <b>Yes</b> to accept		
8 <sub>Set</sub>	Speaker Tones	Use <b>↕</b> to select a tone type, <b>No</b> to turn the tone on/off, <b>Yes</b> to accept		
9 <sub>Set</sub>	PC Output Text	Use <b>↕</b> to select an Output, <b>No</b> to edit, <b>0</b> - <b>9</b> to select characters (press the required key the appropriate number of times), <b>Yes</b> to accept		
↕	Custom O/P Text	Use <b>↕</b> to select an Output, <b>No</b> to edit, <b>0</b> - <b>9</b> to select characters (press the required key the appropriate number of times), <b>Yes</b> to accept		

4 <sub>Set</sub>		Keypad Setup		
Yes	Areas 12/ 24/48/88/168	Use <b>1</b> - <b>8</b> to select keypad, <b>0</b> to select network, <b>No</b> to edit, <b>1</b> - <b>8</b> to select an area, ( <b>0</b> = all areas, <b>Area</b> = areas A - H and I -P), <b>Yes</b> to accept		
Yes	Areas 640	Use <b>1</b> - <b>8</b> to select keypad, <b>0</b> to select network, <b>No</b> to edit, <b>Chime</b> - <b>Part</b> to select an area group (1-4), use <b>Area</b> to select areas A - H and I -P), <b>Yes</b> to accept.		
Yes	Zone Mapping	Press <b>No</b> to edit, <b>1</b> - <b>8</b> to enter zone number, <b>Yes</b> to accept, Repeat for 2 <sup>nd</sup> zone		
Yes	Options	Press <b>No</b> to edit, <b>↕</b> to select an option, <b>No</b> to change the option, <b>Yes</b> to accept		
		1 P = PA Enabled	5 <sub>Set</sub> A = PA is Audible	
		2 <sub>Set</sub> F = Fire Enabled	6 <sub>Set</sub> D = PA is Delayed	
		3 <sub>Set</sub> F = Medical Enabled	7 <sub>Set</sub> Q = Quick Arm On	
		4 <sub>Set</sub> T = Tamper Enabled	8 <sub>Set</sub> O = Info.LED>Output	
Yes	Volume	Press <b>No</b> to edit, <b>0</b> - <b>8</b> to enter a value, <b>Yes</b> to accept		
Yes	Sounder Options	Press <b>No</b> to edit, <b>↕</b> to select an option, <b>No</b> to change the option, <b>Yes</b> to accept		
		1 F = Fire Tones Enabled	5 <sub>Set</sub> E = Entry Tones Enabled	
		2 <sub>Set</sub> A = Alarm Tones Enabled	6 <sub>Set</sub> X = Exit Tones Enabled	
		3 <sub>Set</sub> F = Fault Tones Enabled	7 <sub>Set</sub> C = Chime Tones Enabled	
		4 <sub>Set</sub> S = Service Tones Enabled	8 <sub>Set</sub> K = Use Keypad Areas	

5 <sub>Set</sub>		Expander Setup		
Yes	Areas 12/24/48/88/168	Use <b>1</b> - <b>8</b> to select expander, <b>0</b> to select network, <b>No</b> to edit, <b>1</b> - <b>8</b> to select an area, ( <b>0</b> = all areas, <b>Area</b> = areas A - H and I -P), <b>Yes</b> to accept		
Yes	Areas 640	Use <b>1</b> - <b>8</b> to select expander, <b>0</b> to select network, <b>No</b> to edit, <b>Chime</b> - <b>Part</b> to select an area group (1-4), use <b>Area</b> to select areas A - H and I -P), <b>Yes</b> to accept.		
Yes	Text	Press <b>No</b> to edit text, <b>0</b> - <b>9</b> to select characters (press the required key the appropriate number of times), <b>Yes</b> to accept		
		1 ., ? ! 1 @ " -	6 <sub>Set</sub> M N O 6	↕ Move Cursor
		2 <sub>Set</sub> A B C 2	7 <sub>Set</sub> P Q R S 7	Chime Copy Text to Memory
		3 <sub>Set</sub> D E F 3	8 <sub>Set</sub> T U V 8	Part Paste Text from Memory
		4 <sub>Set</sub> G H I 4	9 <sub>Set</sub> W X Y Z 9	No Upper, Lower Case, Predictive Text & Numerical
		5 <sub>Set</sub> J K L 5	0 0 _	
Yes	Auxiliary Input	Press <b>No</b> to edit, <b>0</b> - <b>7</b> to select an input type, <b>Yes</b> to accept		
		0 Not Used	6 <sub>Set</sub> Silence Sounders	
		1 Auxiliary Tamper	7 <sub>Set</sub> Global Omit Key	
		2 <sub>Set</sub> Bell Tamper	8 <sub>Set</sub> Local Omit Key	

5 <input type="radio"/>		Expander Setup	
		<input type="radio"/> Remote Reset <input type="radio"/> Line Fault +ve <input type="radio"/> Line Fault -ve	<input type="radio"/> PSU Monitor <input type="radio"/> Defer Auto Arming
<input type="radio"/> Yes	Volume	Press <input type="radio"/> No to edit, <input type="radio"/> 0 - <input type="radio"/> 8 to enter a value, <input type="radio"/> Yes to accept	
<input type="radio"/> Yes	Sounder Options	Press <input type="radio"/> No to edit, <input type="radio"/> to select an option, <input type="radio"/> No to change the option, <input type="radio"/> Yes to accept	
		<input type="radio"/> F = Fire Tones Enabled <input type="radio"/> A = Alarm Tones Enabled <input type="radio"/> F = Fault Tones Enabled <input type="radio"/> S = Service Tones Enabled	<input type="radio"/> E = Entry Tones Enabled <input type="radio"/> X = Exit Tones Enabled <input type="radio"/> C = Chime Tones Enabled

6 <input type="radio"/>		System Outputs	
<input type="radio"/> Panel Outputs <input type="radio"/> Digi Outputs <input type="radio"/> Com? Channels <input type="radio"/> RedCARE Pins		Use <input type="radio"/> 1 - <input type="radio"/> 8 to select an output, <input type="radio"/> No to edit, <input type="radio"/> 1 - <input type="radio"/> 7 to enter an output group, <input type="radio"/> 0 - <input type="radio"/> 9 to enter output type, <input type="radio"/> Yes to accept	
<input type="radio"/> Keypad Outputs		Use <input type="radio"/> 1 - <input type="radio"/> 8 to select device, <input type="radio"/> 0 to select network, <input type="radio"/> to select an output, <input type="radio"/> No to edit, <input type="radio"/> 1 - <input type="radio"/> 7 to enter an output group, <input type="radio"/> 0 - <input type="radio"/> 9 to enter output type, <input type="radio"/> Yes to accept	
<input type="radio"/> Expander Outputs			
<input type="radio"/> Custom Outputs		Use <input type="radio"/> 0 to select output, <input type="radio"/> 1 - <input type="radio"/> 8 to select a switch, <input type="radio"/> No to edit, <input type="radio"/> 1 - <input type="radio"/> 7 to enter an output group, <input type="radio"/> 0 - <input type="radio"/> 9 to enter output type, <input type="radio"/> Yes to accept	
<input type="radio"/> X-10 Outputs		Use <input type="radio"/> 1 - <input type="radio"/> 8 to select an output, <input type="radio"/> No to edit, <input type="radio"/> 1 - <input type="radio"/> 7 to enter an output group, <input type="radio"/> 0 - <input type="radio"/> 9 to enter output type, <input type="radio"/> 0 - <input type="radio"/> 9 to enter House/device Number, <input type="radio"/> Yes to accept	

Key	Output Group	Outputs Types
<input type="radio"/> 0	Not Used:	Press <input type="radio"/> Yes to accept
<input type="radio"/> 1	System:	Use <input type="radio"/> 0 - <input type="radio"/> 9 to enter an output type or use <input type="radio"/> to search, <input type="radio"/> Yes to accept 00: Phone Line Fault    18: UDL Lockout    35: Custom 4 Stage A 01: Mains Power Off    19: UDL Call Active    36: Custom 4 Stage B 02: Aux Fuse Fault    20: UDL Enabled    37: Custom 4 Stage AB 03: Auxiliary Tamper    21: Confirmed Alarm    38: Com 1 Fault 04: Bell Tamper    22: Custom 1 Stage A    39: Com 2 Fault 05: Panel Lid Tamper    23: Custom 1 Stage B    40: Com 1 No Signal 06: Engineer Working    24: Custom 1 Stage AB    41: Com 2 No Signal 07: Confirm Devices    25: Custom 2 Stage A    42: Coms Fault 08: Service Required    26: Custom 2 Stage B    43: Radio Jamming 09: Bell Fuse Blown    27: Custom 2 Stage AB    46: Radio RX Tamper 10: Battery Fault    28: Radio-Pad Failed    47: Detector Test 11: Battery Test On    30: No Radio Signal    48: ATS Remote Test 12: Courtesy Light    31: Radio-Pad Lost    49: Dual Path Fault 13: System Open    30: No Radio Signal    50: CIE Fault 14: Fully Arm    31: Radio-Pad Lost    51: PSU Fuse Blown 15: Digi Failed    32: Custom 3 Stage A    52: PSU Battery Fit 16: Digi Successful    33: Custom 3 Stage B    53: WD Test Active 17: Digi Active    34: Custom 3 Stage AB
<input type="radio"/> 2	Area:	12/24/48/88/168 Use <input type="radio"/> 0 - <input type="radio"/> 9 to enter an output type or use <input type="radio"/> to search, <input type="radio"/> 1 - <input type="radio"/> 8 to select an area, ( <input type="radio"/> 0 = all areas, <input type="radio"/> Area = areas A - H and I -P), <input type="radio"/> Yes to accept 640 Use <input type="radio"/> 0 - <input type="radio"/> 9 to enter an output type or use <input type="radio"/> to search, <input type="radio"/> to select an area, <input type="radio"/> Yes to accept type, <input type="radio"/> Chime - <input type="radio"/> Part to select an area group (1-4), use <input type="radio"/> Area to select areas A - H and I -P), <input type="radio"/> Yes to accept. 00: Intruder Alarm    19: Exit Mode    38: Chime Mimic    57: Zones Locked Out 01: Guard 1 Alarm    20: Entry/Exit Mode    39: Chime Enabled    58: All Armed 02: Guard 2 Alarm    21: Armed    40: DK First Knock    59: Auto Arm Disable 03: Entry Alarm    22: Full Arm    41: BP First Knock    60: Armed / Alarm 04: Confirmed Alarm    23: Part Armed    42: On Test    61: Intruder Alarm 05: 24Hr Audible    24: Part Arming    43: Test Fail    62: Speaker Mimic 06: 24Hr Silent    25: Force Arm    44: Internal Alarm    63: Full Arm/Exit 07: 24Hr Gas    26: Force Arming    45: Auto Arming    64: Detector Fault

		08: PA Audible	27: Arm Fail	46: Time Arming	65: Detector Mask
		09: PA Silent	28: Bell SAB	47: 1 <sup>st</sup> Code Entered	66: Fault Present
		10: Duress	29: Bell SCB	48: 2 <sup>nd</sup> Code Entered	67: LED Control
		11: Fire Alarm	30: Strobe	49: Area Secured	68: Full Armed Entry
		12: Medical	31: Switch 12 Volts	50: Part Armed 1	69: Fire Sounder
		13: Auxiliary Alarm	32: Detector Reset	51: Part Armed 2	70: Confirmed PA
		14: Tamper Alarm	33: Walk Test Active	52: Part Armed 3	71: Confirmed Intruder
		15: Alarm Abort	34: Zones Omitted	53: Custom Alarm	
		16: Ready	35: 24Hr Zones Omit	54: Zone Warning	
		17: Entry Mode	36: Reset Required	55: Arm Fail Warning	
		18: 2 <sup>nd</sup> Entry Mode	37: Door Strike	56: Forced Entry	
3 <sub>sec</sub>	<b>Zone:</b>	Use 1 - 8 to enter a zone number or use $\uparrow$ to search, 0 - 5 to select a zone output type, Yes to accept			
		1 Mimic	3 <sub>sec</sub> Alarm	5 <sub>sec</sub> MimicLatch	
		2 <sub>sec</sub> MimicArm	4 <sub>sec</sub> Tamper	6 <sub>sec</sub> Omitted	
4 <sub>sec</sub>	<b>User:</b>	Use 1 - 8 to select a User code or use $\uparrow$ to search, Yes to accept			
5 <sub>sec</sub>	<b>Control Timer:</b>	Use 1 - 8 to select a Control Timer, Yes to accept			
6 <sub>sec</sub>	<b>PC Control:</b>	Use 1 - 8 to select a PC Control, Yes to accept			
7 <sub>sec</sub>	<b>Door Control:</b>	Use 1 - 8 to select a Door Control, Yes to accept			
8 <sub>sec</sub>	<b>X-10:</b>	Use 1 - 8 to select a an X-10 Output, Yes to accept			

Key	Attributes	Attribute Types																
Yes	Attributes	Press Yes to edit, 1 - 8 to select attributes, Yes to accept																
		<table> <tr> <td>1</td> <td>U = User Test</td> <td>5<sub>sec</sub></td> <td>2 = Use Pulse Timer 2</td> </tr> <tr> <td>2<sub>sec</sub></td> <td>I = Inverted</td> <td>6<sub>sec</sub></td> <td>3 = Use Pulse Timer 3</td> </tr> <tr> <td>3<sub>sec</sub></td> <td>L = Latching</td> <td>7<sub>sec</sub></td> <td>C = Custom Output 1, Stage A</td> </tr> <tr> <td>4<sub>sec</sub></td> <td>1 = Use Pulse Timer 1</td> <td>8<sub>sec</sub></td> <td>R = Random</td> </tr> </table>	1	U = User Test	5 <sub>sec</sub>	2 = Use Pulse Timer 2	2 <sub>sec</sub>	I = Inverted	6 <sub>sec</sub>	3 = Use Pulse Timer 3	3 <sub>sec</sub>	L = Latching	7 <sub>sec</sub>	C = Custom Output 1, Stage A	4 <sub>sec</sub>	1 = Use Pulse Timer 1	8 <sub>sec</sub>	R = Random
1	U = User Test	5 <sub>sec</sub>	2 = Use Pulse Timer 2															
2 <sub>sec</sub>	I = Inverted	6 <sub>sec</sub>	3 = Use Pulse Timer 3															
3 <sub>sec</sub>	L = Latching	7 <sub>sec</sub>	C = Custom Output 1, Stage A															
4 <sub>sec</sub>	1 = Use Pulse Timer 1	8 <sub>sec</sub>	R = Random															

7 <sub>sec</sub>		UDL/Digi Options												
0 <sub>sec</sub>	<b>Reset Digi</b>	Press Yes to reset communicator												
1	<b>Start Test call</b>	Press Yes to send test call to the ARC, 1 - 3 to initiate a call to the remote UDL computer (using Call Back numbers 1, 2 or 3)												
2 <sub>sec</sub>	<b>Msn Pre Dial Number</b>	Press No to edit, enter call waiting number, Yes to accept												
		<table> <tr> <td>0<sub>sec</sub> - 9<sub>sec</sub></td> <td>= Numbers 0 to 9</td> <td>Chime</td> <td>Insert a '#'</td> </tr> <tr> <td>No</td> <td>then Yes = Clear Screen</td> <td>Part</td> <td>, (3 Second pause)</td> </tr> <tr> <td>Omit</td> <td>Insert a '*'</td> <td>Area</td> <td>W (10 Second pause)</td> </tr> </table>	0 <sub>sec</sub> - 9 <sub>sec</sub>	= Numbers 0 to 9	Chime	Insert a '#'	No	then Yes = Clear Screen	Part	, (3 Second pause)	Omit	Insert a '*'	Area	W (10 Second pause)
0 <sub>sec</sub> - 9 <sub>sec</sub>	= Numbers 0 to 9	Chime	Insert a '#'											
No	then Yes = Clear Screen	Part	, (3 Second pause)											
Omit	Insert a '*'	Area	W (10 Second pause)											
3 <sub>sec</sub>	<b>Program Digi</b>	Use $\uparrow$ to select ARC sets 1 - 3, No to edit												
	<b>Protocol</b>	Press No to edit, 0 - 4 to select protocol, Yes to accept												
		<table> <tr> <td>0<sub>sec</sub></td> <td>Disabled</td> <td>2<sub>sec</sub></td> <td>Contact ID</td> <td>4<sub>sec</sub></td> <td>EasyCom Pager</td> </tr> <tr> <td>1</td> <td>Fast Format</td> <td>3<sub>sec</sub></td> <td>SIA Level II</td> <td>5<sub>sec</sub></td> <td>SMS</td> </tr> </table>	0 <sub>sec</sub>	Disabled	2 <sub>sec</sub>	Contact ID	4 <sub>sec</sub>	EasyCom Pager	1	Fast Format	3 <sub>sec</sub>	SIA Level II	5 <sub>sec</sub>	SMS
0 <sub>sec</sub>	Disabled	2 <sub>sec</sub>	Contact ID	4 <sub>sec</sub>	EasyCom Pager									
1	Fast Format	3 <sub>sec</sub>	SIA Level II	5 <sub>sec</sub>	SMS									
	<b>Primary Number</b>	Press No to edit, 0 - 9 to enter telephone number, Yes to accept												
	<b>Secondary Number</b>	Press No to edit, 0 - 9 to enter number, Yes to accept												
	<b>Account Number</b>	Press No to edit, 0 - 9 to enter number, Yes to accept												
	<b>Dialling Attempts</b>	Press No to edit, 0 - 9 to enter number, Yes to accept												
	<b>Reporting Channels</b>	Press No to edit, 1 - 8 to select channels, Yes to accept (only available for Fast Format)												
	<b>Restoring Channels</b>	Press No to edit, 1 - 8 to select channels, Yes to accept (only available for Fast Format)												
	<b>Open/Close Channels</b>	Press No to edit, 1 - 8 to select channels, Yes to accept (only available for Fast Format)												
	<b>Reporting Areas 12/24/48/88/168</b>	Press No to edit, 1 - 8 to select an area, (0 = all areas, Area = areas A - H and I - P), Yes to accept (only available for Contact ID, SIA Level II, EasyCom Pager and SMS Messaging)												
	<b>Reporting Areas 640</b>	Press No to edit, Chime - Part to select an area group (1-4), use Area to select areas A - H and I - P), Yes to accept. (only available for Contact ID, SIA Level II, EasyCom Pager and SMS Messaging)												
	<b>Reporting Options</b>	Press No to edit, 1 - 8 to select option, Yes to accept (only available for Contact ID, SIA Level II, EasyCom Pager and SMS Messaging)												
		<table> <tr> <td>1</td> <td>P = Priority Alarms</td> <td>5<sub>sec</sub></td> <td>M = Maintenance</td> </tr> <tr> <td>2<sub>sec</sub></td> <td>A = Normal Alarms</td> <td>6<sub>sec</sub></td> <td>T = Tamper Alarms</td> </tr> <tr> <td>3<sub>sec</sub></td> <td>C = Open/Close</td> <td>7<sub>sec</sub></td> <td>C = Test Calls</td> </tr> </table>	1	P = Priority Alarms	5 <sub>sec</sub>	M = Maintenance	2 <sub>sec</sub>	A = Normal Alarms	6 <sub>sec</sub>	T = Tamper Alarms	3 <sub>sec</sub>	C = Open/Close	7 <sub>sec</sub>	C = Test Calls
1	P = Priority Alarms	5 <sub>sec</sub>	M = Maintenance											
2 <sub>sec</sub>	A = Normal Alarms	6 <sub>sec</sub>	T = Tamper Alarms											
3 <sub>sec</sub>	C = Open/Close	7 <sub>sec</sub>	C = Test Calls											





7 <small>steps</small>		UDL/Digi Options																
	Pad NUA	View only																
	Forward Signal	View only																
	Reverse Signal	View only																
	Bit Error Rate	View only																
	Cyclic Redundancy	View only																
	GSM Signal/BER	View only																
	Com1,2,3	Press <b>(Reset)</b> to reset com port																
8 <small>steps</small>	<b>Com Port Setup</b>	Use <b>(0-9)</b> to select a com port, <b>(No)</b> to edit, <b>(↕)</b> to select an option, <b>(Yes)</b> to accept																
	Onboard Digi Port	<table border="0"> <tr> <td><b>(0)</b> Nothing Fitted</td> <td><b>(5)</b> Modem Unit</td> <td><b>(↕)</b> RadioPlus</td> </tr> <tr> <td><b>(1)</b> Com300</td> <td><b>(6)</b> Radio-pad</td> <td><b>(↕)</b> Inovonics Radio</td> </tr> <tr> <td><b>(2)</b> Com2400</td> <td><b>(7)</b> GSM Module</td> <td><b>(↕)</b> WebWayOne/Emizon Module</td> </tr> <tr> <td><b>(3)</b> ComISDN</td> <td><b>(8)</b> Crestron System</td> <td><b>(↕)</b> X-10 Control</td> </tr> <tr> <td><b>(4)</b> ComIP</td> <td><b>(9)</b> SIP</td> <td><b>(↕)</b> IRIS IP Module</td> </tr> </table>	<b>(0)</b> Nothing Fitted	<b>(5)</b> Modem Unit	<b>(↕)</b> RadioPlus	<b>(1)</b> Com300	<b>(6)</b> Radio-pad	<b>(↕)</b> Inovonics Radio	<b>(2)</b> Com2400	<b>(7)</b> GSM Module	<b>(↕)</b> WebWayOne/Emizon Module	<b>(3)</b> ComISDN	<b>(8)</b> Crestron System	<b>(↕)</b> X-10 Control	<b>(4)</b> ComIP	<b>(9)</b> SIP	<b>(↕)</b> IRIS IP Module	
	<b>(0)</b> Nothing Fitted	<b>(5)</b> Modem Unit	<b>(↕)</b> RadioPlus															
<b>(1)</b> Com300	<b>(6)</b> Radio-pad	<b>(↕)</b> Inovonics Radio																
<b>(2)</b> Com2400	<b>(7)</b> GSM Module	<b>(↕)</b> WebWayOne/Emizon Module																
<b>(3)</b> ComISDN	<b>(8)</b> Crestron System	<b>(↕)</b> X-10 Control																
<b>(4)</b> ComIP	<b>(9)</b> SIP	<b>(↕)</b> IRIS IP Module																
Com Ports 1, 2 & 3* * 640 only																		
<b>Expansion Port</b>	<b>(0)</b> Nothing Fitted	<b>(2)</b> ID Module	<b>(4)</b> Memory Module															
	<b>(1)</b> AV Module	<b>(3)</b> X10 Module																

8 <small>steps</small>		Setup Users																
<b>(Yes)</b>	<b>Select User</b>	Use <b>(0-9)</b> to enter enter a user number, <b>(Reset)</b> to Delete User, <b>(Omit)</b> to assign a Radio FOB, <b>(Chime)</b> to Copy a TAG, <b>(Part)</b> to Import a TAG, <b>(Yes)</b> to enter a Code																
<b>(Yes)</b>	<b>User Code</b>	Use <b>(0-9)</b> to enter a code, <b>(Yes)</b> to accept																
<b>(Yes)</b>	<b>User Areas 24/48/88/168</b>	Use <b>(1-8)</b> to select an area, <b>(0)</b> = all areas, <b>(Area)</b> = areas A - H and I -P, <b>(Yes)</b> to accept																
	<b>User Areas 640</b>	Use <b>(Chime)</b> - <b>(Part)</b> to select an area group (1-4), use <b>(Area)</b> to select areas A - H and I -P, <b>(Yes)</b> to accept.																
<b>(Yes)</b>	<b>User Types</b>	Use <b>(0-9)</b> to select a user type, <b>(Yes)</b> to accept																
		<table border="0"> <tr> <td><b>(1)</b> Master</td> <td><b>(5)</b> Arm Only</td> <td><b>(9)</b> Custom</td> </tr> <tr> <td><b>(2)</b> Manager</td> <td><b>(6)</b> Duress</td> <td><b>(0)</b> Engineer</td> </tr> <tr> <td><b>(3)</b> Standard</td> <td><b>(7)</b> Door Strike</td> <td></td> </tr> <tr> <td><b>(4)</b> Local</td> <td><b>(8)</b> Vacation</td> <td></td> </tr> </table>	<b>(1)</b> Master	<b>(5)</b> Arm Only	<b>(9)</b> Custom	<b>(2)</b> Manager	<b>(6)</b> Duress	<b>(0)</b> Engineer	<b>(3)</b> Standard	<b>(7)</b> Door Strike		<b>(4)</b> Local	<b>(8)</b> Vacation					
<b>(1)</b> Master	<b>(5)</b> Arm Only	<b>(9)</b> Custom																
<b>(2)</b> Manager	<b>(6)</b> Duress	<b>(0)</b> Engineer																
<b>(3)</b> Standard	<b>(7)</b> Door Strike																	
<b>(4)</b> Local	<b>(8)</b> Vacation																	
<b>(Yes)</b>	<b>User Options 1</b>	Press <b>(No)</b> to edit, <b>(↕)</b> to select an option, <b>(No)</b> to change option, <b>(Yes)</b> to accept																
		<table border="0"> <tr> <td><b>(1)</b> A = Arming</td> <td><b>(4)</b> R = Eng. Reset</td> <td><b>(7)</b> Y = Auto 'YES'</td> </tr> <tr> <td><b>(2)</b> D = Disarming</td> <td><b>(5)</b> a = Local Arming</td> <td><b>(8)</b> D = Disarm First</td> </tr> <tr> <td><b>(3)</b> O = Omitting</td> <td><b>(6)</b> d = Local Disarming</td> <td></td> </tr> </table>	<b>(1)</b> A = Arming	<b>(4)</b> R = Eng. Reset	<b>(7)</b> Y = Auto 'YES'	<b>(2)</b> D = Disarming	<b>(5)</b> a = Local Arming	<b>(8)</b> D = Disarm First	<b>(3)</b> O = Omitting	<b>(6)</b> d = Local Disarming								
<b>(1)</b> A = Arming	<b>(4)</b> R = Eng. Reset	<b>(7)</b> Y = Auto 'YES'																
<b>(2)</b> D = Disarming	<b>(5)</b> a = Local Arming	<b>(8)</b> D = Disarm First																
<b>(3)</b> O = Omitting	<b>(6)</b> d = Local Disarming																	
<b>(Yes)</b>	<b>User Options 2</b> (only available to Custom users)	Press <b>(No)</b> to edit, <b>(↕)</b> to select an option, <b>(No)</b> to change option, <b>(Yes)</b> to accept																
		<table border="0"> <tr> <td><b>(1)</b> U = User Menu</td> <td><b>(4)</b> V = Vacation</td> <td><b>(7)</b> C = Duress Code</td> </tr> <tr> <td><b>(2)</b> E = Eng. Program</td> <td><b>(5)</b> S = Door strike</td> <td><b>(8)</b> O = Open/Close</td> </tr> <tr> <td><b>(3)</b> D = Dual Code</td> <td><b>(6)</b> R = Call Rem. PC</td> <td></td> </tr> </table>	<b>(1)</b> U = User Menu	<b>(4)</b> V = Vacation	<b>(7)</b> C = Duress Code	<b>(2)</b> E = Eng. Program	<b>(5)</b> S = Door strike	<b>(8)</b> O = Open/Close	<b>(3)</b> D = Dual Code	<b>(6)</b> R = Call Rem. PC								
<b>(1)</b> U = User Menu	<b>(4)</b> V = Vacation	<b>(7)</b> C = Duress Code																
<b>(2)</b> E = Eng. Program	<b>(5)</b> S = Door strike	<b>(8)</b> O = Open/Close																
<b>(3)</b> D = Dual Code	<b>(6)</b> R = Call Rem. PC																	
<b>(Yes)</b>	<b>User Config.</b> (only available to Custom users with User Menu)	Press <b>(No)</b> to edit, <b>(↕)</b> to select an option, <b>(No)</b> to change option, <b>(Yes)</b> to accept																
		<table border="0"> <tr> <td><b>(1)</b> C = Change Code</td> <td><b>(4)</b> S = System tests</td> <td><b>(7)</b> A = Add Eng. Code</td> </tr> <tr> <td><b>(2)</b> Z = Chime Zones</td> <td><b>(5)</b> U = Setup Users</td> <td><b>(8)</b> N = NVM Locking</td> </tr> <tr> <td><b>(3)</b> T = Change Timer</td> <td><b>(6)</b> E = Eng. Access</td> <td></td> </tr> </table>	<b>(1)</b> C = Change Code	<b>(4)</b> S = System tests	<b>(7)</b> A = Add Eng. Code	<b>(2)</b> Z = Chime Zones	<b>(5)</b> U = Setup Users	<b>(8)</b> N = NVM Locking	<b>(3)</b> T = Change Timer	<b>(6)</b> E = Eng. Access								
<b>(1)</b> C = Change Code	<b>(4)</b> S = System tests	<b>(7)</b> A = Add Eng. Code																
<b>(2)</b> Z = Chime Zones	<b>(5)</b> U = Setup Users	<b>(8)</b> N = NVM Locking																
<b>(3)</b> T = Change Timer	<b>(6)</b> E = Eng. Access																	
<b>(Yes)</b>	<b>User Time Lock</b>	Use <b>(1-8)</b> to select a control timer, <b>(Yes)</b> to accept																
<b>(Yes)</b>	<b>User Text</b>	Press <b>(No)</b> to edit, <b>(0-9)</b> to select characters (press the required key the appropriate number of times), <b>(Yes)</b> to accept																
		<table border="0"> <tr> <td><b>(1)</b> . , ? ! 1 @ " -</td> <td><b>(6)</b> M N O 6</td> <td><b>(↕)</b> Move Cursor</td> </tr> <tr> <td><b>(2)</b> A B C 2</td> <td><b>(7)</b> P Q R S 7</td> <td><b>(Chime)</b> Copy Text to Memory</td> </tr> <tr> <td><b>(3)</b> D E F 3</td> <td><b>(8)</b> T U V 8</td> <td><b>(Part)</b> Paste Text from Memory</td> </tr> <tr> <td><b>(4)</b> G H I 4</td> <td><b>(9)</b> W X Y Z 9</td> <td><b>(No)</b> Upper, Lower Case, Predictive Text &amp; Numerical</td> </tr> <tr> <td><b>(5)</b> J K L 5</td> <td><b>(0)</b> 0 _</td> <td></td> </tr> </table>	<b>(1)</b> . , ? ! 1 @ " -	<b>(6)</b> M N O 6	<b>(↕)</b> Move Cursor	<b>(2)</b> A B C 2	<b>(7)</b> P Q R S 7	<b>(Chime)</b> Copy Text to Memory	<b>(3)</b> D E F 3	<b>(8)</b> T U V 8	<b>(Part)</b> Paste Text from Memory	<b>(4)</b> G H I 4	<b>(9)</b> W X Y Z 9	<b>(No)</b> Upper, Lower Case, Predictive Text & Numerical	<b>(5)</b> J K L 5	<b>(0)</b> 0 _		
<b>(1)</b> . , ? ! 1 @ " -	<b>(6)</b> M N O 6	<b>(↕)</b> Move Cursor																
<b>(2)</b> A B C 2	<b>(7)</b> P Q R S 7	<b>(Chime)</b> Copy Text to Memory																
<b>(3)</b> D E F 3	<b>(8)</b> T U V 8	<b>(Part)</b> Paste Text from Memory																
<b>(4)</b> G H I 4	<b>(9)</b> W X Y Z 9	<b>(No)</b> Upper, Lower Case, Predictive Text & Numerical																
<b>(5)</b> J K L 5	<b>(0)</b> 0 _																	
<b>(Yes)</b>	<b>Door Control</b> (only available to Users with Door Strike attribute)	Use <b>(1-8)</b> to select a door, <b>(0)</b> to select network <b>(Yes)</b> to accept																
		<table border="0"> <tr> <td><b>(1)</b> Door 1</td> <td><b>(4)</b> Door 4</td> <td><b>(7)</b> Door 7</td> </tr> <tr> <td><b>(2)</b> Door 2</td> <td><b>(5)</b> Door 5</td> <td><b>(8)</b> Door 8</td> </tr> <tr> <td><b>(3)</b> Door 3</td> <td><b>(6)</b> Door 6</td> <td><b>(0)</b> Select Network</td> </tr> </table>	<b>(1)</b> Door 1	<b>(4)</b> Door 4	<b>(7)</b> Door 7	<b>(2)</b> Door 2	<b>(5)</b> Door 5	<b>(8)</b> Door 8	<b>(3)</b> Door 3	<b>(6)</b> Door 6	<b>(0)</b> Select Network							
<b>(1)</b> Door 1	<b>(4)</b> Door 4	<b>(7)</b> Door 7																
<b>(2)</b> Door 2	<b>(5)</b> Door 5	<b>(8)</b> Door 8																
<b>(3)</b> Door 3	<b>(6)</b> Door 6	<b>(0)</b> Select Network																
<b>(Yes)</b>	<b>Assign Prox TAG</b>	Press <b>(Yes)</b> to assign TAG, present TAG to 'Prox' symbol on keypad																

9 <sub>wp2</sub>		Engineer Utils
0 <sub>...</sub>	View System Log	Yes to view System, Alarm or Mandatory log
1 <sub>...</sub> 2 <sub>...</sub> 3 <sub>...</sub>	System log Alarm Log Mandatory Log	Use $\updownarrow$ to move up and down through log (down moves back in time, up moves forward again), Area to show area information or time and date, 1 - 7 <sub>...</sub> or Chime to find specific events $\updownarrow$ Move backwards and forwards Area View Area/Time and date 1 View Priority Alarms 2 <sub>...</sub> View Normal Alarms 3 <sub>...</sub> View Open/Close Events 4 <sub>...</sub> View Omits/Reinstate Events 5 <sub>...</sub> View Maintenance Events 6 <sub>...</sub> View Tamper Alarms 7 <sub>...</sub> View Test Call Events Chime View Matching Events
1	Do Bell Test	Use $\updownarrow$ to select an option, use 1 - 8 <sub>...</sub> or Yes to activate outputs 1: Test Bell 2: Test Strobe 3: Test Speaker 4: Test Digi 5: Test Panel 6: Test RedCARE 7: Fast 8: LCD Display 9: User Outputs
2 <sub>...</sub>	Do Walk Test	Press Area to display zones that have been tested/still need testing, Chime to make zones Chime every time they are activated.
3 <sub>...</sub>	View Zone Status	Use 0 - 9 <sub>...</sub> to enter zone number or use $\updownarrow$ to search, Chime to walk test selected zone, Omit to omit zone temporarily
4 <sub>...</sub>	System Tests	Use 1 - 4 <sub>...</sub> to select an option or use $\updownarrow$ to search, Yes to accept 1 View Sys. Status 2 <sub>...</sub> View Batt Status 3 <sub>...</sub> Test Outputs (see Do Bell Test) 4 <sub>...</sub> View Version No.
5 <sub>...</sub>	Confirm Devices	Use $\updownarrow$ to select network, Yes to confirm Devices, Area to view error count, Reset to reset error count
6 <sub>...</sub>	Check RKP Status	Use 1 - 8 <sub>...</sub> to select keypad, 0 to select network, Area to display errors/tamper, No to test output, Omit to test sounder,
7 <sub>...</sub>	Check Exp. Status	Use 1 - 8 <sub>...</sub> to select expander, 0 to select network, Area to display zones/voltage/outputs/errors, Chime to test zones, Omit to test sounder, 1 - 8 <sub>...</sub> to test outputs
8 <sub>...</sub>	Set System Time	Use 0 - 9 <sub>...</sub> to enter time (24-hour format) H H M M, Yes to accept
9 <sub>...</sub>	Set System Date	Use 0 - 9 <sub>...</sub> to enter date D D M M Y Y, Yes to accept
$\updownarrow$	Location Text	Press Yes to view Location Text
$\updownarrow$	Print Log	Use 1 - 8 <sub>...</sub> to enter number of events to be printed, Yes to print log
$\updownarrow$	Start Soak Test	Use 1 - 8 <sub>...</sub> to select an area, (0 = all areas, Area = areas A - H and I -P), Yes to accept, Yes to start test
$\updownarrow$	Change Eng.Code	Use 0 - 9 <sub>...</sub> to enter a code, Yes to accept
$\updownarrow$	Adjust Volumes	Use $\updownarrow$ to select Panel, Keypad or Expander speakers. Press No to edit, 0 - 8 <sub>...</sub> to enter a value, Yes to accept
$\updownarrow$	Default NVM Data	Press 1 - 8 <sub>...</sub> to select an option or $\updownarrow$ to search, Yes to default 00: Panel Outputs 01: Digi Outputs 02: Expander Outputs 03: Keypad Outputs 04: Com???? Channels 05: RedCARE Pins 06: Zone Types 07: Zone Text 08: Expander Options 09: Remote Options 10: User Codes 11: System Timers 12: System Options 13: Area Options 14: System Text 15: UDL Options 16: Digi Options
$\updownarrow$	View iD Data	Use 0 to select loop, Area to select normal scan, quick scan or biscuit mapping. Use $\updownarrow$ to select biscuit, No to edit, 0 - 9 <sub>...</sub> to enter zone number, Yes to accept
$\updownarrow$	Configure Radio	Use 1 - 8 <sub>...</sub> to select a device, Yes to learn device, No to map zone, 1 - 8 <sub>...</sub> to enter zone number, Yes accept
$\updownarrow$	Ricochet Diagnostics	Use 1 - 8 <sub>...</sub> to select a device, Chime to scroll between different diagnostics screens.

Omit *	<b>Ricochet® Learn</b>
	Will go to the next available wireless zone starting at 9 or Press  to search. Learning always starts from the next available zone, deleting ways starts from the highest zone learnt to the system.
Reset	Enters the Delete Menu

\*Where available.

Part	<b>Alter Part Arms</b>		
	Press  -  to enter zone number or use  to search, ,  Of  to select Part Arms 1, 2 or 3		
Omit	Part Arm 1	Part Arm 2	Part Arm 3

## Changing the default codes

When the control panel is first powered up and the factory default settings are loaded only the Engineer code and the Master User code exist.

The Factory default Engineer User code is .

The Engineer is always User 00.

The Factory default Master User code is

.

The Master User is always User 01.

If the Master User code has been lost or forgotten, it can be reprogrammed by the Engineer in this menu.

## Changing the Default Codes

To change the default User Code proceed as follows:-

Users with access to this option can change their own User codes. User codes are unique to each user and can be 4, 5 or 6 digits long.

Before changing the codes, it is vital that you memorise or write down the new code you are about to program.

### User

- 
- Press
- Press
- Enter
- Press
- Enter a new 4, 5 or 6-digit User code
- Press to accept the new code
- Press
- Press again
- Press to exit the menu The display will return to normal

### Engineer

- 
- Press
- Press
- Enter
- Press
- Enter a new 4, 5 or 6-digit User code
- Press to accept the new code
- Press
- Press again
- Press to exit the menu The display will return to normal

## Changing the Time & Date

### Time

1. Enter the User Code ( ? ) ( ? ) ( ? ) ( ? )
2. Press ( Menu )
3. Press ( Yes )
4. Press ( 7 ) ( POS )
5. Press ( Yes )
6. Enter the new time ( ? ) ( ? ) ( ? ) ( ? )
7. Press ( Yes )
8. Press ( Menu )
9. Press ( Reset )
10. Press ( Yes ) to exit the menu The display will return to normal

### Date

1. Enter the User Code ( ? ) ( ? ) ( ? ) ( ? )
2. Press ( Menu )
3. Press ( Yes )
4. Press ( 7 ) ( POS )
5. Press ( Yes )
6. Enter the new time ( ? ) ( ? ) ( ? ) ( ? )
7. Press ( Yes )
8. Press ( Menu )
9. Press ( Reset )
10. Press ( Yes ) to exit the menu The display will return to normal

To programme any advanced features of the system, or to add codes for users, add device descriptions etc...Please refer to INS176- on the enclosed CD.

## Control Panel Features

### Premier Elite 12-W/24-W/48-W

- 4 Onboard Zones
- Max 8,16 or 32 wireless device **Ricochet** enabled receiver onboard
- Expandable to 12-48 zones via keypads and zone expanders
- 1 x 4-wire data network (standard 7/0.2 alarm cable)
- Up to 4 keypads (2 only on the 12-W) and 0-3 zone expanders
- Up to 2 output modules (0 on 12-W)
- 2 or 4 independent areas each with 3 part arms
- 2 or 4 area arm suites
- 8 (12-W), 25 (24-W), or 50 (48-W), programmable User codes
- 250 (12-W) or 500 (24-W/48-W) Event Log (time & date stamped)
- 1 or 2 programmable panel outputs (2 x 500mA )
- 1.5 Amp power supply
- 3 or 8 programmable digicom outputs (100mA each)
- 32 character zone text
- Facility for Plug-on Digimodem (Com300/2400)
- Facility for Plug-on GSM Module
- Facility for Plug-on IP Module (ComIP/Chiron/WebWayOne/Emizon) or any supported device
- PC-Com/printer port

## Control Panel Layout (Premier Elite™ 48-W Shown)

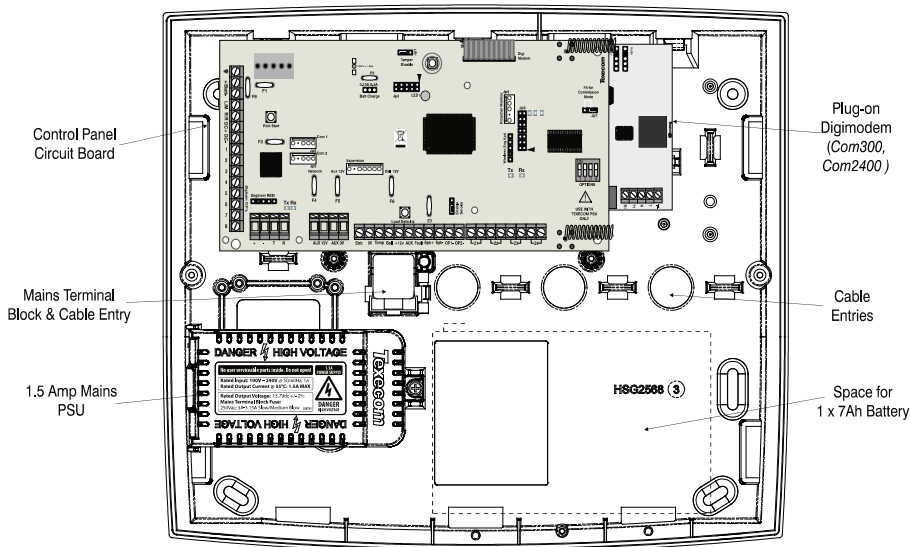

## PCB Layout (48-W Shown)

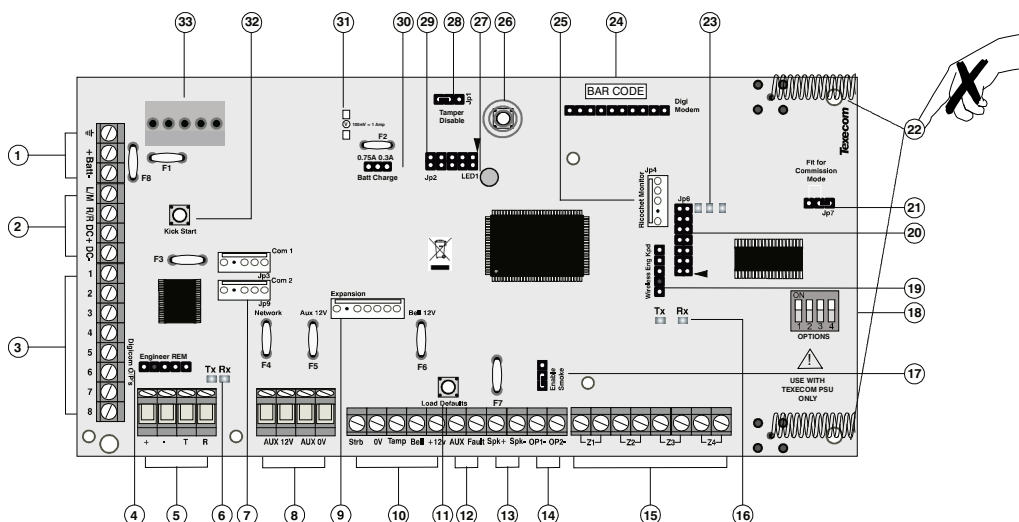

### 1: Battery Connections

A 12V rechargeable battery must be connected to these terminals in order to provide continuous system operation in the event of an AC Mains failure. (protected by 1.6 Amp PTC Fuse)

### 2: Digicom Power & Inputs (24/48-W Only)

These terminals provide un-fused power; remote reset and line fault inputs and are normally used for connecting a stand-alone communicator to the control panel.

### 3: Digicom Outputs

Outputs 1 to 8 are low current (100mA '-ve' applied) and would normally be used when connecting a stand-alone communicator to the control panel. Each output is fully programmable.



NOTE Outputs 4-8 are not fitted on the 12-W

### 4: Engineers Keypad

A portable Engineers keypad can be plugged on here to allow easier access for programming and testing.



NOTE When using a keypad as an Engineers keypad, the address must be set to '10'. The keypad zones and lid tamper are not monitored.

### 5: Network Data Connections

Network 1 provides connection for the keypads and zone expanders. The '+' and '-' terminals provide power whilst the 'T' transmits data and 'R' receives data.

### 6: Network Data Indicators

The red LED indicates that data is flowing out of the control panel and normally flashes very quickly. The green LED indicates that data is flowing into the control panel and normally flashes slowly, the green LED flashes faster as more devices are connected.

### 7: Communication Ports

Com Port 1 is a serial communications port and can be used for connecting a PC running *Wintex* or any supported serial device to the control panel.

Com Port 2 is a serial communications port and can be used for connecting a PC running *Wintex* or any supported serial device to the control panel.

### 8: Auxiliary 12V Power

These terminals are for connecting devices that require 12V power (protected by a 0.9A PTC fuse).

### 9: Expansion

The Expansion Port can be used for connecting a 60XiD Zone Expander or an AV Module.

### 10: External Sounder Connections

These terminals are used for connecting to an external sounder unit.

### 11: Load Defaults Button

Press and hold this button whilst applying power to the control panel to load the factory default settings. Press and hold this button for 7 seconds with power already on the panel to restore just the Engineer code to the factory setting of (1) (2<sub>abc</sub>) (3<sub>def</sub>) (4<sub>ghi</sub>).



**NOTE** Loading the factory defaults can take up to 60 seconds to complete.

Loading defaults will only be possible if the NVM has not been locked.

For a complete list of factory defaults, see the **Premier Quick Reference** supplied on the enclosed CD.

### **12: Auxiliary Tamper/Fault Connections**

These terminals can be used for monitoring the tamper loop of an auxiliary device.

### **13: Loudspeaker Connections**

These terminals can be used for connecting up to one 8Ω or two 16Ω loudspeakers.

### **14: Panel Outputs**

Outputs 1 & 2 are 500mA '-ve'. These outputs are all fully programmable.



**NOTE** Output 2 is not programmable on the 12-W & 24-W

### **15: Zone Connections**

4 Fully programmable zone inputs

### **16: Ricochet Network LED's**

Green LED = Data received by the expander from the panel  
Red LED = Data transmitted by the expander to the panel. *(The flash rate depends on the mode and RF activity)*

### **17: Enable 2 wire smoke (24/48-W Only)**

Panel Output 1 can be used for connecting up to 10, 12V 2-Wire smoke detectors.

### **18: Options Switch**

Use to select the receiver functionality.

Switch 1 OFF = not used on Premier Elite 24/48-W.

Switch 2 OFF = Premier Elite 24/48-W Ricochet Mode

ON = Not Used

Switch 3 ON = Impaq Contact-W Wired Input 2 will report as Tamper (default)

OFF = input 2 will report as an Alarm.

Switch 4 OFF Walk test

### **19: Ricochet Eng keypad connection**

An engineer's keypad (*Premier LCD* keypad and interface lead) can be temporarily plugged onto this connector to allow system programming and testing. Set the keypad address switches to all ON.

### **20: Ricochet Firmware Flash Port**

Connections for flasher interface to update Ricochet receiver firmware. (factory function only)

### **21: Commission Mode Jumper**

Fit when learning and placing devices, remove once complete.

### **22: Antenna**

RF antenna

### **23: RF LED's**

Left = RED Transmit, Middle = GREEN Receive, Right = RED Wireless Network Tick.

### **24: Plug-on Communicator Connections**

This socket provides connection for Premier COM300/COM2400 plug-on communicators via the lead provided.

### **25: Ricochet Comm. Port Connection (24/48-W Only)**

Serial communications port for connecting to a PC via PC Com/USB Com or Com IP for use with Ricochet Monitor Software.

### **26: Cover Tamper**

Provides tamper protection for the control panel.

### **27: Heartbeat LED/Power Light**

Flashes steadily to indicate that the control panel is functioning correctly. If the light is ON or OFF all the time, then there could be a problem.

### **28: Cover Tamper Disable**

Disables the lid tamper

### **29: Flash Programming Port**

For upgrading the panel firmware.

### **30: Battery Charge Selection(24/48-W Only)**

Select .03A or 0.75A battery charging current

### **31: Current Reading Pads**

To calculate the current draw of the control panel, measure the voltage across the two pads and multiply by 10 i.e. Reading = 34mV (x10) = 340mV = 340mA.

### **32: Battery Kick-start Button**

When powering up the panel without AC Mains present, this button must be pressed in order to connect the battery. If AC Mains is present this button does not need to be pressed.

### **33: Power Supply Connection**

Only for use with the Texecom PSU.

**DO NOT CONNECT ANY OTHER MAINS SUPPLY TO THESE TERMINALS**

### **PTC Protection Fuses**

The following fuses are provided:

**F6** PTC (0.9A) Auxiliary 12V Power fuse

**F4** PTC (0.9 A) Network 1 fuse

**F5** PTC (0.9 A) Bell/Strobe fuse

# Texecom

Texecom Limited, Bradwood Court, St. Crispin Way, Haslingden, Lancashire BB4 4PW, England.

**Technical Support:**

UK Customers Tel: 08456 300 600

(Calls charged at local rate from a BT landline. Calls from other networks may vary.)

International Customers Tel: +44 1706 233875

Email: [techsupport@texe.com](mailto:techsupport@texe.com)

© Texecom Limited 2014

**INS626**

