

# **Installation Manual**

## **Premier Elite 5Ci-W**

**INS655-6**

09-10-2020	• PCR01108 implemented
19-01-2022	• PCR01575 Implemented

# Content

- 1.0 Introduction ..... 4**
- 2.0 Tamper Detection ..... 4**
- 3.0 System Compatability ..... 4**
- 4.0 Battery Pack ..... 4**
- 5.0 PCB Layout ..... 5**
- 6.0 Learning the Sounder ..... 6**
- 7.0 LED Indications ..... 7**
- 8.0 Hold-Off Mode ..... 8**
- 9.0 Tamper Detection ..... 9**
- 10.0 Mounting the Unit ..... 9**
- 11.0 Rear Tamper ..... 10**
- 12.0 Installing The Cover ..... 10**
- 13.0 Comissioning ..... 11**
- 14.0 Technical Specification ..... 11**
- 15.0 Standards ..... 11**
- 16.0 Warranty ..... 12**

# 1.0 Introduction

The **Premier Elite 5Ci-W** sounder is an Internal warning device with **Ricochet®** mesh technology. It is now even easier to add an internal wireless sounder to your security system. As the device is self powered the only limit on the number of units you can put on a system is determined by how many free **Ricochet** enabled zones you have available.



*This unit is NOT designed for external applications.*

# 2.0 Tamper Detection

As this unit is designed for internal applications only, and may be mounted at low level and within easy reach the SAB facility has been disabled and the unit **WILL NOT** self activate in the case of the device being tampered.

# 3.0 System Compatability

The **Premier Elite 5Ci-W** is compatible with all **Premier Elite** control panels V2.11 and later, and **Premier Elite 8XP-W** & **Premier Elite 32XP-W**. **Ricochet** Monitor V2.18.2 or later should also be used.

# 4.0 Battery Pack







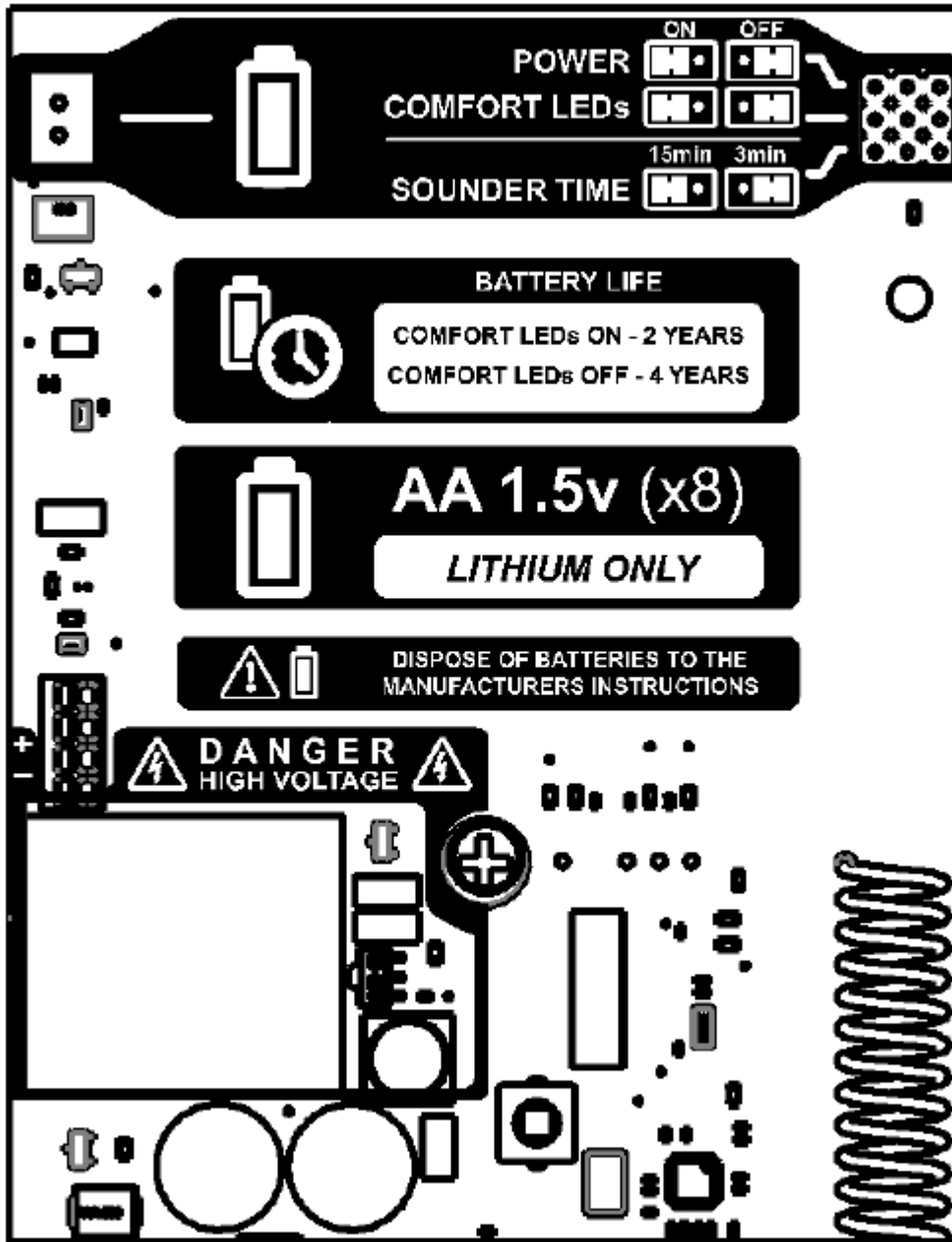

The battery pack is retained by a reusable cable tie. and should be secured through the holes in the backplate above the Piezo module.



*All eight batteries (supplied) must be installed with the correct polarity. Failure to do so will result in the device report ing a battery fault. If 1-2 batteries are incorrectly fitted the firmware will detect this on power up and flash both comfort LED's for approximately 10 minutes. While the unit is in this state it will not learn to a panel. After approximately 10 minutes the unit will power off in order to save energy.*

# 5.0 PCB Layout

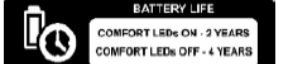

Symbol	Description
	The battery pack should be connected here after installing the batteries.
	Powering the sounder on for the first time starts the learn process. Once learned the "POWER" jumper should be left in the "ON" position.  <small> <i>If you need to relearn the sounder, the link should be moved to the OFF position for a minimum of 1 second.</i></small>
	Enables or disables the comfort LED's. Disabling the LED's significantly increases battery life.
	The sounder on time is dictated by this jumper position and is independent of the Bell On time in the control panel. If however the panel bell time is shorter than the jumper setting selected, the panel will over ride the jumper setting.
	Only Lithium AA 1.5V Type batteries should be used  <small> <i>Alkaline batteries should not be used, they will have a much shorter lifespan and can freeze and fail to operate at -5°</i></small>
	Used Batteries should be disposed of according to the manufacturers instructions.
	The quoted battery life is an estimate and will depend on the site conditions.

## 6.0 Learning the Sounder

As with all **Ricochet** enabled devices, the sounder should be learned to the control panel along with all other devices BEFORE it is installed in it's final location.

The **Premier Elite 5Ci-W** is learned to a Zone on the control panel in the same way that **Ricochet** enabled detection devices are. The Zone type and **Ricochet** Device Mode is automatically assigned based on the type of device being learned. In the case of the sounder the Zone Type is set to "Custom" and the **Ricochet** Device Mode is set to Device Specific. These should not be changed. Zone attributes 1 & 2 and Chime options will be ignored for **Ricochet** enabled Sounders.

- You can learn the device from first power up following "**Confirm Devices**" or from the dedicated **Ricochet** Learn menu.
- The 5Ci-W has no Learn Switch, learning is initiated by connecting the batteries via the Power Jumper
- To learn the 5Ci-W to the system follow the diagram below.

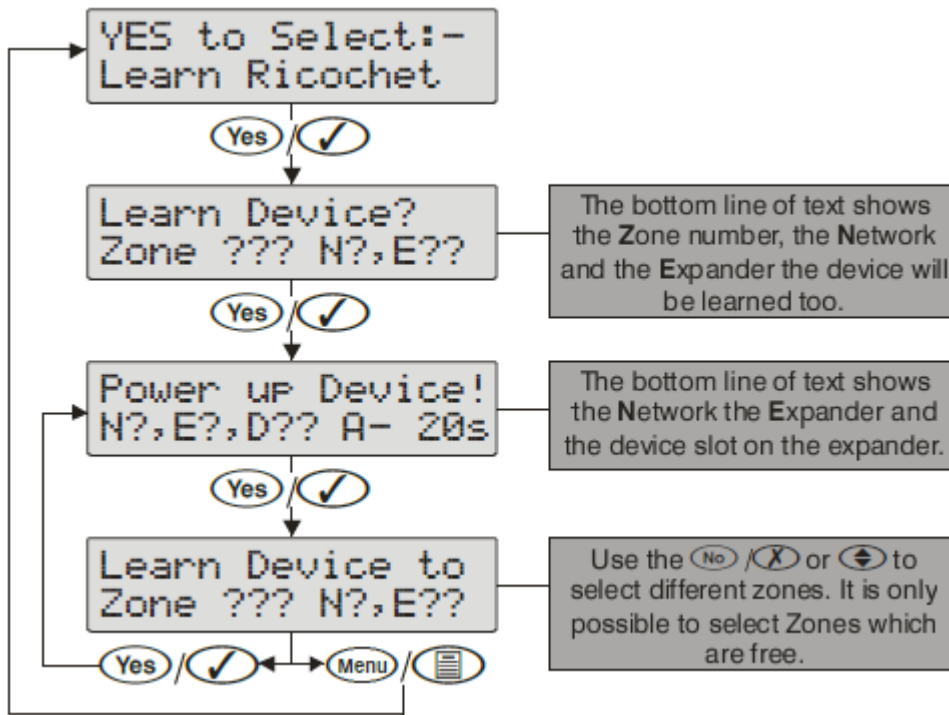

**NOTE** If you need to delete the device from the system you should first put it into "hold off " mode and remove the batteries.

**NOTE** If the device will not learn to the system check that all batteries are installed correctly.

## 7.0 LED Indications

The **Premier Elite 5Ci-W** LED's aid in the installation of the device and act as status indicators. The table below details the status of each LED indicator.

**NOTE** The LED jumper has no effect on the status described below.

Leds	Status
Left LED flashing quickly	Device is attempting to communicate with receiver after power up.
Left LED flashing slowly	Device has learnt or re-connected to receiver and is waiting for the tamper to be closed.
Both LEDs off	Device has failed to learn or failed to communicate after tamper has been closed.
Right LED flashing quickly	Device is attempting to communicate with receiver after tamper has been closed.
Right LED on solid (for 3 seconds)	Device has successfully connected with receiver after tamper closed.
Right LED flashing slowly	Hold-off mode has been requested from the panel but the tamper is closed. Bell will not self-activate. Cancels after 20 minutes.
LEDs alternating quickly.	Device has successfully connected with receiver after tamper closed and self-activation on tamper will re-activate in 2 minutes.
Both LEDs flashing	1 or 2 batteries are fitted incorrectly. Remove the batteries and reinstall correctly.

## 8.0 Hold-Off Mode

For safety reasons, each Texecom sounder and strobe unit incorporates a unique patented engineer Hold-Off mode. This mode prevents the unit from self-activating during installation and maintenance, thereby allowing only bona fide engineers access to the unit without any loss of tamper protection. The sounder can be put in hold-off mode by flashing the strobe 3 times, or by pressing the Omit key when in Bell Test menu.

When the outer cover is replaced and the tamper circuit is closed, the LEDs will alternate rapidly, confirming that the tamper circuit is secure and signalling that self activation on tamper will be re-enabled within 2 minutes, after which the LEDs will alternate slowly to signal normal operation. If the tamper circuit is re-opened within the 2 minute period, then hold-off mode will be restored.



*The LED's will only flash after hold off mode has stopped IF the LED jumper is in the "ON" position.*



*The strobe is disabled during hold-off mode. Hold-off mode is immediately cancelled when the sounder is activated from the control panel if the tamper is closed.*



## 9.0 Tamper Detection

As this unit is designed for internal applications only and may be mounted at low level and within easy reach the SAB facility has been disabled. The unit **WILL NOT** self activate in the case of the device being tampered.

**Care should be taken when installing these devices, and all possible precautions should be taken to ensure the units are not easily accessible to unauthorised persons.**

Tamper signals will still be generated and logged by the control panel. Tamper signals will also be transmitted to the ARC if signalling is enabled.

## 10.0 Mounting the Unit

Select a suitable position to mount the unit, which satisfies the following criteria:

- Good wireless signal



*The wireless signal may be checked before final installation by depressing the tamper switch briefly. The Right LED will flash to indicate communication and will go solid for 3 seconds to indicate a successful connection.*

- Highly prominent for maximum deterrence
- High enough to be out of normal reach to deter tampering. See above

In addition to the corner screw fixing points, the unit also has a central keyhole to simplify mounting and aid levelling.

Four screws and wall plugs are required for mounting the backplate to an even surface.



*An additional screw is required to provide "Removal from Mounting" tamper and is required in installations complying with the requirements PD6662 and/or EN50131. In doing so, care must be taken to leave the screw head slightly proud to ensure that the microswitch remains level and closes correctly when the outer cover is fitted.*

## 11.0 Rear Tamper

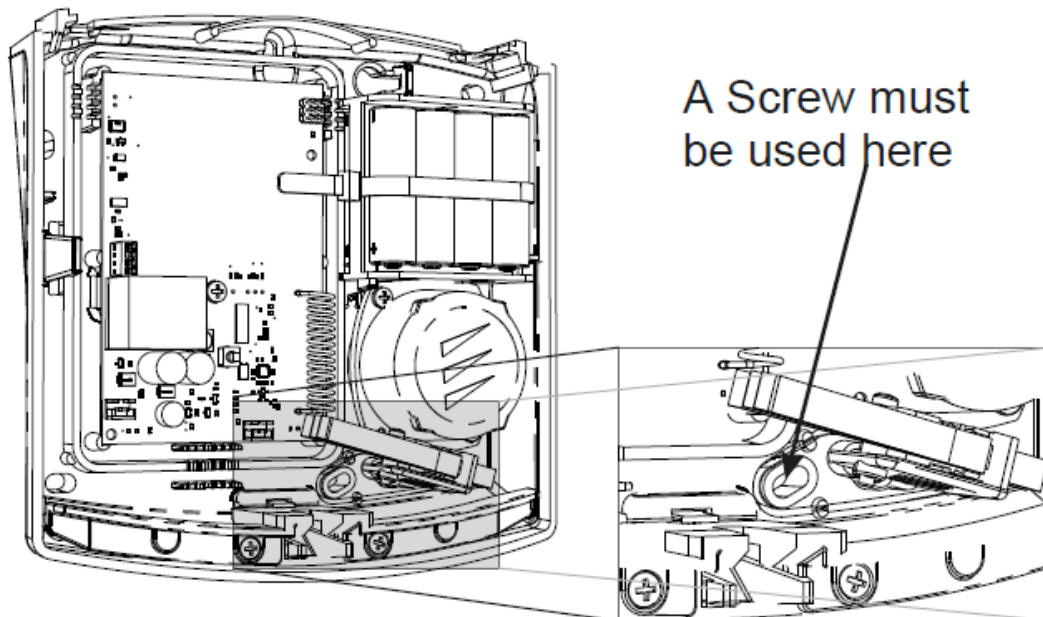

## 12.0 Installing The Cover

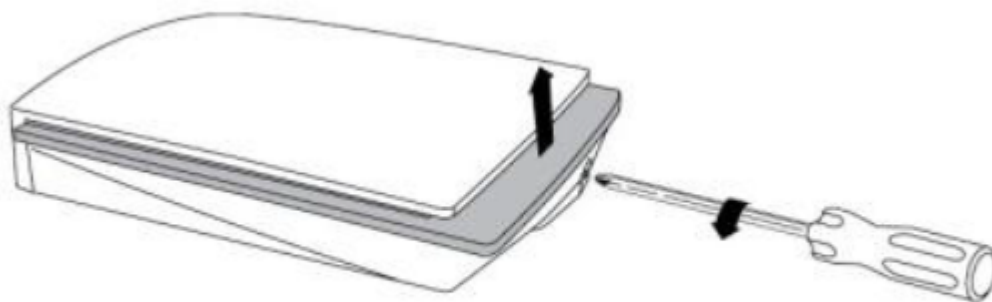

Screw retained in lid.

## 13.0 Comissioning

Once the installation is complete the sounder should be tested to confirm correct operation. This can be achieved by utilising the Bell/Strobe test facility in the "Engineer Utilities" menu.

## 14.0 Technical Specification

Electrical Specification	
Supply Voltage	11-15Vdc
Sounder Current Max	85mA
Strobe Current Max	15mA
Combined Sounder and Strobe Max	100mA
Low Voltage Value	11.1V @ 25°C
Quiescent Current	17µA @ 30°C

## 15.0 Standards



Texcom declares that this product complies with the requirements of the following directives:

- 2014/30/EU - EMC Directive
- 2014/35/EU - LV Directive
- 2014/53/EU - RE Directive
- 2011/65/EU - ROHS Directive

The product therefore meets all the requirements to enable it to be CE marked.

Weee Directive: 2012/19/EU (WEEE directive): Products marked with this symbol cannot be disposed of as unsorted municipal waste in the European Union. For proper recycling,

return this product to your local supplier upon the purchase of equivalent new equipment, or dispose of it at designated collection points. For more information see: [www.recyclethis.info](http://www.recyclethis.info).

This product is a Type B Moveable device and is suitable for use in systems designed to comply with EN 50131-4, EN50131-5-3 and PD6662 at Grade 2 and Environmental Class II.

Certified by KIWA (Telefication) B.V.

**Security Grade 2 Environmental Class 2**

EN Standard	Premier Elite 5Ci-W
EN60950-1	✓
EN61000-6-3	✓
EN 301 489-3	✓
EN50130-4	✓
EN300 220-1	✓
EN50131-1	✓
EN50130-5	✓
EN50131-5-3	✓
EN50131-6	✓
PD6662	✓
EN50131-4	✓

## 16.0 Warranty

All Texecom products are designed for reliable, trouble-free operation. Quality is carefully monitored by extensive computerised testing. As a result the *Premier Elite 5Ci-W* is covered by a two year warranty against defects in material or workmanship (details on request).

Because the *Premier Elite 5Ci-W* is not a complete alarm systems but only a part thereof, Texecom cannot accept responsibility or liability for any damages whatsoever based on a claim that a unit failed to function correctly. Due to our policy of continuous improvement Texecom reserve the right to change specification without prior notice.

*Premier* & *Premier Elite* are trademarks of Texecom Ltd