

## DS-D5C75RB/B 75-inch Interactive Flat Panel

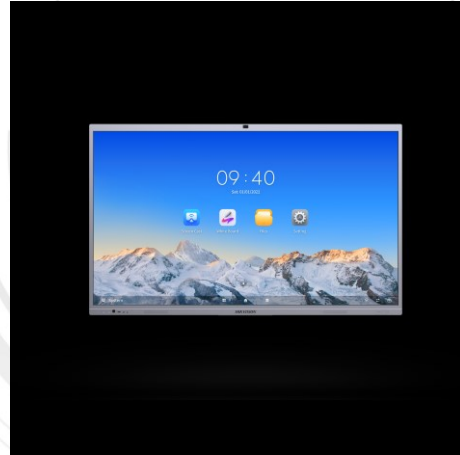

The Hikvision Interactive Flat Panel is a kind of newly developed intelligent teaching assistance product which integrates with the latest technologies of touch control, HD display, video processing, network communication, interactive control, sound control. It can be widely applied to the classroom, online teaching, training center, etc.

- UHD 4K display with resolution of 3840 × 2160.
- Anti-glare and anti-blocking design to ensure smooth interaction.
- Dual systems of Android and Windows (Optional with OPS) saving cost and easy to use, video conference software are recommended to run under Windows system.
- Quick response, at most 50-points touch control and smooth writing experience.
- Built-in network switch chip saves a network switch.
- All-in-one design with tempered glass and intelligent temperature control, making it environmental-friendly and safety-guaranteed, support blue light protection.
- EDLA Certified

## ▪ Specification

Product Model	
Product Model	DS-D5C75RB/B
Display	
Screen Size	75 inch
Backlight	DLED
Pixel Pitch	0.14325(H) × 0.42975(V) mm
Resolution	3840 × 2160 @60 Hz
Brightness	400 cd/m <sup>2</sup> (Typ.)
Color Depth	10 bit
Display Color	1.07 G
Response Time	5 ms
Panel Type	VA
Contrast Ratio	5000:1 (Static) 30,000:1 (Dynamic)
Color Gamut	72% NTSC (CIE1931) (Typ.)
Refresh Rate	60 Hz
Viewing Angle	178° (H)/178° (V)
Aspect Ratio	16:9
Surface Hardness	9H (Pencil) 7 (Mohs)
Surface Glass	Anti-Glare Glass
Surface Haze	25% Haze
Glass Bonding Method	Zero Lamination
Display Area	1650.24mm x 928.26mm
Working Duration	7 × 16 H
Transmittance	88% ± 3
Lifespan	50,000 hours
Touch	
Type	Infrared Touch Screen
Touch Point	Up to 50-point multi-touch
Touch Response Time	≤ 2 ms
Minimum Touch Object	≥ 1.5 mm (≥ 90% touching area)
Touch Precision	± 0.5 mm (≥ 90% touching area)
Touch Resolution	32767 × 32767
Built-in System	
Operation System	Android 13.0
Memory	8 GB
Built-in Storage	128 GB
Processor	Quad-core Cortex-A76 × 4 (2.4 GHz) and quad-core Cortex-A55 × 4 (1.8 GHz)
GPU	Mali-G610 MC4
HDCP Version	2.3
Camera	
Pixel	Pixel 48MP for Photos & 8 MP for Video
Camera Function	Support intelligent switching between Android system, OPS, and PC.

Field Angle	120°(diagonal), 110°(horizontal), 75°(vertical)
Distortion	≤2.5%
Camera Resolution Ratio	Up to 4K
<b>Microphone</b>	
Specification	Omni-directional 8-array layout
Mic Function	Echo reduction and smart noise-cancellation
Voice Distance	12 m
Sampling Rate	32 K
Mic Depth	16 bit
<b>Internal Function</b>	
Loudspeaker	Built-in 2 × 20 W+25W loudspeaker;
Bluetooth	Built-in BLE (Bluetooth Low Energy) module supports Bluetooth 5.1
NFC	Support screen mirroring by Android phones
Light Sensor	Yes
Image Processing Technology	Support 3D digital noise reduction, face detection, automatic white balance, automatic purple edge removal, automatic defogging; support shadow correction .
Audio Processing Technology	Support dereverberation, adaptive noise reduction, adaptive non-stationary noise reduction, adaptive echo cancellation, automatic gain control, automatic electrical level control, sound source localization, speech dynamic detection, digital beam forming, speech detection.
<b>Interface</b>	
Video & Audio Input	HDMI In (HDMI 2.0) × 3, VGA In × 1, DP In (DP 1.2) × 1, Audio In × 1
Video & audio output	HDMI Out (HDMI 2.0) × 1, Audio Out × 1, SPDIF Out × 1
Control interface	TOUCH-USB 3.0 × 3, RS232 × 1
Network Interface	LAN (1000 Mbps) × 2 WIFI AP & Station, 2.4G/5G WIFI 6, IEEE 802.11 a/b/g/n/ac/ax 2 × 2 MIMO (2.4 GHz and 5 GHz) authentication protocols WEP, WPA, WPA2, PSK and 802.1X EAP
Data Transmission Interface	USB 3.0 × 4, USB 2.0 × 1, Type-C × 2 (Type-C supports USB 2.0, DP 1.2, and charging functions; side charging 15 W, front charging 65 W)
<b>Power</b>	
Power Supply	100 to 240 VAC, 50/60 Hz
Standby Consumption	≤ 0.5 W
Average Consumption	< 150W
<b>General</b>	
VESA	800 mm × 400 mm (4 × M8-25 mm)
Product dimensions	1713.2 mm × 1034.5 mm × 82.5 mm
Accessory	Wall mount bracket, hook, user manual, touch writing pen, packing list, 3 M touch USB cable, 3.5M HDMI cable (2.0), power cable , bluetooth remote control.
Package Dimensions (W × H × D)	1937 mm × 264 mm × 1222 mm
Net Weight	51.23 kg
Gross Weight	67.62 kg
<b>Working Environment</b>	
Working Temperature	0 °C to 40 °C (32 °F to 104°F)
Working Humidity	10%~90% RH

## ▪ Physical Interface

Interface	Description	Interface	Description
1.SPDI F	SPDIF interface	2.Line OUT	Audio output interface
3.Line IN	Audio input interface	4.VGA IN	Video devices connection interface
5.TYPE-C	Type-C interface	6.DP IN	Display input interface
7.TOUCH-USB 2	Peripheral touch interface	8.HDMI IN 2	HDMI 2 input interface
9.TOUCH-USB	Peripheral touch interface	10.HDMI IN 1	HDMI 1 input interface
11.USB	USB interface	12.MULTI-USB 2	Multi-functional USB interface
13.MULTI-USB 1	Multi-functional USB interface	14.HDMI OUT	HDMI output interface

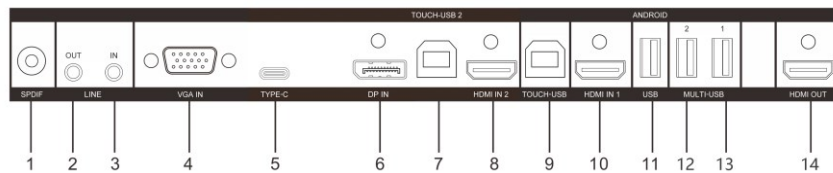

## ▪ Installation

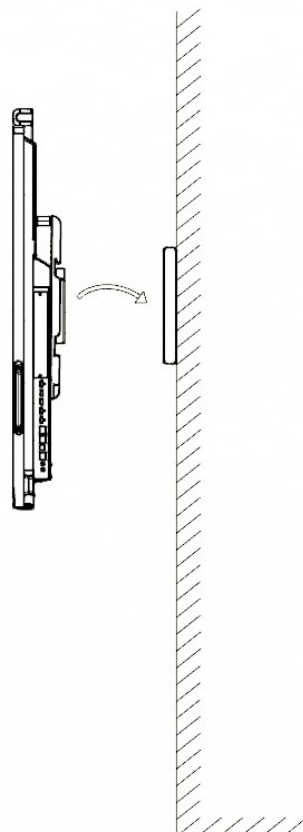

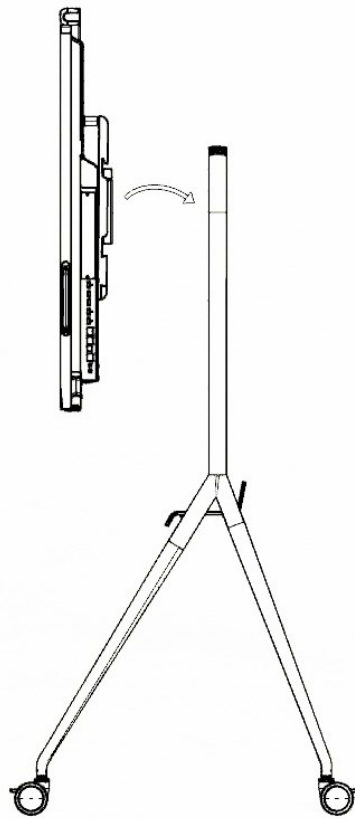

▪ **Available Model**

DS-D5C75RB/B

DS-D5C75RB/B(EDLA)

▪ **Dimension**

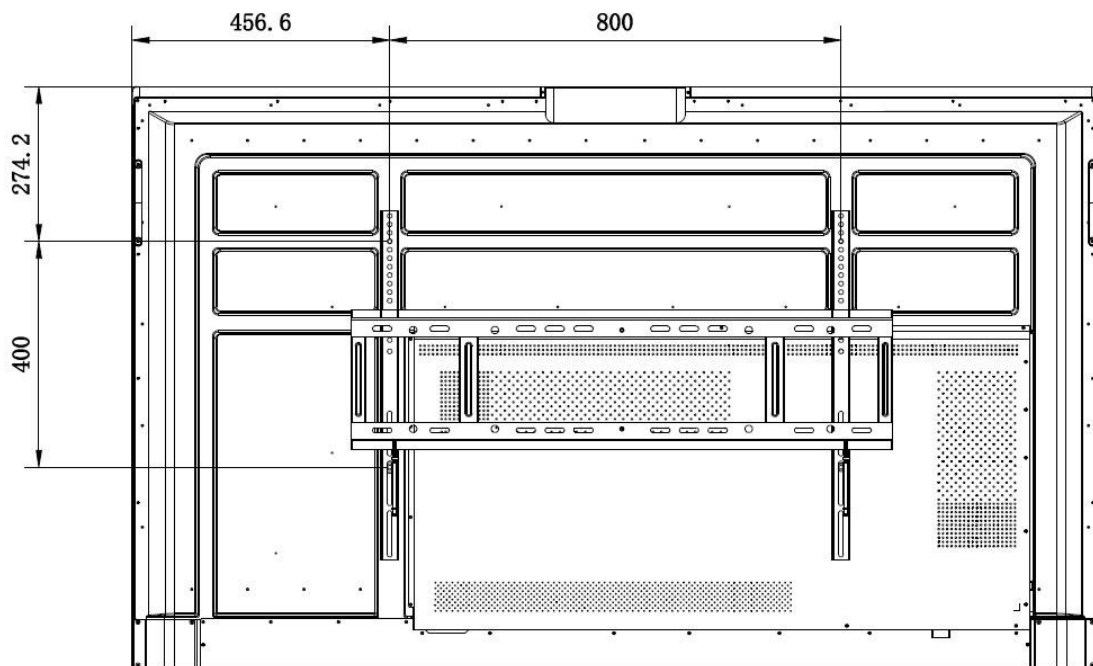

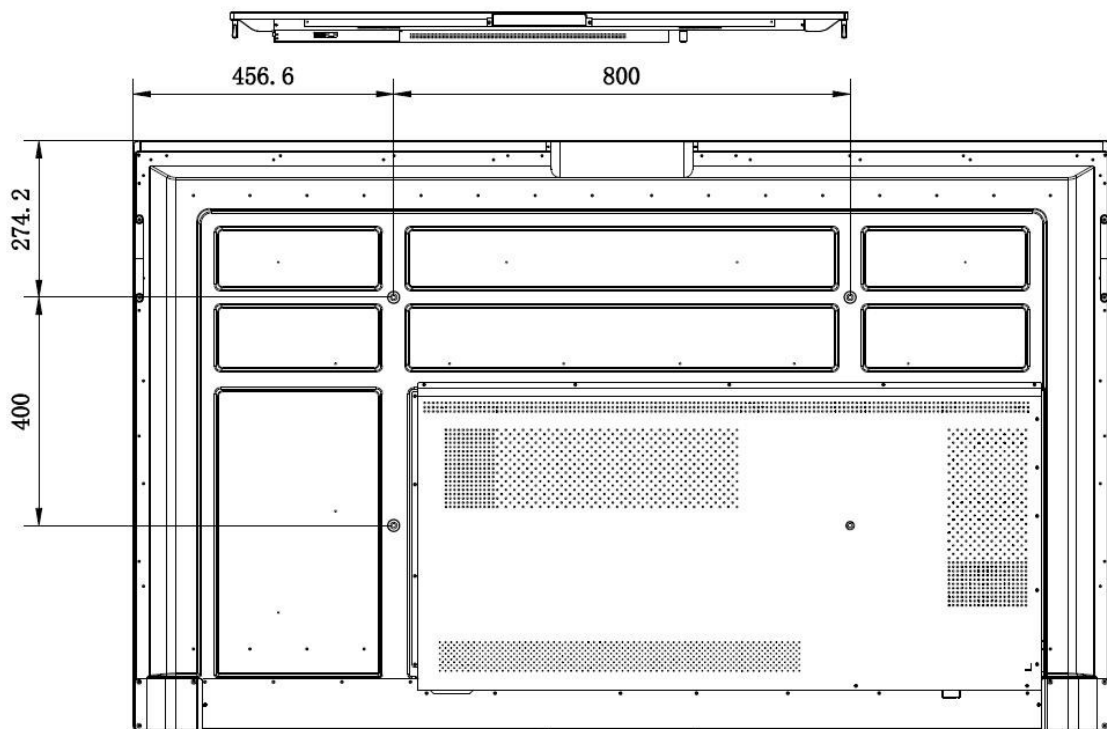
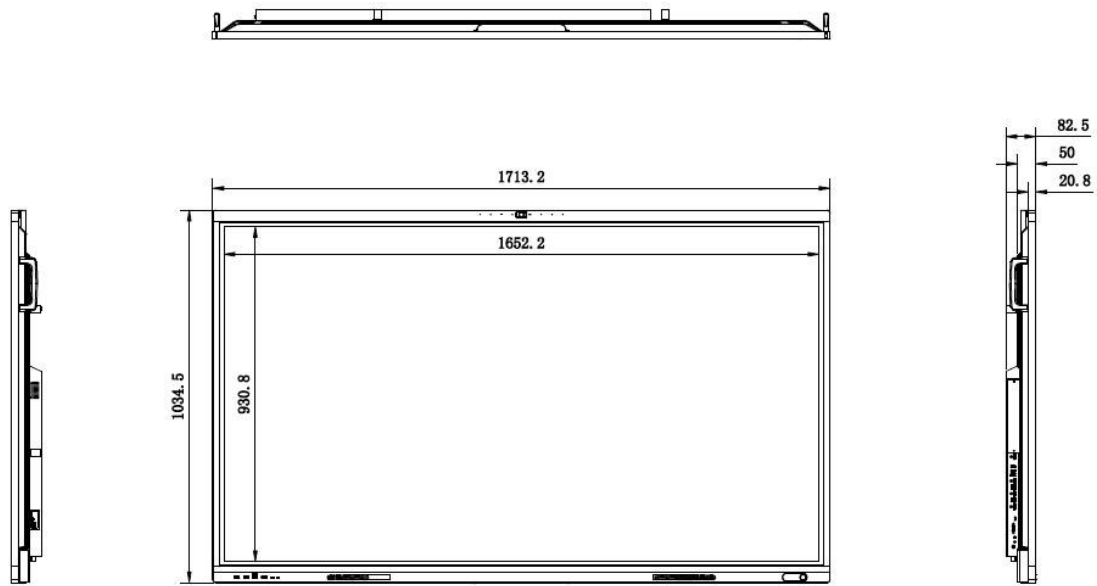

▪ Accessory

▪ Optional

<b>DS-D5ABKY2-M 75-86" Conference Flat Panel Brackets</b>	<b>DS-D5AC12T5-8S2 OPS Module</b>	<b>DS-D5AC12T7-16S5 OPS Module</b>
		