

# CombiProtect S Jeweller user manual

Updated June 26, 2024



**CombiProtect S Jeweller** is a wireless device that combines motion and glass break detectors. Detects movement at a distance of up to 12 meters, as well as a glass break with the distance up to 9 meters. Does not react to pets when installed and configured correctly.

**CombiProtect S** operates within the Ajax system, connected to a [hub](#) via the protected [Jeweller](#) protocol. The communication range in an open space is up to 1,200 meters. CombiProtect S operates for up to 5 years from a pre-installed battery. The device is designed for indoor use only.



This product line is developed for projects. Only accredited Ajax Systems partners can sell, install and administer **Superior** products.

**Superior**, **Fibra**, and **Baseline** product lines are mutually compatible. This opens up numerous possibilities for building systems of any configuration.

## Functional elements

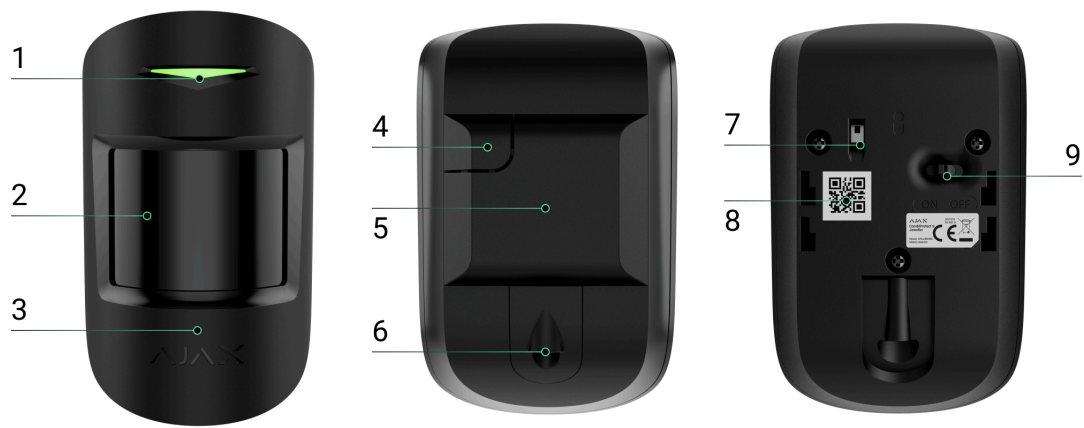

1. LED indicator.
2. Motion detector lens.
3. Microphone hole.
4. A perforated part is required for actuating the tamper in case of any attempt to dismantle the detector.
5. SmartBracket mounting panel.
6. Holding screw.
7. Tamper button.
8. QR code.
9. Device switch.

## Compatible hubs and range extenders

An Ajax hub with the firmware OS Malevich 2.16 and higher is required for the detector to operate.

Hubs	Radio signal range extenders
<ul style="list-style-type: none"> <li>• <u>Hub Plus</u></li> <li>• <u>Hub 2 (2G)</u></li> <li>• <u>Hub 2 (4G)</u></li> </ul>	<ul style="list-style-type: none"> <li>• <u>ReX</u></li> <li>• <u>ReX 2</u></li> </ul>

- [Hub 2 Plus](#)
- [Hub Hybrid \(2G\)](#)
- [Hub Hybrid \(4G\)](#)

## Operating principle

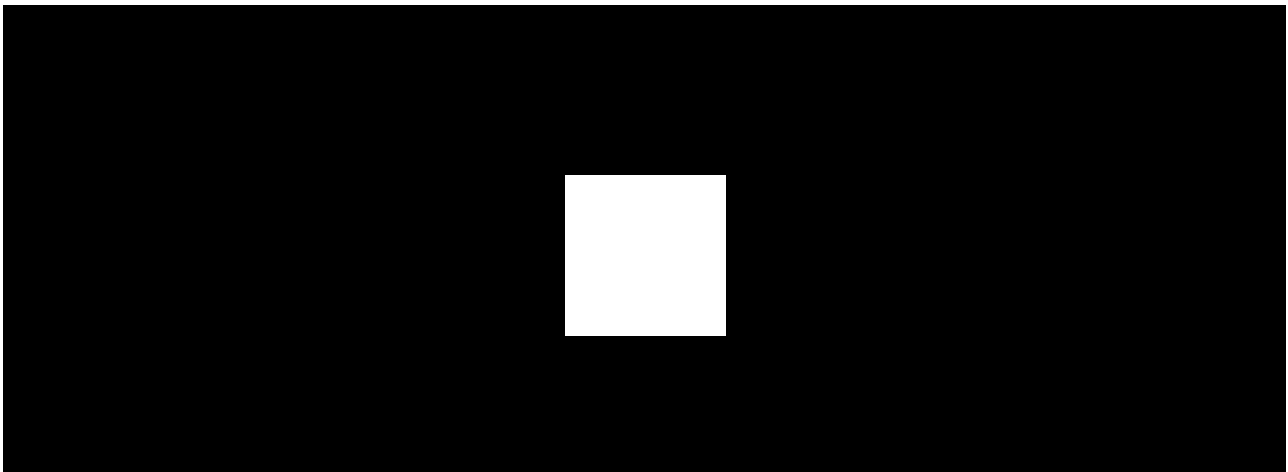

00:00

00:12

CombiProtect S combines two devices – a motion and a glass break detector.

PIR sensor detects intrusion into a protected room by detecting moving objects with a temperature close to the temperature of the human body. However, the detector can ignore pets when installed and configured correctly.

The detector uses DualTone – a two-stage algorithm to exclude false alarms. For the detector to register a break, it must record a dull (low-frequency) sound of an impact and a ringing (high-frequency) sound of falling fragments within 1.5 seconds. This algorithm ensures that the detector does not respond to the barking of dogs or cars passing the protected facility.



If any film, such as shockproof, sunscreen, decorative, or other, covers the glass, CombiProtect S does not detect glass breaking. To detect the breaking of this type of glass, we recommend using a DoorProtect S Plus.

After actuation, the armed detector immediately transmits an alarm signal to the hub, activating the sirens and notifying the user and security company.

If, before arming the system, the detector has detected motion, it will not arm immediately but during the next inquiry by the hub.

## Jeweller data transfer protocols

Jeweller is a two-way wireless data transfer protocol that provides fast and reliable communication between hub and devices. The detector uses a Jeweller to transmit alarms and events.

[Learn more](#)

## Pet immunity

When properly installed and configured, CombiProtect S Jeweller does not react to pets weighing up to 20 kg and below 50 cm in height. To [install](#) and [configure](#) the detector, follow our recommendations.

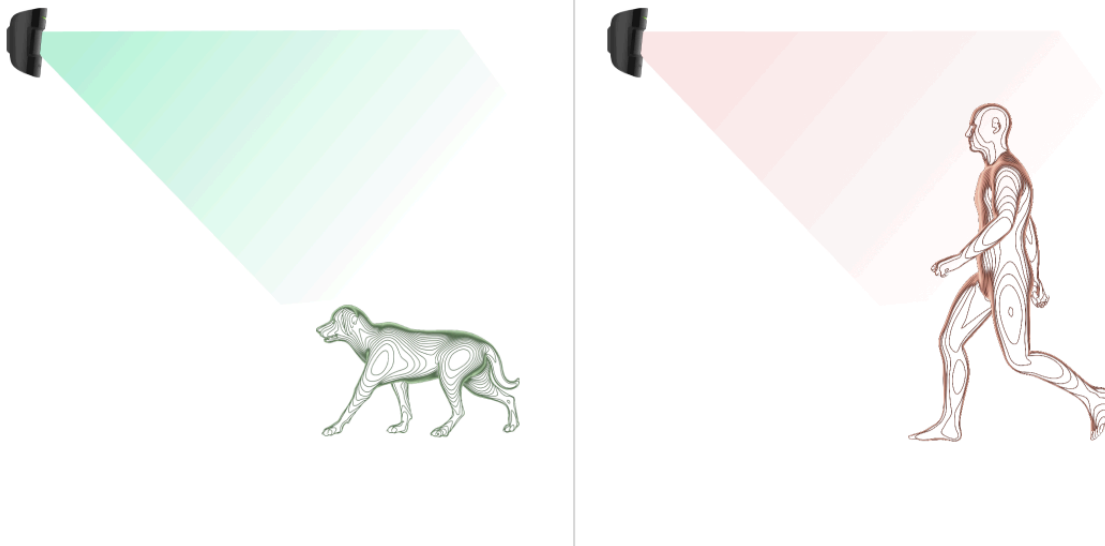

[Why motion detectors react to animals and how to avoid it](#)

[How to install the detector correctly](#)

## Temperature compensation

Temperature compensation is necessary for the detector's response to movements, even if the room temperature is close to the human body temperature. Read more about temperature compensation in [this article](#).

## Sending events to the monitoring station

The Ajax system can transmit alarms to the [PRO Desktop](#) monitoring app as well as the central monitoring station (CMS) in the formats of **SurGard (Contact ID)**, **SIA (DC-09)**, **ADEMCO 685**, and [other protocols](#).

### CombiProtect S can transmit the following events:

1. Motion alarm.
2. Tamper alarm. Tamper recovery.
3. Loss of connection with the hub. Restoration of connection.
4. Permanent deactivation/activation of the detector.
5. One-time deactivation/activation of the detector.
6. The unsuccessful attempt to arm the security system (when [System Integrity Check](#) is enabled).

When an alarm is received, the operator of the security company monitoring station knows what happened and where to send the fast response team. The addressability of Ajax devices allows sending events to the PRO Desktop or the CMS, the type of the device, its name, security group, and virtual room. The list of transmitted parameters may differ depending on the type of CMS and the selected communication protocol.

## Adding to the system



**CombiProtect S** is incompatible with [Hub](#), third-party security control panels, and ocBridge Plus and uartBridge integration modules.

To connect **CombiProtect S Jeweller** to the hub, the detector must be located at the same secured facility as the system (within the range of the hub radio

network). For the detector to work via [ReX](#) or [ReX 2](#) radio signal range extender, you must first add the detector to the hub, then connect it to **ReX** or **ReX 2** in the settings of the range extender.



The hub and the device operating at different radio frequencies are incompatible. The radio-frequency range of the device may vary by region. We recommend purchasing and using Ajax devices in the same region. You can check the range of operating radio frequencies with the [technical support service](#).

## Before adding a device

1. Install an [Ajax PRO app](#).
2. Log in to a [PRO account](#) or create a new one.
3. Select a space or create a new one.

### [What is a space](#)

### [How to create a space](#)



The **space** functionality is available for apps of such versions or later:

- Ajax Security System 3.0 for iOS;
- Ajax Security System 3.0 for Android;
- Ajax PRO: Tool for Engineers 2.0 for iOS;
- Ajax PRO: Tool for Engineers 2.0 for Android;
- Ajax PRO Desktop 4.0 for macOS;
- Ajax PRO Desktop 4.0 for Windows.

4. Add at least one virtual room.
5. Add a [compatible hub](#) to the space. Ensure the hub is switched on and has internet access via Ethernet, Wi-Fi, and/or mobile network.

6. Ensure the space is disarmed, and the hub is not starting an update by checking statuses in the Ajax app.



This product line is developed for projects. Only accredited Ajax Systems partners can install and administer Superior products.

## Connecting to the hub

1. Open the Ajax PRO app. Select the hub where you want to add the detector.
2. Go to the **Devices**  tab and click **Add Device**.
3. Name the detector, scan, or type in the QR code (placed on the detector and the package box), and select a room and a group (if Group mode is enabled).



4. Press **Add**.

5. Switch on the device by holding the power button for 3 seconds.





**CombiProtect S** works with one hub. When connected to a new hub, the detector stops sending events to the old one. When added to a new hub, the detector is not removed from the device list of the old hub. This must be done through the Ajax app.

If the connection fails, turn the detector off and try again in 5 seconds. Note that if the maximum number of devices has already been added to the hub (depending on the hub model), you will be notified when you try to add a new one.

The detector connected to the hub will appear in the list of hub devices in the Ajax app. Updating the statuses of devices in the list depends on the **Jeweller** settings. The default value is 36 seconds.

## Malfunctions

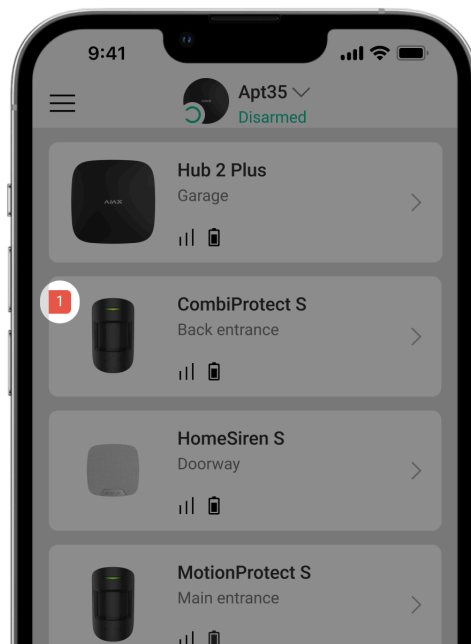

When a malfunction is detected, the Ajax app displays a malfunction counter on the device icon. All malfunctions are shown in the detector states. Fields with malfunctions will be highlighted in red.

### **A malfunction is displayed if:**

- The detector temperature is outside acceptable limits.
- The detector enclosure is open (tamper is triggered).





- No connection with the hub or radio signal range extender via Jeweller.
- The detector battery is low.

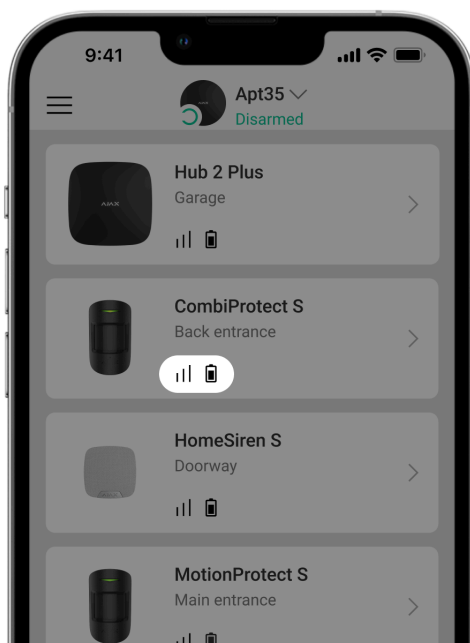









## Icons





The icons display some **CombiProtect S Jeweller** states. To access them:

1. Sign in to the [Ajax app](#).
2. Select the hub.
3. Go to the **Devices**  tab.

Icon	Meaning
	Jeweller signal strength. Displays the signal strength between the hub and the detector. The recommended value is 2–3 bars.  <a href="#">Learn more</a>
	The detector battery charge level is OK, or it is charging.  <a href="#">Learn more</a>

	<p>The detector has a malfunction. The list of malfunctions is available in the detector states.</p> <p><a href="#"><u>Learn more</u></a></p>
	<p>Displayed when the detector is operating via a <a href="#"><u>radio signal range extender</u></a>.</p>
	<p>The detector operates in the <b>Always Active</b> mode.</p> <p><a href="#"><u>Learn more</u></a></p>
	<p><b>Delay When Entering</b> and/or <b>Delay When Leaving</b> enabled.</p> <p><a href="#"><u>Learn more</u></a></p>
	<p>CombiProtect S will be armed when <b>Night Mode</b> is enabled.</p> <p><a href="#"><u>Learn more</u></a></p>
	<p>CombiProtect S has detected motion. The icon is displayed when the detector is armed.</p>
	<p>CombiProtect S has detected glass break. The detector detects glass break in the armed mode only.</p>
	<p>CombiProtect S is permanently deactivated.</p> <p><a href="#"><u>Learn more</u></a></p>
	<p>CombiProtect S has been deactivated due to exceeding the preset number of alarms.</p> <p><a href="#"><u>Learn more</u></a></p>
	<p>CombiProtect S has tamper alarms permanently deactivated.</p> <p><a href="#"><u>Learn more</u></a></p>
	<p>CombiProtect S is deactivated until the first event of disarming the system.</p> <p><a href="#"><u>Learn more</u></a></p>

	<p>CombiProtect S has tamper alarms deactivated. Until the first event of disarming the system.</p> <p><b><u>Learn more</u></b></p>
	<p>The device was not transferred to the new hub.</p> <p><b><u>Learn more</u></b></p>

## States

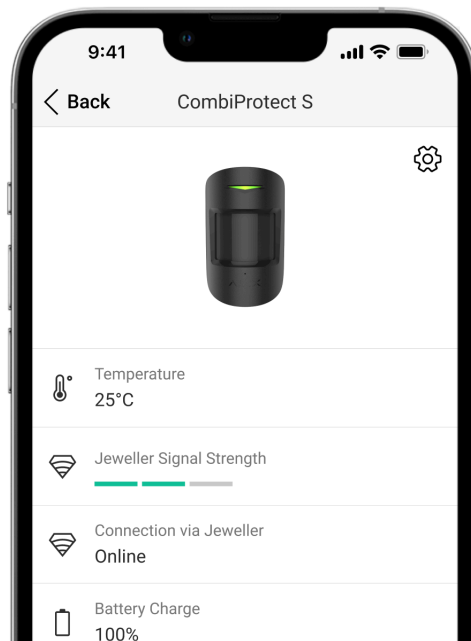

The **States** include information about the device and its operating parameters. The states of **CombiProtect S Jeweller** can be found in Ajax apps:

1. Go to the **Devices**  tab.
2. Select **CombiProtect S** from the list.

Parameter	Value
Malfunction	Clicking on  opens the list of the detector's malfunctions.

	<p>The field is displayed only if a malfunction is detected.</p>
Temperature	<p>Detector temperature. Acceptable error between the value in the app and the room temperature – 2 °C.</p> <p>The value is updated as soon as the detector identifies a temperature change of at least 1 °C.</p> <p>You can configure a scenario by temperature to control automation devices.</p> <p><a href="#">Learn more</a></p>
Jeweller Signal Strength	<p>Signal strength between the hub/range extender and the motion detector.</p> <p>We recommend installing the detector in places where the signal strength is 2–3 bars.</p>
Connection via Jeweller	<p>Connection status between the hub/range extender and the detector:</p> <ul style="list-style-type: none"> <li>• <b>Online</b> – the detector is connected with the hub/range extender.</li> <li>• <b>Offline</b> – the detector has lost connection with the hub/range extender.</li> </ul>
ReX	<p>Displays the status of using a <a href="#">radio signal range extender</a></p>
Battery Charge	<p>Battery level of the device. Displayed as a percentage.</p> <p><a href="#">How battery charge is displayed in Ajax apps</a></p>
Lid	<p>Tamper is triggered if someone tries to detach the device from the surface or damage the enclosure. There are two tamper states:</p> <ul style="list-style-type: none"> <li>• <b>Open</b> – the detector was removed from the SmartBracket, or its integrity was compromised. Check the device.</li> </ul>

	<ul style="list-style-type: none"> <li>• <b>Closed</b> – the detector is installed on the SmartBracket mounting panel. The integrity of the device enclosure and the mounting panel is not compromised. Normal state.</li> </ul> <p><a href="#"><u>Learn more</u></a></p>
Motion Detector Sensitivity	Sensitivity level of the motion detector.
Motion Detector Always Active	If active, the motion detector is always in the armed mode.
Glass Break Detector Sensitivity	Sensitivity level of the glass break detector.
Glass Break Detector Always Active	If active, the glass break detector is always in the armed mode.
Permanent Deactivation	<p>Shows the status of the device permanent deactivation setting:</p> <ul style="list-style-type: none"> <li>• <b>No</b> – the device operates in the normal mode.</li> <li>• <b>Lid only</b> – the hub administrator has disabled notifications about triggering of the device tamper.</li> <li>• <b>Entirely</b> – the detector is entirely excluded from the operation of the system. The device does not execute system commands and does not report alarms or other events.</li> <li>• <b>By number of alarms</b> – the device is automatically disabled when the preset number of alarms is exceeded (specified in the <a href="#"><u>Devices Auto Deactivation</u></a> settings).</li> </ul> <p><a href="#"><u>Learn more</u></a></p>
One-Time Deactivation	<p>Shows the status of the device one-time deactivation setting:</p> <ul style="list-style-type: none"> <li>• <b>No</b> – the device operates in the normal mode.</li> <li>• <b>Lid only</b> – notifications on the tamper triggering are disabled until the first disarm.</li> </ul>

- **Entirely** – the detector is entirely excluded from the operation of the system until the first disarm. The device does not execute system commands and does not report alarms or other events.

[Learn more](#)

### Alarm Reaction

Operating Mode

Shows how the detector reacts to alarms:

- **Instant Alarm** – the armed detector immediately reacts to a threat and raises the alarm.
- **Entry/Exit** – when a delay is set, the armed device starts the countdown and doesn't raise the alarm even if triggered until the countdown ends.
- **Follower** – the detector inherits the delays from Entry/Exit detectors. However, when the Follower is triggered individually, it immediately raises the alarm.

Delay When Entering, sec

Delay time when entering: from 5 to 120 seconds.

Delay when entering (alarm activation delay) is the time the user has to disarm the security system after entering the secured area.

**Delays work only with the motion sensor.**

[Learn more](#)

Delay When Leaving, sec

Delay time when leaving: from 5 to 120 seconds.

Delay when leaving is the time the user has to leave the secured area after the security system arming.

**Delays work only with the motion sensor.**



[Learn more](#)

Arm in Night Mode	When this option is enabled, the detector will enter the armed mode when the system is set to <b>Night Mode</b> .
Night Mode Delay When Entering, sec	<p>Delay time when entering in the <b>Night Mode</b>: from 5 to 120 seconds.</p> <p>Delay when entering (alarm activation delay) is the time the user has to disarm the security system after entering the premises.</p> <p><b>Delays work only with the motion sensor.</b></p> <p><a href="#"><u>Learn more</u></a></p>
Night Mode Delay When Leaving, sec	<p>Delay time when leaving in the <b>Night Mode</b>: from 5 to 120 seconds.</p> <p>Delay when leaving is the time the user has to leave the premises after the security system arming.</p> <p><b>Delays work only with the motion sensor.</b></p> <p><a href="#"><u>Learn more</u></a></p>
Firmware	Detector firmware version.
Device ID	Detector ID. Also, available on the QR code on the detector enclosure and its package box.
Device No.	Number of the device loop (zone).

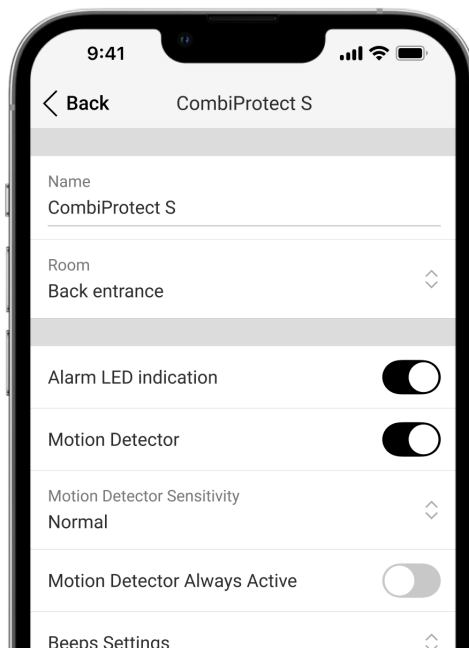
## Settings



To change **CombiProtect S Jeweller** settings in the Ajax app:

1. Go to the **Devices**  tab.
2. Select **CombiProtect S** from the list.
3. Go to **Settings** by clicking on the gear icon .
4. Set the required parameters.
5. Click **Back** to save the new settings.

Setting	Meaning
Name	<p>Name of the detector. Displayed in the list of hub devices, text of SMS and notifications in the events feed.</p> <p>To change the name of the module, click on the text field.</p> <p>The name can contain up to 12 Cyrillic characters or up to 24 Latin characters.</p>
Room	<p>Selecting the virtual room to which <b>CombiProtect S</b> is assigned.</p> <p>The room name is displayed in the text of SMS and notifications in the events feed.</p>



Alarm LED indication	When the option is disabled, the LED indicator of the detector doesn't notify about alarms or tamper triggering.
Motion Detector	If active, motion detector will be active.
Motion Detector Sensitivity	<p>Choosing the sensitivity level of the motion detector:</p> <ul style="list-style-type: none"> <li>• <b>Low.</b></li> <li>• <b>Normal.</b></li> <li>• <b>High.</b></li> </ul> <p><b><u>Why motion detectors react to animals and how to avoid it</u></b></p>
Motion Detector Always Active	If active, the detector always registers motion.
Glass Break Detector	If active, glass breaking detector will be active.
Glass Break Detector Sensitivity	<p>Choosing the sensitivity level of the glass detector:</p> <ul style="list-style-type: none"> <li>• <b>Low.</b></li> <li>• <b>Normal.</b></li> <li>• <b>High.</b></li> </ul>
Glass Break Detector Always Active	If active, the detector always registers glass breaking.
<b>Alert with a siren</b>	
If motion detected	If active, <b><u>sirens added to the system</u></b> are activated when the motion detected.
If glass break detected	If active, <b><u>sirens added to the system</u></b> are activated when the glass break detected.
<b>Alarm Reaction</b>	
Operating Mode	<p>Specify how this device will react to alarms:</p> <ul style="list-style-type: none"> <li>• <b>Instant Alarm</b> – the armed detector immediately reacts to a threat and raises the alarm.</li> </ul>

	<ul style="list-style-type: none"> <li>• <b>Entry/Exit</b> – when a delay is set, the armed device starts the countdown and doesn't raise the alarm even if triggered until the countdown ends.</li> <li>• <b>Follower</b> – the detector inherits the delays from Entry/Exit detectors. However, when the Follower is triggered individually, it immediately raises the alarm.</li> </ul>
<p>Delay When Entering, sec</p>	<p>Selecting delay time when entering: 5 to 120 seconds.</p> <p>Delay when entering (alarm activation delay) is the time the user has to disarm the security system after entering the premises.</p> <p><b>Delays work only with the motion sensor.</b></p> <p><a href="#"><u>Learn more</u></a></p>
<p>Delay When Leaving, sec</p>	<p>Selecting delay time when leaving: 5 to 120 seconds.</p> <p>Delay when leaving is the time the user has to leave the premises after arming.</p> <p><b>Delays work only with the motion sensor.</b></p> <p><a href="#"><u>Learn more</u></a></p>
<p>Arm in Night Mode</p>	<p>If this option is enabled, the detector will go into the armed mode when the system is set to the <b>Night Mode</b>.</p> <p><a href="#"><u>Learn more</u></a></p>
<p>Night Mode Delay When Entering, sec</p>	<p>Delay time when entering in the <b>Night Mode</b>: from 5 to 120 seconds.</p> <p>Delay when entering (alarm activation delay) is the time the user has to disarm the security system after entering the premises.</p> <p><b>Delays work only with the motion sensor.</b></p>

	<p><a href="#"><u>Learn more</u></a></p>
Night Mode Delay When Leaving, sec	<p>Delay time when leaving in the <b>Night Mode</b>: from 5 to 120 seconds.</p> <p>Delay when leaving is the time the user has to leave the premises after the security system arming.</p> <p><b>Delays work only with the motion sensor.</b></p> <p><a href="#"><u>Learn more</u></a></p>
Jeweller Signal Strength Test	<p>Switches the detector to the signal strength test mode.</p> <p><a href="#"><u>Learn more</u></a></p>
Detection Zone Test	<p>Switches the detector to the detection area test.</p> <p><a href="#"><u>Learn more</u></a></p>
Signal Attenuation Test	<p>Switches the detector to the signal fade test mode (available in detectors with <b>firmware version 3.50 and later</b>).</p> <p><a href="#"><u>Learn more</u></a></p>
User Guide	<p>Opens the CombiProtect S user manual in the Ajax app.</p>
Permanent Deactivation	<p>Allows the user to disable the device without removing it from the system.</p> <p>Three options are available:</p> <ul style="list-style-type: none"> <li>• <b>No</b> – the device operates in normal mode and transmits all events.</li> <li>• <b>Entirely</b> – the device does not execute system commands and does not participate in automation scenarios, and the system ignores alarms and other device notifications.</li> <li>• <b>Lid only</b> – the system ignores the detector tamper triggering notifications.</li> </ul>

	<p><a href="#"><u>Learn more</u></a></p> <p>The system can also automatically deactivate devices when the preset number of alarms is exceeded.</p> <p><a href="#"><u>Learn more</u></a></p>
One-Time Deactivation	<p>Allows the user to disable events of the device until the first disarm.</p> <p>Three options are available:</p> <ul style="list-style-type: none"> <li>• <b>No</b> – the device operates in normal mode and transmits all events.</li> <li>• <b>Entirely</b> – the device is entirely excluded from the operation of the system until the first disarm. The device does not execute system commands and does not report alarms or other events.</li> <li>• <b>Lid Only</b> – notifications on the tamper triggering are disabled until the first disarm.</li> </ul> <p><a href="#"><u>Learn more</u></a></p>
Unpair Device	<p>Disconnects the detector from the hub and deletes its settings.</p>

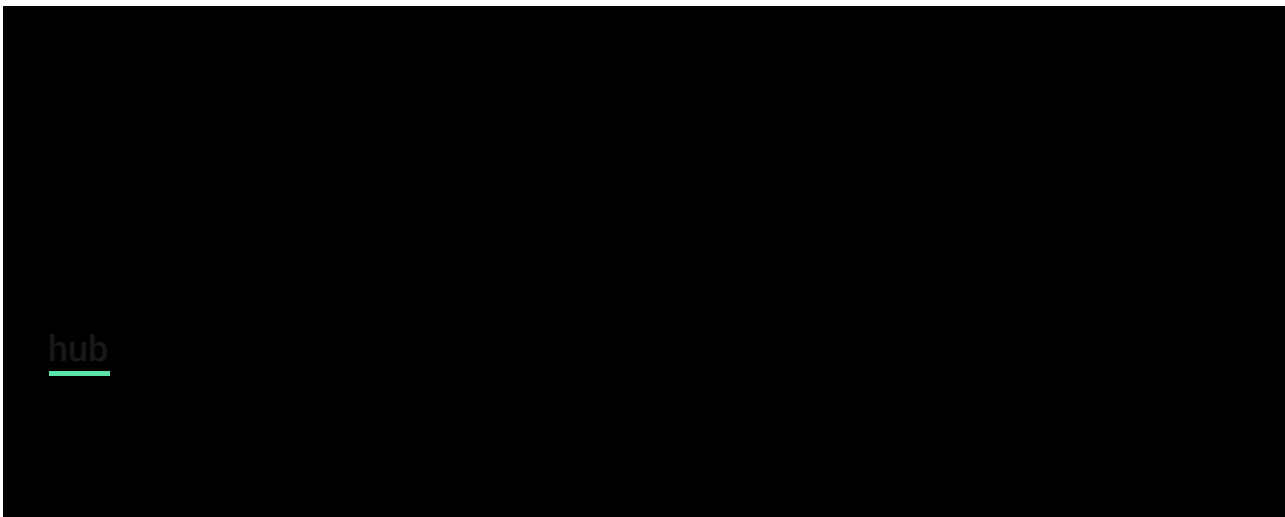

## Indication

		
Battery needs replacing	During the alarm, it slowly lights up green and goes off.	Replacement of the detector battery is described in the <a href="#"><u>Battery replacement</u></a> manual.

## Functionality testing

The Ajax system offers several tests to help select the device installation place. Tests do not start immediately. However, the waiting time does not exceed the duration of one “hub–device” polling interval. The polling interval can be checked and configured at hub settings (**Hub** → **Settings**  → **Jeweller** or **Jeweller/Fibra**).

### To run a test in the Ajax app:

1. Select the required hub.
2. Go to the **Devices**  tab.
3. Select **CombiProtect S** from the list.
4. Go to **Settings** .
5. Select a test:
  1. [Jeweller Signal Strength Test](#).
  2. [Signal Attenuation Test](#).
  3. [Detection Zone Test](#).
6. Run the test.

# Detector placement





The device is designed for indoor use only.

When choosing where to place **CombiProtect S Jeweller**, consider the parameters that affect its operation:

- Motion detection zone.
- The camera's viewing angle and obstacles in front of it.
- Jeweller signal strength.
- Distance between the detector and the hub.
- Presence of obstacles for radio signal passage: walls, interfloor ceilings, large objects located in the room.

Consider the recommendations for placement when developing a project for the facility's security system. The security system must be designed and installed by specialists. A list of recommended partners is [available here](#).

## Signal strength

The Jeweller signal strength is determined by the number of undelivered or corrupted data packages over a certain period. The icon  on the **Devices**  tab indicates the signal strength:

- **Three bars** – excellent signal strength.
- **Two bars** – good signal strength.
- **One bar** – low signal strength, stable operation is not guaranteed.
- **Crossed out icon** – no signal.



Check the Jeweller signal strength before final installation. With a signal strength of one or zero bars, we do not guarantee the stable operation of the device. Consider relocating

the device, as repositioning even by 20 cm can significantly improve the signal strength. If there is still a poor or unstable signal after the relocation, use a [radio signal range extender](#).

## Detection zone

When choosing the installation place, consider the direction of the lens, viewing angles of the detector and camera, and obstacles impairing the view. The intended path of the intruder must be perpendicular to the axis of the detector's lens. Ensure that furniture, houseplants, vases, and decorative or glass elements do not obstruct the view of the detector.

The direction of the detector lens should be perpendicular to an alleged intrusion path into the facility.

The detector microphone should be positioned at an angle of no more than 90 degrees relative to the window.

We recommend installing the detector at a height of 2.4 meters.

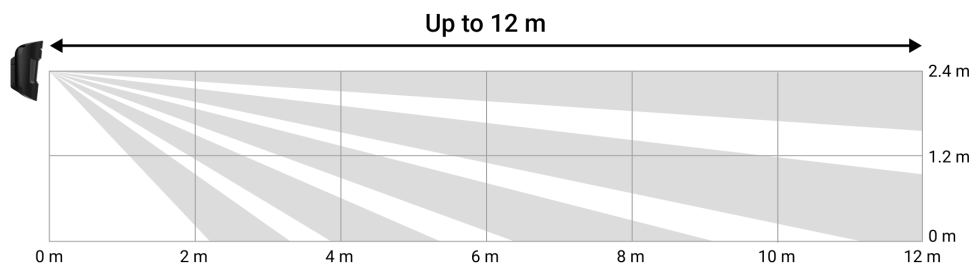

Vertical viewing angle of the detector

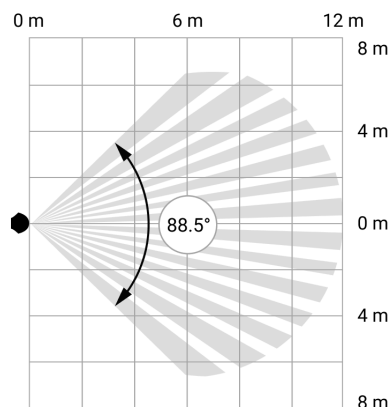

Horizontal viewing angle of the detector

When installing the detector, perform the Detection Zone Test. This allows you to check the operation of the device and accurately determine the sector in which the detector registers motion.

If the detector is not installed at the recommended height, this will reduce the area of the motion detection zone and impair the operation of the function of ignoring animals.

### Why motion detectors react to animals and how to avoid it

## How not to install the detector

1. Outdoors. This can lead to false alarms and detector failure.
2. In the direction where direct sunlight hits the detector lens. This can lead to false alarms.
3. Opposite any objects with rapidly changing temperature, like any electric or gas heater. This can lead to false alarms.
4. Opposite any moving objects with a temperature close to the human body. For example, in front of swaying curtains above a radiator. This can lead to false alarms.
5. In places with fast air circulation. For example, near fans, air conditioners, open windows, or doors. This can lead to false alarms.
6. Nearby any metal objects or mirrors causing attenuation and screening of the signal.
7. Inside premises with temperature and humidity outside the permissible limits. This could damage the detector.
8. Closer than 1 meter from the hub or radio signal range extender. This can lead to a loss of communication with the detector.
9. In a place with a low signal level. This may result in the loss of the connection with the hub.

## Installation



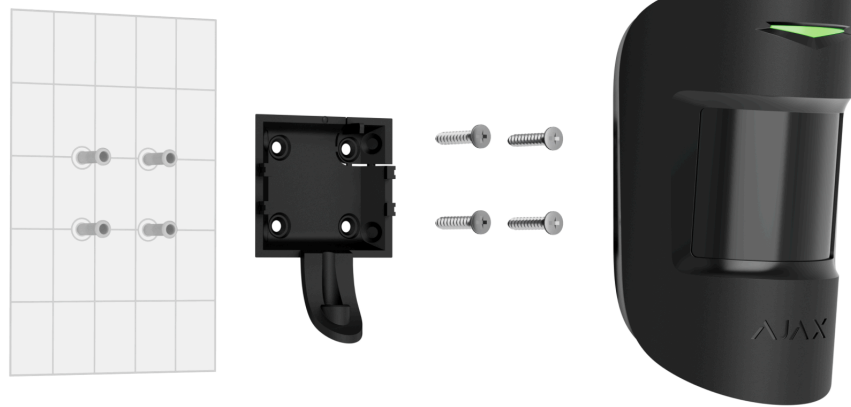

Before installing the detector, ensure that you have selected the optimal location and it complies with the guidelines in this manual.

### To mount a detector:

1. Begin by loosening the holding screw. Remove the SmartBracket mounting panel from the detector by sliding it down.
2. Fix the SmartBracket panel using double-sided tape or other temporary fasteners. The panel can be mounted on a vertical surface or in a corner of the room. **The installation height is 2.4 meters.**

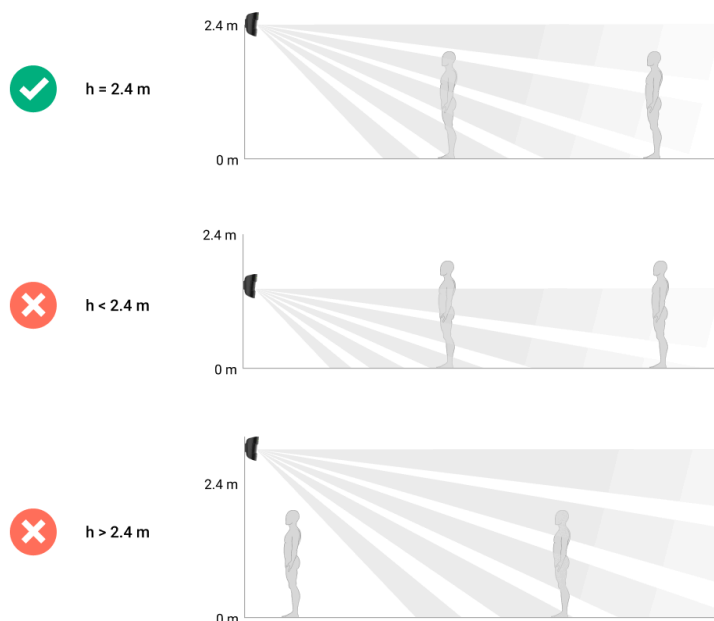



Use double-sided tape only for temporary installation. The device attached to the tape may come unstuck from the surface anytime. As long as the device is taped, the tamper will not be triggered when detached from the surface.

3. Place the detector on SmartBracket. The device's LED indicator will flash. It is a signal indicating that the tamper on the detector is closed.



If the LED indicator doesn't light up while placing the detector on SmartBracket, check the tamper status in the Ajax app, the integrity of the fastening, and the tightness of the detector fixation on the panel.

4. Run the Jeweller signal strength test. The recommended signal strength is two or three bars. If the signal strength is low (a single bar), we do not guarantee stable operation of the device. Consider relocating the device, even as repositioning by 20 cm can significantly improve the signal strength. If there is still a poor or unstable signal after the relocation, use ReX 2 radio signal range extender.
5. Run the Detection zone test. To check the motion detector, walk around the premises while observing the LED and determine the detection zone of the detector. The maximum range of motion detection is 12 meters. If the detector did not respond to movement during the test in 5 out of 5 cases, relocate the device.
6. Remove the detector from SmartBracket.
7. Drill the special recesses on the SmartBracket to secure the panel using the bundled screws. Attach the SmartBracket mounting panel with the bundled screws using all fixation points (one is in the perforated part of the mounting panel above the tamper). When using other fasteners, ensure they do not damage or deform the mounting panel.

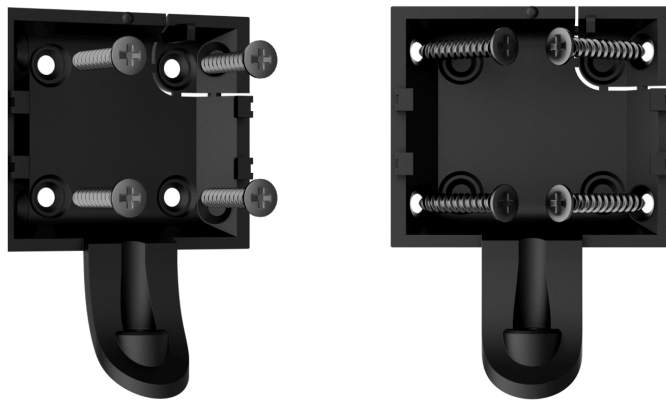

8. Place the detector on the SmartBracket mounting panel.
9. Tighten the holding screw on the bottom of the detector's enclosure for more reliable fastening and protection from quick dismantling.



If the LED indicator of the detector does not activate after installation in the SmartBracket, first check the tamper mode in the Ajax app and then verify the tightness of the panel fixing.

You will receive a notification if the detector is torn off from the surface or removed from the attachment panel.

## Maintenance

Check the functioning of the detector regularly. The optimal frequency of checks is once every three months. Clean the device enclosure of dust, cobwebs, and other contaminants as they emerge. Use soft dry wipes suitable for equipment care.

Do not use substances that contain alcohol, acetone, petrol, and other active solvents to clean the detector. Wipe the detector lens and camera gently: scratches can result in decreased sensitivity of the detector, poor-quality images, and camera failure.

The pre-installed battery ensures up to 5 years of autonomous operation. The security system will send an early warning about replacing the batteries. In case of an alarm, the LED will slowly light up green and go out.

### [How to replace CombiProtect S detector batteries](#)

## Technical specifications

### [All technical specifications of CombiProtect S](#)

### [Compliance with standards](#)

### [Setup in compliance with EN 50131 requirements](#)

## Warranty

Warranty for the Limited Liability Company “Ajax Systems Manufacturing” products is valid for 2 years after the purchase.

If the device does not function correctly, please contact the Ajax Technical Support first. In most cases, technical difficulties can be resolved remotely.

### [Warranty obligations](#)

### [User agreement](#)

### Contact Technical Support:

- [e-mail](#)
- [Telegram](#)

Manufactured by “AS Manufacturing” LLC

Subscribe to the newsletter about safe life. No spam

Email

**Subscribe**