



Monitor  
User Manual



See Far, Go Further

# Legal Information

## About this Document

- This Document includes instructions for using and managing the Product. Pictures, charts, images and all other information hereinafter are for description and explanation only.
- The information contained in the Document is subject to change, without notice, due to firmware updates or other reasons. Please find the latest version of the Document at the Hikvision website (<https://www.hikvision.com>). Unless otherwise agreed, Hangzhou Hikvision Digital Technology Co., Ltd. or its affiliates (hereinafter referred to as "Hikvision") makes no warranties, express or implied.
- Please use the Document with the guidance and assistance of professionals trained in supporting the Product.

## About this Product

This product can only enjoy the after-sales service support in the country or region where the purchase is made.

## Acknowledgment of Intellectual Property Rights

- Hikvision owns the copyrights and/or patents related to the technology embodied in the Products described in this Document, which may include licenses obtained from third parties.
- Any part of the Document, including text, pictures, graphics, etc., belongs to Hikvision. No part of this Document may be excerpted, copied, translated, or modified in whole or in part by any means without written permission.
- **HIKVISION** and other Hikvision's trademarks and logos are the properties of Hikvision in various jurisdictions.
- Other trademarks and logos mentioned are the properties of their respective owners.

-  **HDMI**<sup>TM</sup> The terms HDMI, HDMI High-Definition Multimedia

HIGH-DEFINITION MULTIMEDIA INTERFACE

Interface, HDMI Trade dress and the HDMI Logos are trademarks or registered trademarks of HDMI Licensing Administrator, Inc.

## LEGAL DISCLAIMER

- TO THE MAXIMUM EXTENT PERMITTED BY APPLICABLE LAW, THIS DOCUMENT AND THE PRODUCT DESCRIBED, WITH ITS HARDWARE, SOFTWARE AND FIRMWARE, ARE PROVIDED "AS IS" AND "WITH ALL FAULTS AND ERRORS". HIKVISION MAKES NO WARRANTIES, EXPRESS OR IMPLIED, INCLUDING WITHOUT LIMITATION, MERCHANTABILITY, SATISFACTORY QUALITY, OR FITNESS FOR A PARTICULAR PURPOSE. THE USE OF THE PRODUCT BY YOU IS AT YOUR OWN RISK. IN NO EVENT WILL HIKVISION BE LIABLE TO YOU FOR ANY SPECIAL, CONSEQUENTIAL, INCIDENTAL, OR INDIRECT DAMAGES, INCLUDING, AMONG OTHERS, DAMAGES FOR LOSS OF BUSINESS PROFITS, BUSINESS INTERRUPTION, OR LOSS OF DATA, CORRUPTION OF SYSTEMS, OR LOSS OF DOCUMENTATION, WHETHER BASED ON BREACH OF CONTRACT, TORT (INCLUDING NEGLIGENCE), PRODUCT LIABILITY, OR OTHERWISE, IN CONNECTION WITH THE USE OF THE PRODUCT, EVEN IF HIKVISION HAS BEEN ADVISED OF THE POSSIBILITY OF SUCH DAMAGES OR LOSS.
- YOU ACKNOWLEDGE THAT THE NATURE OF THE INTERNET PROVIDES FOR INHERENT SECURITY RISKS, AND HIKVISION SHALL NOT TAKE ANY RESPONSIBILITIES FOR ABNORMAL OPERATION, PRIVACY LEAKAGE OR OTHER DAMAGES RESULTING FROM CYBER-ATTACK, HACKER ATTACK, VIRUS INFECTION, OR OTHER INTERNET SECURITY RISKS; HOWEVER, HIKVISION WILL PROVIDE TIMELY TECHNICAL SUPPORT IF REQUIRED.
- YOU AGREE TO USE THIS PRODUCT IN COMPLIANCE WITH ALL APPLICABLE LAWS, AND YOU ARE SOLELY RESPONSIBLE FOR ENSURING THAT YOUR USE CONFORMS TO THE APPLICABLE LAW. ESPECIALLY, YOU ARE RESPONSIBLE, FOR USING THIS PRODUCT IN A MANNER THAT DOES NOT INFRINGE ON THE RIGHTS OF THIRD PARTIES, INCLUDING WITHOUT LIMITATION, RIGHTS OF PUBLICITY, INTELLECTUAL PROPERTY RIGHTS, OR DATA PROTECTION AND OTHER PRIVACY RIGHTS. YOU SHALL NOT USE THIS PRODUCT FOR ANY PROHIBITED END-USES, INCLUDING THE DEVELOPMENT OR PRODUCTION OF WEAPONS OF MASS DESTRUCTION, THE DEVELOPMENT OR PRODUCTION OF CHEMICAL OR BIOLOGICAL WEAPONS, ANY ACTIVITIES IN THE CONTEXT RELATED TO ANY NUCLEAR EXPLOSIVE OR UNSAFE NUCLEAR FUEL-CYCLE, OR IN SUPPORT OF HUMAN RIGHTS ABUSES.
- IN THE EVENT OF ANY CONFLICTS BETWEEN THIS DOCUMENT AND THE APPLICABLE LAW, THE LATTER PREVAILS.



© Hangzhou Hikvision Digital Technology Co., Ltd. All rights reserved.

## Applicable Models

This manual is applicable to the model: Monitor.

## Symbol Conventions

The symbols that may be found in this document are defined as follows.

Symbol	Description
 <b>Note</b>	Provides additional information to emphasize or supplement important points of the main text.
 <b>Caution</b>	Indicates a potentially hazardous situation, which if not avoided, could result in equipment damage, data loss, performance degradation, or unexpected results.
 <b>Danger</b>	Indicates a hazard with a high level of risk, which if not avoided, will result in death or serious injury.

## Safety Instructions

- **Caution:** The device may generate radio interference in indoor environment. Necessary precautions may be required.
- In the use of the product, you must be in strict compliance with the electrical safety regulations of the nation and region.
- Input voltage should meet both the SELV (Safety Extra Low Voltage) and the Limited Power Source with 100 to 240 VAC or 12 VDC/2A according to the IEC60950-1 standard.
- If the device uses a 3-prong power supply plug, it must be connected to an earthed mains socket-outlet properly.

- For the device powered on and off only by power plug and socket-outlet, the socket-outlet shall be installed near the device and shall be easily accessible.
- Do not touch the bare components (such as the metal contacts of the inlets) and wait for at least 5 minutes, since electricity may still exist after the device is powered off.
- For the device with the sign ⚡ indicating hazardous live, the external wiring connected to the terminals requires installation by an instructed person.
- Never place the device in an unstable location. The device may fall, causing serious personal injury or death.
- If the device supports wall mounting or ceiling mounting, the mounting surface shall be able to withstand the additional force of three times the weight of the device but not less than 50 N. The device and its associated mounting means shall remain secure during the installation.
- If the device contains a coin/button cell battery:
  1. Do not ingest battery. Chemical Burn Hazard!
  2. This product contains a coin/button cell battery. If the coin/button cell battery is swallowed, it can cause severe internal burns in just 2 hours and can lead to death.
  3. Keep new and used batteries away from children.
  4. If the battery compartment does not close securely, stop using the product and keep it away from children.
  5. If you think batteries might have been swallowed or placed inside any part of the body, seek immediate medical attention.
  6. CAUTION: Risk of explosion if the battery is replaced by an incorrect type.
  7. Improper replacement of the battery with an incorrect type may defeat a safeguard (for example, in the case of some lithium battery types).
  8. Do not dispose of the battery into fire or a hot oven, or mechanically crush or cut the battery, which may result in an explosion.
  9. Do not leave the battery in an extremely high temperature surrounding environment, which may result in an explosion or the leakage of flammable liquid or gas.
  10. Do not subject the battery to extremely low air pressure, which may result in an explosion or the leakage of flammable liquid or gas.
  11. Dispose of used batteries according to the instructions.
- ALWAYS use cabinets or stands or mounting methods recommended by the manufacturer of the device set.
- ALWAYS use furniture that can safely support the device set.
- ALWAYS ensure the device set is not overhanging the edge of the supporting furniture.
- ALWAYS route cords and cables connected to your device so they cannot be tripped over, pulled or grabbed.
- NEVER place a device set in an unstable location.
- NEVER place the device set on tall furniture (for example, cupboards or bookcases) without anchoring both the furniture and the device set to a suitable support.
- NEVER place the device set on cloth or other materials that may be located between the device set and supporting furniture.
- NEVER place items that might tempt children to climb, such as toys and remote controls, on the top of the device or furniture on which the device is placed.
- For the device with sound playing function, to prevent possible hearing damage, do not listen at high volume levels for long periods.

### **Caution**

- If the ingress protection level is lower than IPx4, the device shall not be exposed to water dripping or splashing and that no objects filled with liquids, such as vases, shall be placed on the equipment.
- Provide a surge suppressor at the inlet opening of the device under special conditions such as the mountain top, iron tower, and forest.
- If the device is powered by terminals connected to the power cord, ensure correct voltage and wiring of the terminals for connection to mains supply.
- For the device with ventilation openings, the ventilation openings should not be impeded by covering the ventilation openings with items, such as newspapers, table-cloths, and curtains. The openings shall never be blocked by placing the device on a bed, sofa, rug, or other similar surface.
- If the device has ventilation openings and distance requirements for heat dissipation, keep a proper distance around the device for sufficient ventilation.
- If the device installation is needed,
  1. Install the device according to the instructions in User Manual.
  2. To prevent injury, this device must be securely attached to the installation surface in accordance with the installation instructions.
- Keep vertical when moving or using the device.
- CAUTION: If the bracket is designed for a specific device model of our company, use the bracket with the corresponding device only. Use with other devices may result in instability and cause injury.
- CAUTION: If the device needs to be installed with a specific bracket of our company, use the corresponding bracket only. Use others (such as carts, stands, and carriers) may result in instability and cause injury. Refer to the device datasheet for bracket model details.
- The interface varies with the models. Please refer to the product datasheet for details.
- If the device is not released with a power adapter, and you need to wire the bare cables of the device:
  - The device external wiring connected to the hazardous live terminals requires installation by an instructed person.
  - Make sure that the power has been disconnected before you wire, install, or disassemble the device.
  - The power supply or device must be connected to an earthed mains socket-outlet.
  - High voltage for the power supply. Do not disassemble it.
  - If smoke, odor, or noise arises from the power supply or device, immediately turn off the power, unplug the power cable, and contact the service center.
- If the device needs to be wired by yourself, select the corresponding wire to supply power according to the electric parameters labeled on the device. Strip off wire with a standard wire stripper at corresponding position. To avoid serious consequences, the length of stripped wire shall be appropriate, and conductors shall not be exposed.
- If a power adapter is provided in the device package, use the provided adapter only.

# 1. Product Introduction

## 1.1 Front Panel

Buttons on the front panel of the device are shown as follows.



Figure 1-1 Buttons and Power Indicator on the Front Panel

Table 1-1 Buttons and Power Indicator Description

Button/Power Indicator	Description
	<ul style="list-style-type: none"> <li>OSD page: Switch to the next page or the parameter of sub menu page.</li> <li>Other pages: Show all signal sources on screen.</li> </ul>
	<ul style="list-style-type: none"> <li>Main menu page: Switch to different parameters.</li> <li>Sub menu page: Add or decrease the value of the parameter.</li> </ul>
	<ul style="list-style-type: none"> <li>OSD page: Confirm.</li> <li>Other pages: Show the current input signal source.</li> </ul>
	<ul style="list-style-type: none"> <li>OSD page: Short press to return to the previous page or exit the OSD page.</li> <li>Signal Source page: Exit the signal source page.</li> <li>Other pages: Enter the OSD page.</li> </ul>
	<p>Power Switch.</p> <ul style="list-style-type: none"> <li>Working state: <ul style="list-style-type: none"> <li>When the screen is off, short press to restore the display.</li> <li>Short press for 3s to turn off the device, the device will enter off mode.</li> </ul> </li> <li>Shutdown state: Short press to turn on the device, the device will exit off mode.</li> </ul>
	<p>Power Indicator.</p> <ul style="list-style-type: none"> <li>When the device is in off mode and network standby mode, the power indicator light is solid white.</li> <li>When the device is turned on, the power indicator light is off.</li> </ul>

## 1.2 Rear Panel

The interfaces that may be found on the rear panel of the device are defined as follows.

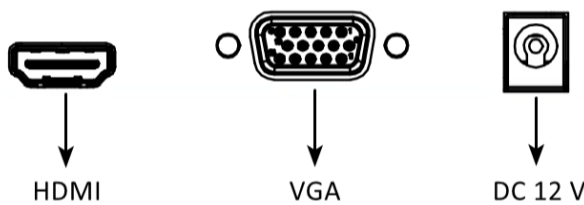

Figure 1-2 Rear Panel Interface 1

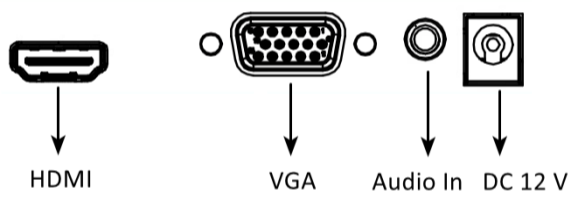

Figure 1-3 Rear Panel Interface 2

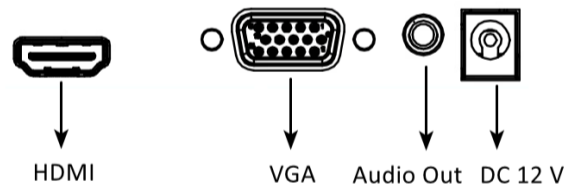

Figure 1-4 Rear Panel Interface 3

Table 1-2 Interface Description

Interface	Description	Interface	Description
HDMI	HDMI digital signal input interface	VGA	VGA analog signal input interface
Audio In	3.5 mm audio input interface	Audio Out	3.5 mm audio output interface
DC 12 V	DC power adapter interface		

### Note

The figures are for reference only. The actual device prevails.

## 2. Installation and Cable Connection

### Note

The installation drawings are for reference only.

### 2.1 Install the Square Base

Step 1 Gently lift the device. Place the screen down on a stable surface covered with a thick soft cloth so that the bottom of the device is close to the edge of the surface for mounting the bracket.

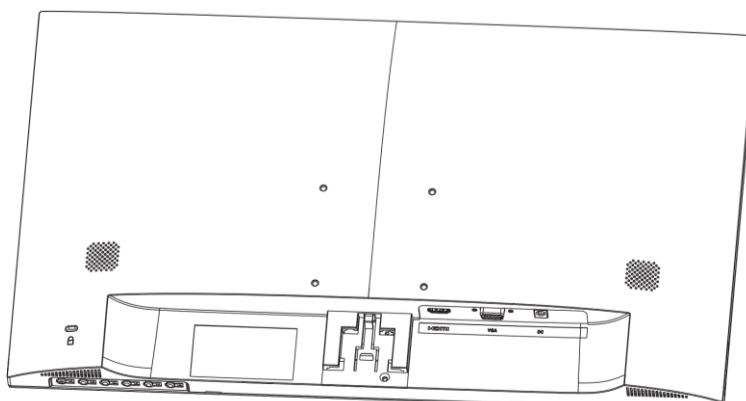

Figure 2-1 Place the Device Flatly (Model A)

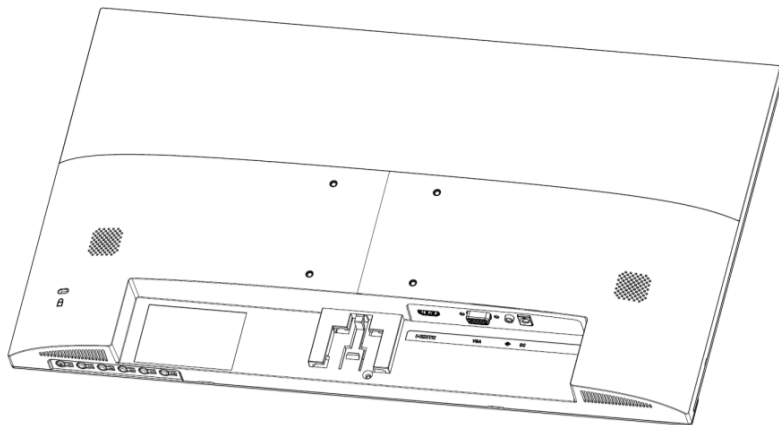

Figure 2-2 Place the Device Flatly (Model B)

Step 2 Take out the bracket, cable ties, and square base from the packing box. Align the cable ties with the holes in the bracket and insert the cable ties into the bracket. Then align the bracket with the buckle on the base and fix the bracket clockwise.

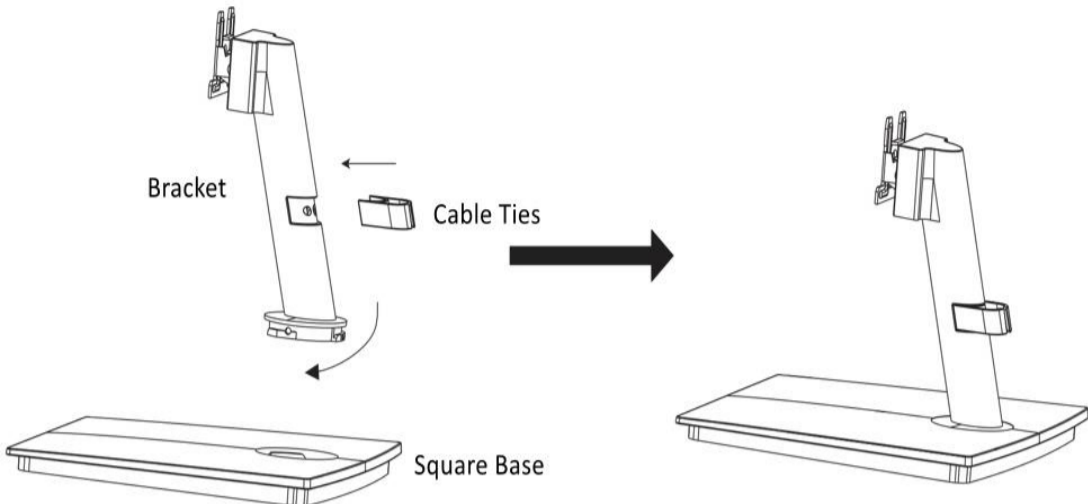

Figure 2-3 Fix the Bracket with the Square Base

Step 3 Align the metal parts on the bracket of square base with the slots at the back of the device and insert them.

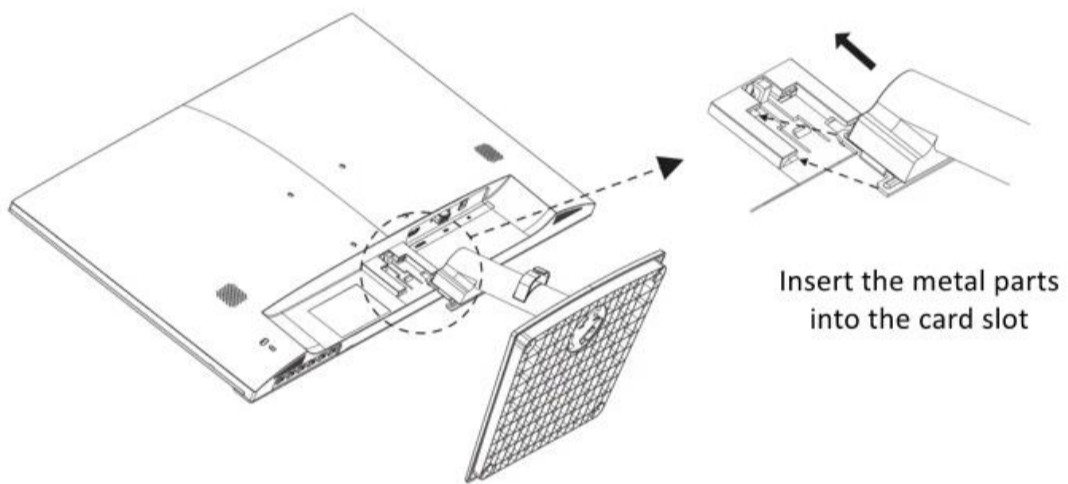

Figure 2-4 Insert the Metal Parts (Model A)

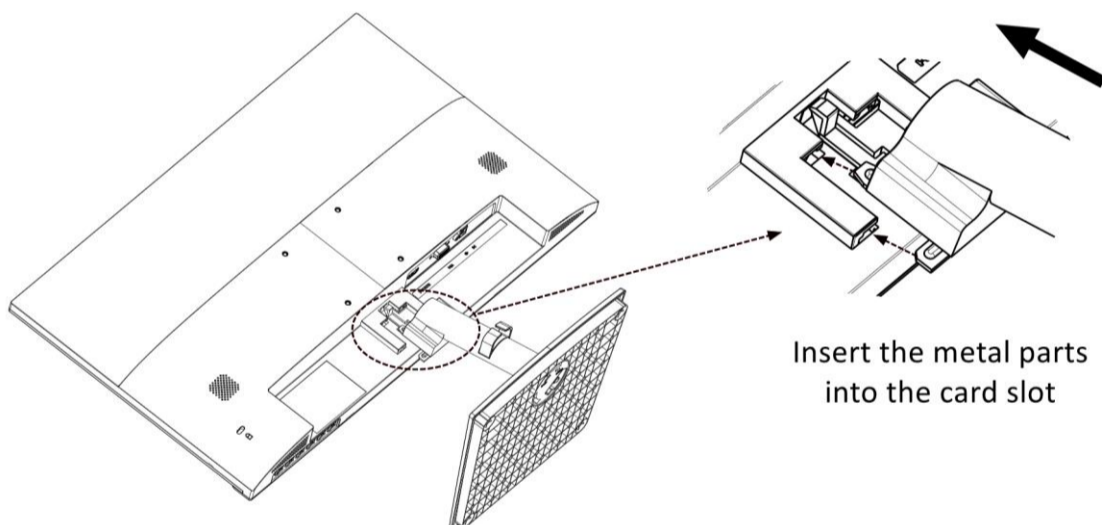

Figure 2-5 Insert the Metal Parts (Model B)

Step 4 Installation finished.

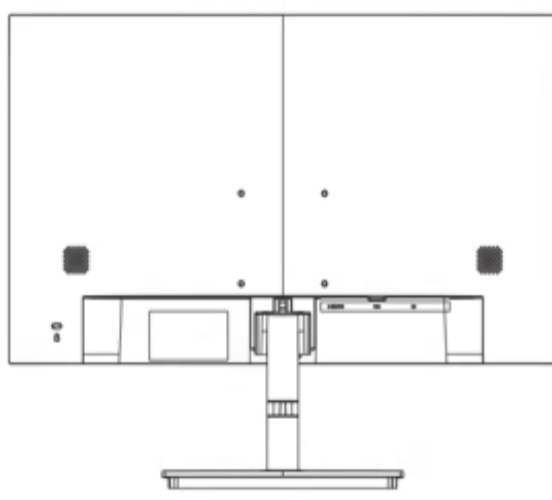

Figure 2-6 Fix the Bracket with the Device (Model A)

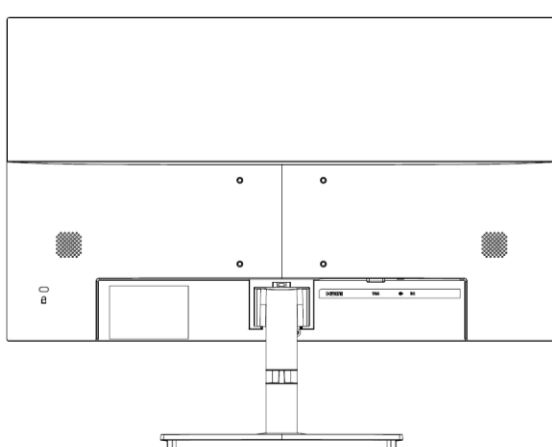

Figure 2-7 Fix the Bracket with the Device (Model B)

Step 5 (Optional) To remove the square base, perform the following operations.

- 1) Press and hold the snapback on the back of the device, pan down and pull out the bracket.

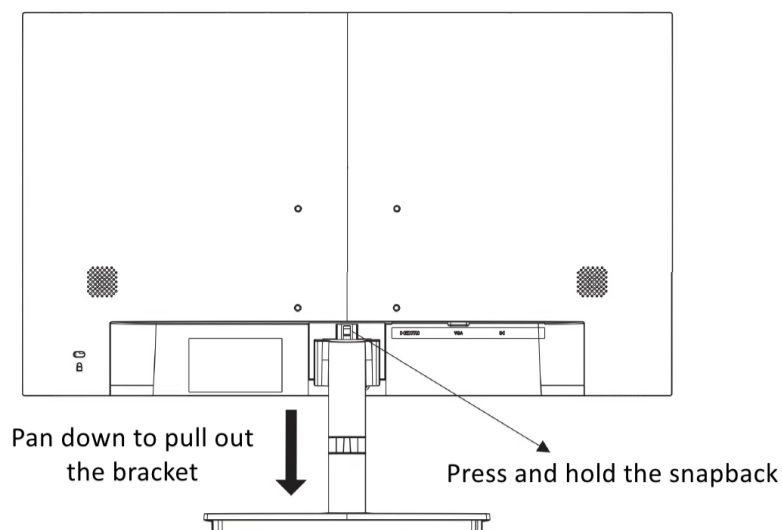

Figure 2-8 Remove the Device and Bracket (Model A)

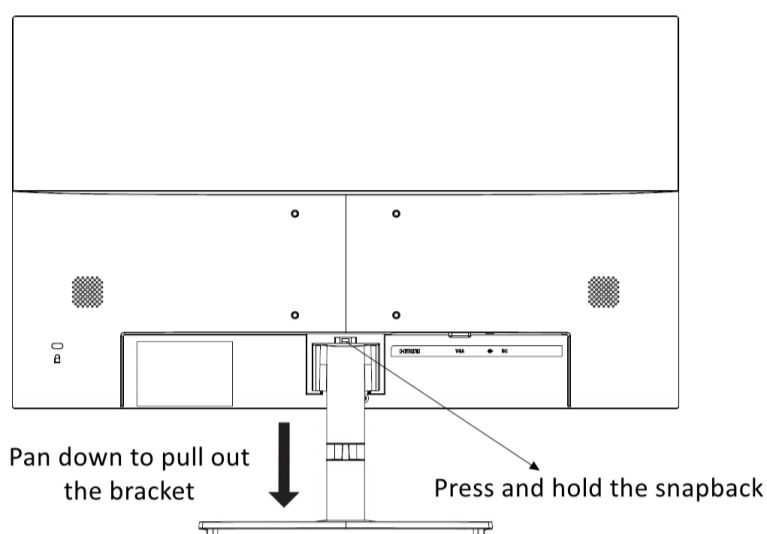

Figure 2-9 Remove the Device and Bracket (Model B)

- 2) Fasten the buckle at the bottom of the base with your finger, and rotate the bracket in the direction indicated by OPEN to remove it from the square base.

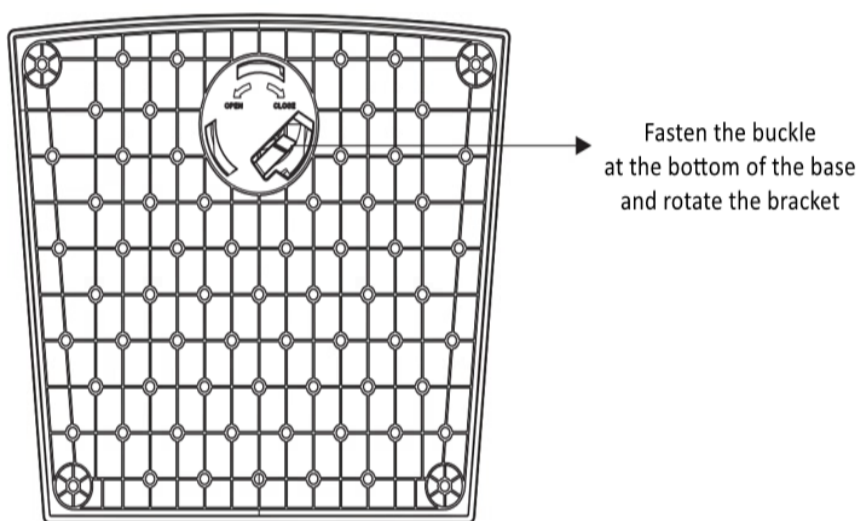

Figure 2-10 Remove the Bracket from the Square Base

## 2.2 Install the Herringbone Base

Step 1 Gently lift the device and place the screen down on a stable surface covered with a thick soft cloth so that the bottom of the device is close to the edge of the surface for mounting the bracket.

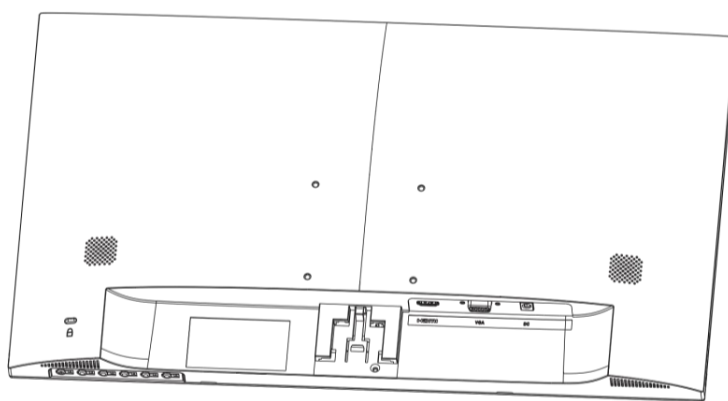

Figure 2-11 Place the Device Flatly (Model A)

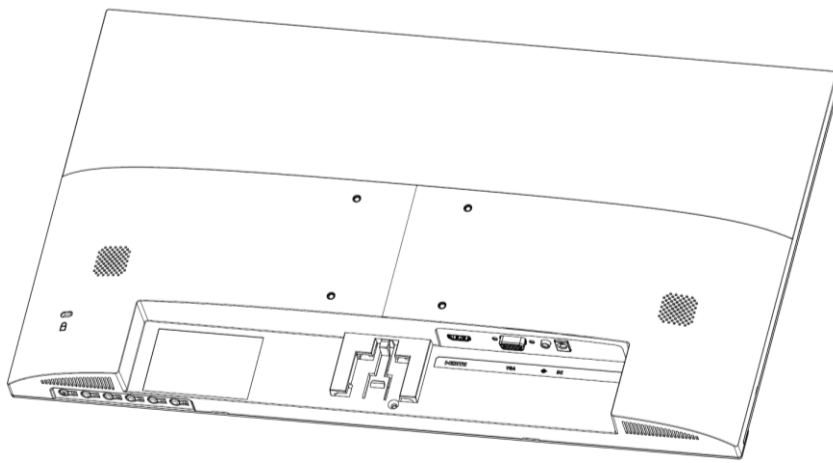

Figure 2-12 Place the Device Flatly (Model B)

Step 2 Take out the bracket and the herringbone base from the packing box.

- Install Bracket and Base (Model A)

Insert the bracket downward into the grooves of the herringbone base. Tighten the screw at the bottom of the base to secure the bracket to the base. Install the bracket on the herringbone base.

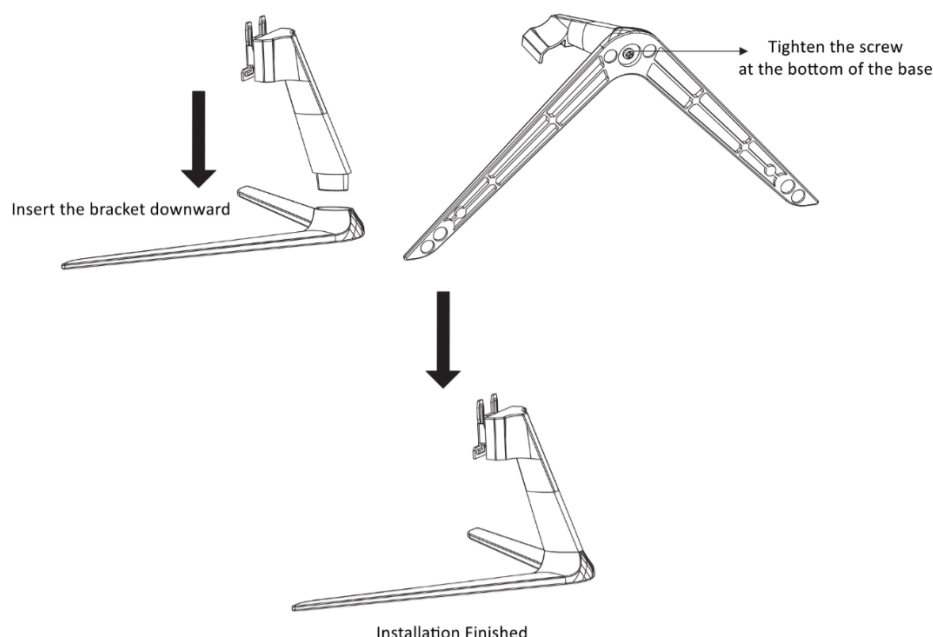

Figure 2-13 Install Bracket and Base (Model A)

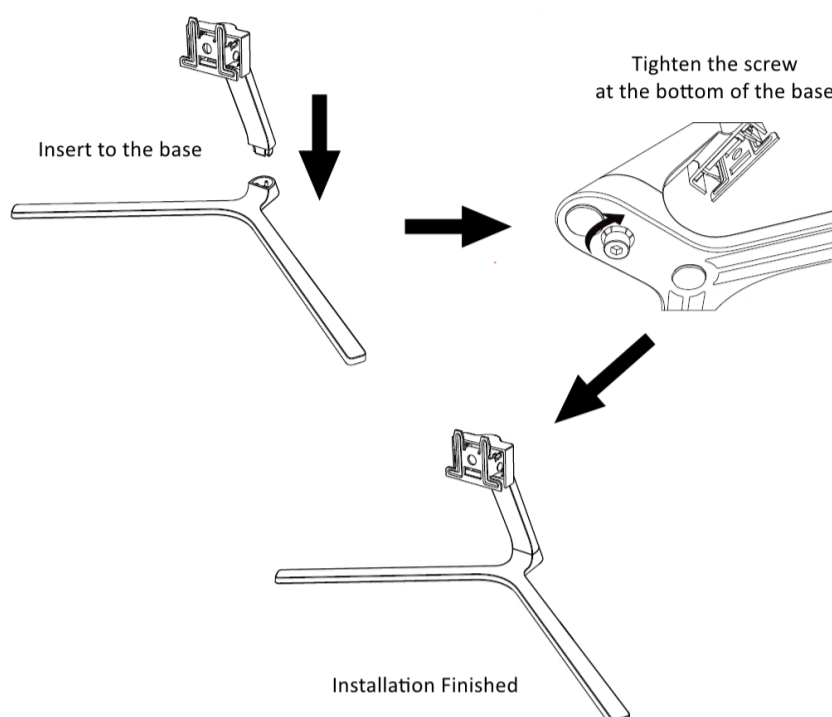

Figure 2-14 Install Bracket and Base (Model B)

● Install Bracket and Base (Model C)

Insert the bracket downward into the grooves of the herringbone base until you hear a click.

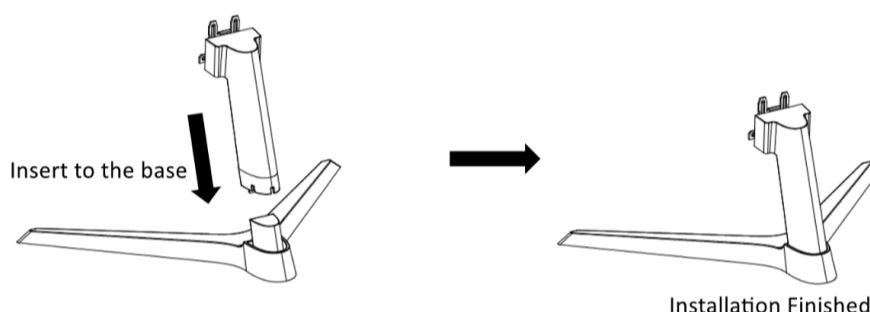

Figure 2-15 Install Bracket and Base (Model C)

Step 3 Fix the bracket with the device. For details about how to secure a square base, see 2.1 Step 3.

Step 4 (Optional) If the herringbone base needs to be removed, remove the bracket and device in the same way as the square base. For details, see 2.1 Step 5. When removing the bracket and base, loosen the screw at the bottom of the herringbone base and lift out the bracket.



## 2.3 Connect the Power Cord and Signal Cables

Step 1 Connect the device to an earthed mains socket-outlet with the power adapter.

Step 2 Connect the input signal source device with HDMI signal cable or VGA signal cable.

Step 3 Turn on the device.

### ⚠ Caution

- Power supply: DC 12 V, 2 A.
- Power off the device and disconnect the plug if it is not in use for a long time, then the device will enter off mode.
- Short press  on the front panel of the device to enter off mode. Short press  again to exit the off mode and wake up the screen.
- Standby Power Consumption: no more than 0.5 W.
- When the device is powered on and no HDMI or VGA signal is input, the screen will show a “No Signal” prompt and go to sleep mode in 10 minutes, that is, the device will enter network standby mode and run at the lowest power consumption. After receiving the HDMI or VGA signal source or short pressing , the device will exit the network standby mode and the screen will be woken up.
- Network Standby Power Consumption: no more than 2.0 W.
- The device may restart under harsh electromagnetic conditions. Wait 1 to 2 minutes for automatic recovery.

## 3. OSD Operations

### 3.1 Select the Signal Source

Step 1 Connect the power cord and signal cables, turn on the device.

Step 2 Press  and enter the signal source page.

Step 3 Press  to select the signal source, and press  to confirm.

Step 4 Press  to exit the signal source page.

### 3.2 Operate the OSD

Step 1 Short press  to enter the OSD page.

Step 2 View the main menu page.

- 1) Short press < or > to view the main menu page.
- 2) Short press → to switch to different main menu pages.

Step 3 View the sub-menu page.

- 1) Short press □ to enter the sub-menu page.
- 2) Short press → to switch to different sub-menu pages.

Step 4 Adjust parameters.





- 1) Short press < or > to adjust the value of parameter.
- 2) Short press → to switch to different parameters.

Step 5 After adjustment, short press □ to return to the main menu page.

Step 6 Short press □ again to exit the OSD page.

### 3.3 OSD Function

Table 3-1 OSD Function Description

Main Menu	Sub Menu	Description
Signal Source	Auto	Switch VGA signal source and HDMI signal source automatically.
	VGA	VGA signal source input.
	HDMI	HDMI digital signal source input.
	Image Mode	<ul style="list-style-type: none"> <li>● <b>Security:</b> Suitable for playing surveillance images.</li> <li>● <b>Text:</b> Suitable for presenting text-based content.</li> <li>● <b>Movie:</b> Suitable for playing movies.</li> <li>● <b>User:</b> Set the brightness, contrast, color, or sharpness to adjust display effect.</li> </ul>
	Brightness	The higher the value is, the brighter the display will be.
	Contrast	The higher the value is, the clearer the display will be.
	Color	The higher the value is, the more colorful the display will be.
	Sharpness	Increase the value to make the image more vivid.
	MPRT	100 Hz refresh rate or higher is required for MPRT under HDMI input signal source. Once enabled, the image motion blur can be reduced by controlling backlight flickering to enhance the clarity of dynamic images and ensure smoother display effect of fast-moving objects.
	Color Space	Under HDMI input signal source, three color space modes are supported: Auto (default), 0 to 255, and 16 to 235. In Auto mode, the system will automatically adapt to the corresponding color space based on the color space of input signal source. Users can manually select either 0 to 255 or 16 to 235 mode for proper adaptation when the color space identification of the signal source output does not match.
	Eye Care Mode	When enabled, it can effectively reduce blue light radiation, alleviate eye fatigue, and protect vision. You can set the level of eye protection level.
	Scaling Mode	Adjust the image scale: the ratio between the width and height of the image.
	Color Temperature	Set the color temperature as required. As the color temperature increases, the color distribution becomes cooler. Alternatively, as the color temperature decreases, the color distribution becomes warmer.
	VGA Auto Adjust	If <b>Auto Adjust</b> is enabled, the related parameters will self-adjust under the following 3 circumstances. The device is restarted, a VGA input source is accessed, and the input source is switched to VGA. VGA parameters cannot be changed when Auto Adjust is disabled.
	Response Time	Once enabled, you can set the response speed level to reduce screen motion blur.
	Adaptive Sync	Support enabling Adaptive Sync technology under HDMI signal source. Once enabled, the refresh rate of the device will synchronize with the frame rate of graphics card of host computer in real-time, thereby reducing screen tearing and stuttering.   <b>Note</b> <ul style="list-style-type: none"> <li>● For the function to be enabled, the graphics card of host computer must support Adaptive Sync.</li> <li>● MPRT and Adaptive Sync cannot be enabled simultaneously.</li> </ul>
	Language	Set the OSD language.
	OSD Duration	Set the time for OSD menu occurrence when there is no operation.
	Auto Sleep	Set the auto sleep time.
	Screen Saver	The background color of the screen when there is no signal.
	Mute	Mute or unmute the device.
	Volume	Adjust the volume of the device.
	User Reset	Reset to default settings except language.
	Software Version	Software version of the device.
	Serial Number	Serial number of the device.