

Superior MotionProtect Fibra User manual

Updated May 21, 2026



Superior MotionProtect Fibra is a wired motion detector. It can recognize motion at a distance of up to 12 meters*. Does not respond to pets up to 50 centimeters tall and weighing up to 20 kilograms. For indoor installation.



The detector is compatible with [Superior Hub Hybrid \(2G\)](#) and [Superior Hub Hybrid \(4G\)](#). Connection to other [hubs](#), [radio signal range extenders](#), [ocBridge Plus](#), and [uartBridge](#) is not provided.

Superior MotionProtect Fibra works as part of the Ajax system, exchanging data with the hub using the secure Fibra wired protocol. The wired connection range is up to 2,000 meters when using a U/UTP cat.5 twisted pair.

Superior MotionProtect Fibra is a member of the product line of wired Fibra devices. The installation, sale, and administration of these devices are performed only by accredited Ajax partners.

* – for INCERT compliance 10 meters (high sensitivity)

> **Buy Superior MotionProtect Fibra**

Functional elements

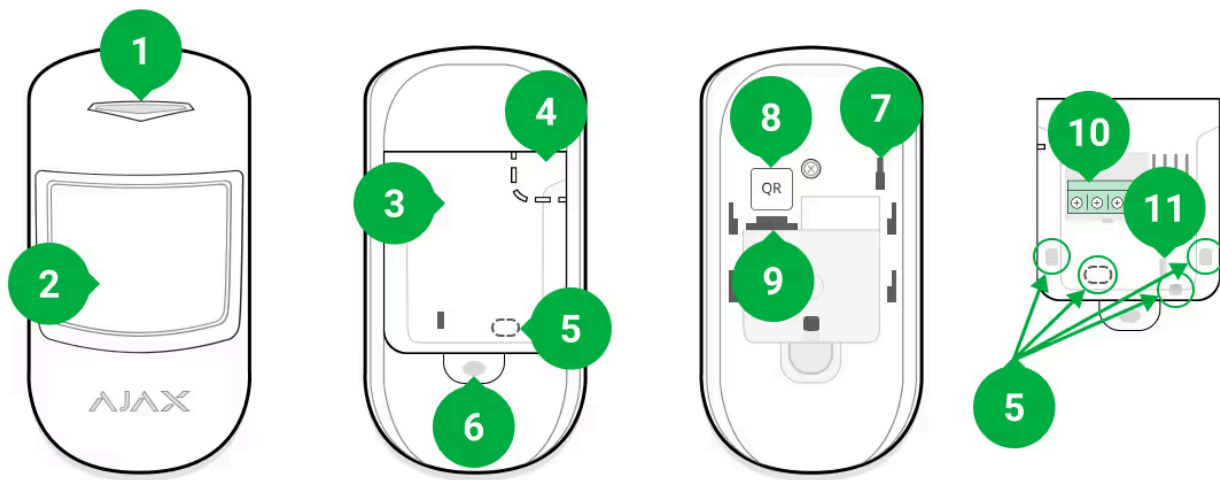

1. LED indicator.
2. Motion detector lens.
3. SmartBracket mounting panel. To remove the panel, slide it down.
4. Perforated part of the mounting panel. Any attempt to detach the detector from the surface triggers a tamper. Do not detach it.
5. Places for drilling holes to output the cables.
6. The hole for attaching the SmartBracket mounting panel with a screw.
7. Tamper button. Triggers when an attempt is made to detach the detector from the surface or remove the mount.
8. QR code and ID (serial number) of the detector. It is used to pair the device with an Ajax system.
9. Terminal strip connection socket.
10. Terminals for connecting the detector to the hub.
11. The hole that allows fixing the wires with wire ties.

Operating principle

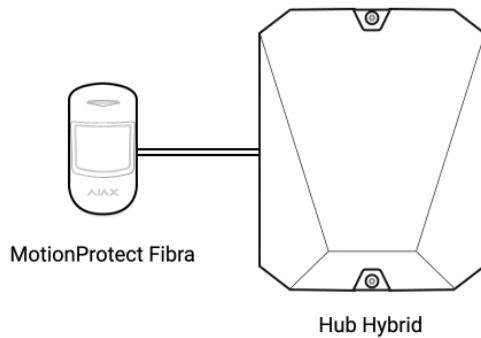

Superior MotionProtect Fibra is a wired motion detector. Using an IR sensor, the detector can identify intrusions by detecting moving objects with temperatures close to that of the human body.

In the armed mode, the detector instantly transmits an alarm signal to the hub when it detects motion. The hub activates connected sirens, runs scenarios, and notifies users and the security company.

All Superior MotionProtect Fibra alarms and events are recorded in the notification feed of the Ajax app. Users know exactly where motion is detected. The notifications contain the name of the hub (the name of the protected object), the name of the device, and the virtual room to which the detector is assigned.

How Ajax notifies users of alarms

Learn more about Ajax motion detectors

The detector registers alarms every 5 seconds. That is, 5 seconds is the minimum interval in which alarms can be sent to the monitoring station and Ajax apps.



The detector doesn't switch to the armed mode instantly. The time it takes to switch to the armed mode depends on two factors: delay when leaving (specified in the settings) and the "hub – detector" polling interval (in **Jeweller/Fibra** settings; the default value is 36 seconds). In the first case, the delay is set by a user or a PRO with administrator rights. In the second case, the delay occurs because the hub notifies the

detector about the transition to the armed mode not instantly, but during one polling period.

Fibra data transfer protocol

The detector uses **Fibra technology** to transmit alarms and events. This is a wired data transfer protocol that provides fast and reliable two-way communication between the hub and the connected devices. Using the bus connection method, Fibra delivers alarms and events instantly, even if 100 devices are connected to the system.

Fibra supports block encryption with a floating key and verifies each communication session with devices to prevent sabotage and spoofing. To monitor connection with the system devices and display their statuses in Ajax apps, the protocol involves regular device polling by the hub with a specified interval.

[Learn more](#)

Pet immunity

When properly installed and configured, Superior MotionProtect Fibra does not respond to pets up to 50 centimeters tall and weighing up to 20 kilograms.

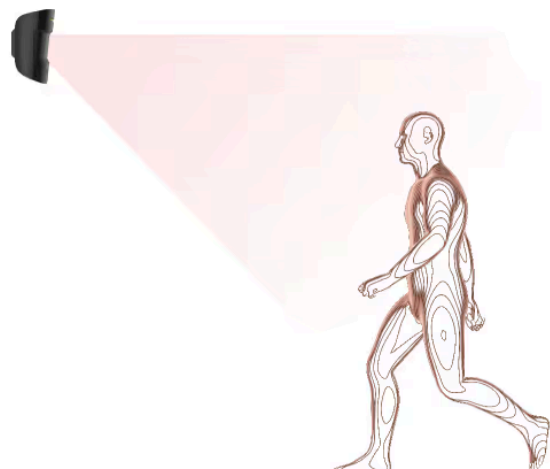
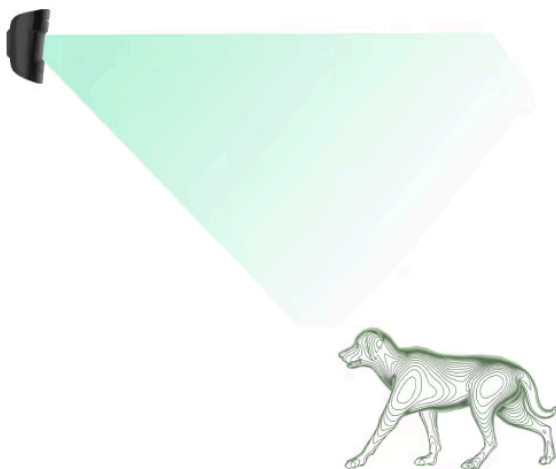

The detector is installed at a height of 2.4 meters without any obstruction to its view. For example, in a corner where the view will not be blocked by a closet or other furniture on which a pet can climb.

It is also important to set the desired sensitivity in the [detector settings](#):

- **High** – the detector does not respond to cats (up to 25 cm tall).
- **Normal** – the detector does not respond to small dogs (up to 35 cm tall).
- **Low** – the detector does not respond to pets up to 50 cm tall.

If the detector is installed below the recommended height, then the pets will move in the high sensitivity zone. If a sheepdog walks on its hind legs or even a small spaniel gets loose on a chair, the detector can raise a false alarm. The detector will also raise an alarm if the pet is able to jump to the level of the detector or move near it.

[Why motion detectors respond to pets and how to avoid this](#)

[How to install Superior MotionProtect Fibra correctly](#)

Temperature compensation

The detector perceives people and other objects as heat spots. The device monitors these heat spots and, if they move, detects an alarm. Under ideal conditions, the human body temperature (36.6°C on average) differs from the ambient temperature. Due to their contrast, the motion detector accurately captures the movement of a person in space.

In situations where the ambient temperature is very close to the body temperature, the detector may not operate properly; it may give false alarms or fail to respond to motion. To offset this factor, we use temperature compensation.

Temperature compensation is used in all Ajax motion detectors, so Superior MotionProtect Fibra detects motion over the entire operating temperature range.

[More on temperature compensation](#)

Sending events to the monitoring station

The Ajax system can transmit alarms to the [PRO Desktop](#) monitoring app as well as the Central Monitoring Station (CMS) using **SurGard (Contact ID)**, **SIA (DC-09)**, **ADEMCO 685**, and other proprietary protocols. The list of supported protocols is [available here](#).

Which CMSs can the Ajax system be connected to

Superior MotionProtect Fibra can transmit the following events:

1. Motion alarm.
2. Tamper alarm/recovery.
3. Hub connection loss/recovery.
4. Permanent deactivation/activation of the detector.
5. Unsuccessful attempt to arm the security system (with the [system integrity check](#) enabled).

When an alarm is received, the monitoring station operator of the security company knows what happened and where the Rapid Response Unit (RRU) has to be sent. Addressability of Ajax devices allows you to send not only events but also the type of the device, the name, group, and virtual room assigned to it to the PRO Desktop and to the CMS. The list of transmitted parameters may differ depending on the type of the CMS and the selected communication protocol.



The device ID, loop (zone) number, and Fibra line number can be found in [device states](#) in the Ajax app. The device number corresponds to the loop (zone) number.

Selecting the installation site

Superior MotionProtect Fibra is mounted on a vertical surface or in a corner with the bundled screws. Drill holes in the SmartBracket mount for installation. The detector is intended for indoor installation only.

When selecting a location for Superior MotionProtect Fibra, consider the parameters that affect the correct operation of the detector:



- Fibra signal strength.
- Cable length for connecting the detector to the hub.
- Motion detection zone.

Consider the placement recommendations when designing the security system project for your object. The security system should be designed and installed by professionals. The list of authorized Ajax partners is [available here](#).

Do not install the Superior MotionProtect Fibra

- Outdoors. This can lead to false alarms and detector failure.
- In places where objects and structures may obstruct the detector's view. For example, behind a flower or a column.
- In places where glass structures may obstruct the detector's view; it doesn't detect movement behind glass.
- Facing the window to avoid direct sun rays hitting the detector lens. This can lead to false alarms.
- Opposite any objects with rapidly changing temperature – for example, electric and gas heaters. This can lead to false alarms.
- Opposite any moving objects with a temperature close to that of the human body – for example, opposite the swinging curtains above a radiator. This can lead to false alarms.
- In places with fast air circulation – for example, near fans, open windows, or doors. This can lead to false alarms.
- In places with low or unstable Fibra signal strength. This may cause malfunctioning of the detector.
- Inside premises with temperature and humidity outside the permissible limits. This could damage the detector.

Fibra Signal Strength

The Fibra signal strength is determined by the ratio of the number of undelivered or corrupted data packages to those expected over a certain period of time. The icon  in the **Devices**  tab in Ajax apps indicates the signal strength:

- **Three bars** – excellent signal strength.
- **Two bars** – good signal strength.
- **One bar** – low signal strength; stable operation is not guaranteed.
- **Crossed out icon** – no signal; stable operation is not guaranteed.

The following factors affect the signal strength:

- The number of detectors connected to one Fibra line.
- Cable length and type.
- The correctness of the wire connections to the terminals.



Check the Fibra signal strength before final installation of the detector. If the signal strength is as low as one or zero bars, we cannot guarantee stable operation of the device.

Detection zone

When selecting detector placement, run a Detection Zone Test. This test allows you to check the operation of the device and accurately determine the sector in which the detector detects motion.

The location of the detector determines the area to be monitored and the effectiveness of the security system. When selecting the installation site, consider the direction of the detector lens, its viewing angles, and the presence of obstacles to the view of the lens.

The detector can recognize motion at a distance of up to 12 meters*. The direction of the detector lens should be perpendicular to the intended path of entry into the premises.

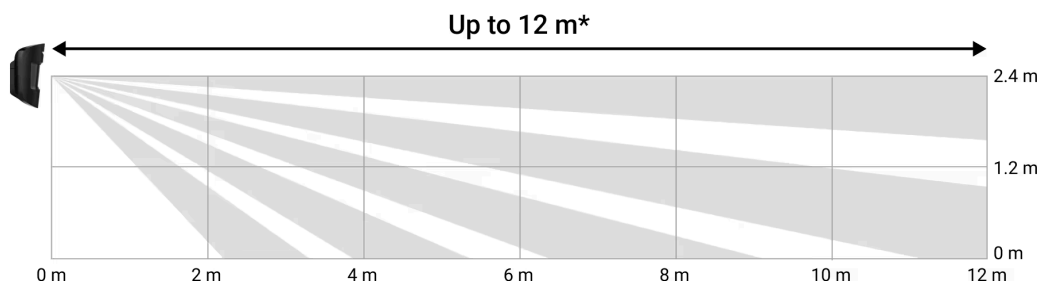

Design

To correctly install and configure security system devices, it is important to properly design the security system. The design must consider the number and types of devices at the object, their exact location and installation height, the length of wired Fibra lines, the type of cable used, and other parameters. Tips for designing Fibra wired and hybrid systems are available [in this article](#).

Topologies

Ajax security systems support two topologies: **Beam (Radial wiring)** and **Ring**.

Beam connection (Radial wiring) occupies one bus output of the hub. Only the segment that remains physically connected to the hub will function in the event of a line break. All devices connected after the breakpoint will lose connection with the hub.



Ring connection occupies two bus outputs of the hub. If the ring breaks in one place, no device will be disabled. The ring reconfigures into two lines, which continue to operate normally. Users and the security company will receive notification of the break.



Beam (Radial wiring)	Ring
<p>Occupies one bus output of the hub.</p> <p>Up to 8 beams on the same hub.</p> <p>Up to 2,000 m of wired communication for the same line.</p> <p>A terminating resistor is installed at the end of the line.</p>	<p>Occupies two bus outputs of the hub.</p> <p>Up to 4 rings on the same hub.</p> <p>Up to 500 m of wired communication for the same ring.</p> <p>No terminating resistor is installed at the end of the line.</p>

Both topologies can be used on the same hub. For example, you can use two Ring connections and four Beam (Radial) connections.

Different types of devices can be connected to the same Fibra line. For example, you can connect opening detectors, motion detectors with photo verification support, sirens, and keypads to the same line.

The devices are connected to the Fibra line one by one, as shown on the figure. Line branching is not supported.



For the **Beam (Radial)** topology, be sure to install a 120 Ohm terminating resistor at the end of the line (included in the hub complete set). The terminating resistor is connected to the signal terminals of the last detector on the line.

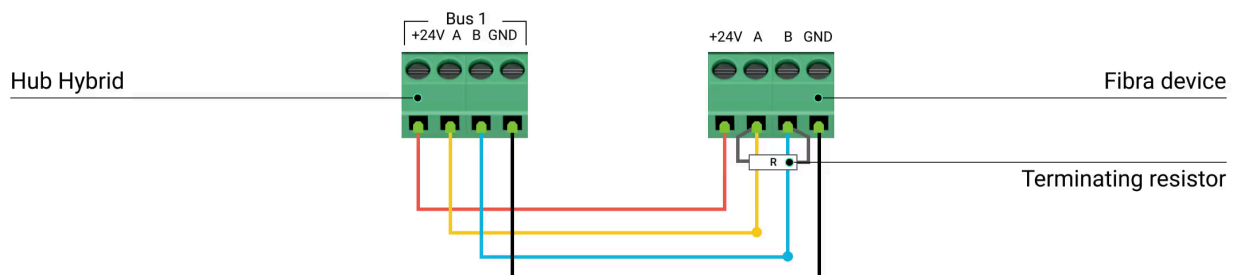

Cable length and type

The maximum communication range for wired connection using the **Beam (Radial)** topology is 2,000 meters, and that using the **Ring** topology is 500 meters.



Recommended cable types:

- U/UTP cat.5 4×2×0.51 mm (24 AWG) cable, copper conductor;
- 4×0.22 mm² signal cable, copper conductor.

If you use a different type of cable, the communication range for wired connection may vary. No other types of cables have been tested.

Verification using a calculator

To make sure that the project is calculated correctly and the system will work in practice, we have developed a [communication range calculator of Fibra lines](#). The calculator helps to check the quality of communication and cable length for wired Fibra devices with the selected configuration at the system design stage.

Additional information

The maximum current that Superior Hub Hybrid can supply in total for all Fibra lines is 600 mA. The total current consumption of the devices in the system depends on the type of cable, its length, the type of connected device, the quality of the connection of conductors, and other factors. Therefore, after selecting devices, we recommend verifying the project using the [Fibra calculator](#).

You can connect up to 100 devices to Superior Hub Hybrid by default.

Preparing for installation

Cable arrangement

When preparing to route cables, check the electrical and fire safety regulations in your region.

It is safest to route cables inside walls, floors, and ceilings; this way, they will be invisible and unavailable for intruders. It also ensures greater durability; the cable will be affected by fewer of the external factors that can impact the natural wear of the conductor and its insulating layer.

As a rule, security system cables are routed during the construction or repair stage and after wiring at the object.

If impossible to install cables inside the walls, route them so that the cable is sufficiently protected and hidden from prying eyes. For example, in a cable conduit or a protective corrugated pipe. It is recommended to hide them. For example, behind the furniture.

We recommend using protective pipes, cable conduits, or corrugated pipes to protect cables regardless of whether they are routed inside the wall or not. The cables should be arranged carefully; no sagging, tangling, or twisting is allowed.

Consider the locations of possible signal interference. If the cable is routed near motors, generators, transformers, power lines, control relays, and other sources of electromagnetic interference, use twisted-pair cable in these areas.

Cable routing

When routing cables for a security system, consider not only the general requirements and rules for electrical installation work but also the specific installation features of each device: installation height, mounting method, how the cable is inserted into the enclosure, and other parameters. Before installation, we recommend you read the [Selecting the installation site](#) section of this manual.

Avoid deviations from the security system project design. Violation of the basic installation rules and the recommendations of this manual may lead to incorrect operation of the devices.

Check the cables for bends and physical damage before routing. Replace the damaged cables.

Cables of the security system devices must be routed at a distance of at least 50 cm from the power cables when laying parallel, and, if they intersect, at a 90° angle.

Observe the permissible bend radius of the cable. It is specified by the manufacturer in the cable specifications. Otherwise, you risk damaging or breaking the conductor.

The devices are connected to the Fibra line one by one. Line branching is not supported.

Preparing cables for connection

Remove the insulating layer of the cable and strip the cable with a special insulation stripper only. It strips the cable properly without damaging the conductor. The ends of the wires that will be inserted into the detector's terminals should be tinned or crimped with end sleeves. This ensures reliable connection and protects the conductor from oxidation. Recommended cable lug sizes: 0.75 to 1 mm².

Installation and connection



Before installing Superior MotionProtect Fibra, make sure that you have selected the optimal location and that it meets the requirements of this manual. To reduce the risk of sabotage, the cables must be hidden from view and located in a place that is difficult for intruders to access. Ideally, the cables should be set into the walls, floor, or ceiling. Before final installation, run the [Detection Zone Test](#) and [Fibra Signal Strength Test](#).

When connecting to the device terminals, do not twist the wires together; solder them. The ends of the wires that will be inserted into the terminals should be tinned or crimped with special end sleeves. This will ensure a reliable connection. **Follow safety procedures and regulations for electrical installation work.**

Connection of Superior MotionProtect Fibra to the hub

1. Turn off the hub. Disconnect the external power and the hub backup battery.

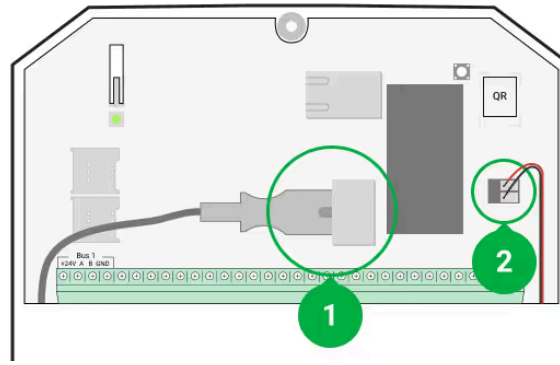

- 1 – external power supply.
- 2 – backup battery.

2. Plug the detector connection cable into the hub enclosure. Connect the wires to the required hub line.

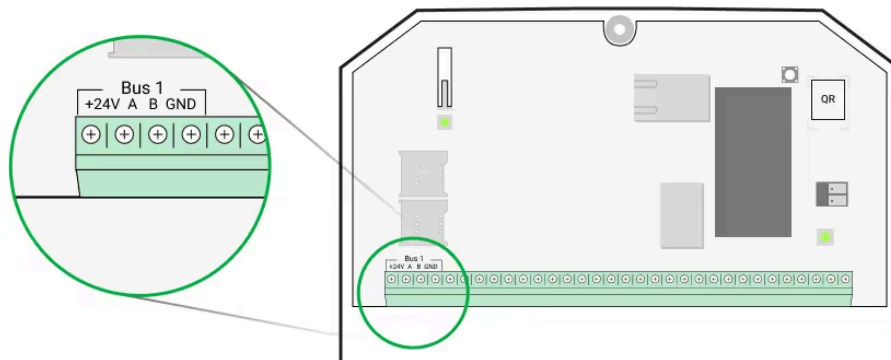

- +24V** – 24 V \equiv power terminal.
- A, B** – signal terminals.
- GND** – ground.

3. Remove the SmartBracket mounting panel and carefully break out the perforated part to output the cable from the rear side. If it is necessary to output cable from the bottom or the side, make holes in the places indicated in the figure using a drill at low speed.

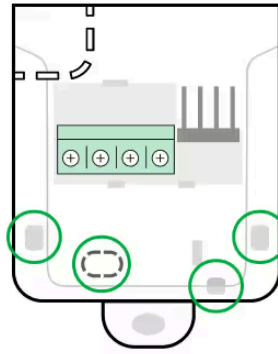

- 1 – for cable output from the rear of the detector.
- 2 – for cable output from the side.
- 3 – for cable output from the bottom.

4. If the detector is not the last device in the connection line, prepare a second cable in advance. The ends of the wires of the first and second cables that will be inserted into the terminals of the device should be tinned and soldered together.
5. Run the cable from the hub into the detector enclosure through the hole that was made.
6. Connect the wires to the terminals according to the figure below. Follow the polarity and connection order of the wires. Securely fix the cable in the terminals, and fix the cable itself with cable ties.

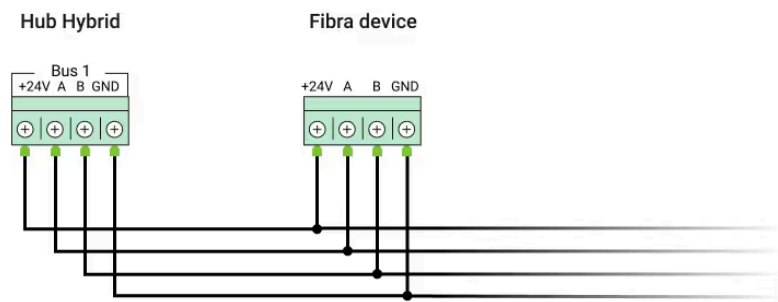

- +24V** – 24 V= power terminal.
- A, B** – signal terminals.
- GND** – ground.

7. If the detector is the last device in the line, in the case of **Beam (Radial) connection**, install a terminating resistor by connecting it to the signal terminals of

the device. When the **Ring connection** method is used, a terminating resistor is not needed.

i If possible, we recommend connecting devices using the **Ring topology** (hub – device – hub). This improves the system protection against sabotage.



8. Temporarily secure the SmartBracket mounting panel to a vertical surface or corner using double-sided adhesive tape or other temporary fasteners at the chosen installation location. This is necessary to run the detector tests. The installation height is 2.4 meters.



$h = 2.4 \text{ m}$

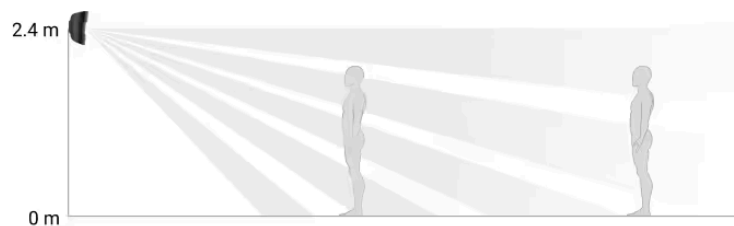

$h < 2.4 \text{ m}$

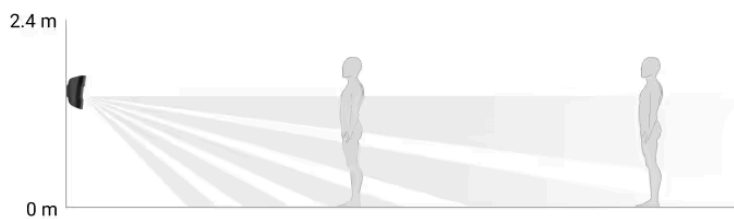

$h > 2.4 \text{ m}$



9. Place the detector on the SmartBracket mounting panel.

10. Connect the backup battery and external power supply to the hub. Turn on the hub.
11. Add Superior MotionProtect Fibra to the hub.
12. Perform the Fibra Signal Strength Test. The recommended signal strength is two or three bars. If the signal strength is one or zero bars, check the connection correctness and the cable integrity.
13. Perform the Detection Zone Test. In order to check the motion detector, walk around the premises while observing the LED and determine the detection zone of the detector. The maximum range of motion detection is 12 meters*. If the detector does not respond to motion during the test in 5 out of 5 cases, it should be installed in a different location or sensitivity should be changed.
14. If the detector passes the tests, fix the SmartBracket mounting panel with bundled screws using at least two fixing points (one of them is in the perforated part of the mount above the tamper). When using other mounts, make sure they do not damage or deform the mounting panel.



Double-sided adhesive tape can only be used for temporary attachment. The device attached by adhesive tape may come unstuck from the surface at any time. As long as the device is taped, the tamper will not be triggered when the detector is detached from the surface.

15. Put the detector on the SmartBracket mounting panel and secure it with a bundled screw.

* – for INCERT compliance 10 meters (high sensitivity)

Adding to the system



The detector is compatible only with Superior Hub Hybrid (2G) and Superior Hub Hybrid (4G). Only authorized partners can add and configure Fibra devices in Ajax PRO apps.

[Types of accounts and their rights](#)

Before adding Superior MotionProtect Fibra

1. Install an [Ajax PRO app](#).
2. Log in to a [PRO account](#) or create a new one.
3. Select a space or create a new one.

[What is a space](#)

[How to create a space](#)



The **space** functionality is available for apps of such versions or later:

- Ajax Security System 3.0 for iOS;
- Ajax Security System 3.0 for Android;
- Ajax PRO: Tool for Engineers 2.0 for iOS;
- Ajax PRO: Tool for Engineers 2.0 for Android;
- Ajax PRO Desktop 4.0 for macOS;
- Ajax PRO Desktop 4.0 for Windows.

4. Add at least one virtual room.
5. Add a [compatible hub](#) to the space. Ensure the hub is switched on and has internet access via Ethernet, Wi-Fi, and/or mobile network.
6. Ensure the space is disarmed, and the hub is not starting an update by checking statuses in the Ajax app.

How to add Superior MotionProtect Fibra

To add a detector manually

1. Open the [Ajax PRO app](#). Select the hub you want to add Superior MotionProtect Fibra to.
2. Go to the **Devices**  tab and click **Add device**.
3. Scan or enter the QR code. The QR code is located on the detector enclosure and its packaging.
4. Select a virtual room and a security group if the [Group mode](#) is enabled.
5. Press **Add**.

To have a detector added automatically

1. Open the Ajax PRO app. Select the hub you want to add Superior MotionProtect Fibra to.
2. Go to the **Devices**  tab and click **Add device**.
3. Select **Add all bus devices**. The hub will scan all Fibra lines.

After scanning, all wired devices connected to the hub will be displayed in the **Devices**  tab. The order of the devices will depend on which line they are connected to.

By default, the device name includes the detector name and its identifier. To pair the detector to the hub, edit the detector's name, and assign it a room and a group if the Group mode is enabled.

To check which detector you actually deal with, use any of the following methods: LED indication and detector triggering.

Method 1: by LED indication

In the list of available devices to add, click on any item. The LED of this device will start blinking after you press it. This way, you'll know exactly which device you're adding, how to name it, and which room and group it should be connected to.

To add a detector:

1. Select the device from the list.
2. Create a name.
3. Specify a room and a security group (if the Group mode is enabled).
4. Press **Save**. If the detector is connected to the hub successfully, it will disappear from the list of available detectors.

Method 2: by detector alarm

Enable the **Add Detectors by Alarm** option above the list of detectors.

Trigger an alarm by walking past the motion detector. When triggered, the detector will move to the top of the list in the **Triggered devices** category. The detector will stay in this category for 5 seconds, after which it will move back to the bus category.

To add a detector:

1. Select the device from the list.
2. Create a name.

3. Specify a room and a security group (if the Group mode is enabled).
4. Press **Save**. If the detector is connected to the hub successfully, it will disappear from the list of available detectors.



Device status updating depends on the Fibra settings; the default value is 36 seconds.

If you fail to add the detector, check the wire connection to the hub and try again. If the hub already has the maximum number of devices added (for Superior Hub Hybrid, the default value is 100), you will get an error notification when you add one.



Superior MotionProtect Fibra only works with one hub. When connected to a new hub, the detector stops sending commands to the old one. Once added to a new hub, Superior MotionProtect Fibra is not removed from the list of devices of the old hub. This must be done through the Ajax app.

Functionality testing

The Ajax system offers several types of tests to help you select the right installation place for the devices. Tests do not start immediately but commence no later than over a single “hub – device” polling interval.











For Superior MotionProtect Fibra, **Fibra Signal Strength Test** and **Detection Zone Test** are available. The Signal Strength Test allows you to determine the strength and stability of the signal at the installation site of the device, and the Detection Zone Test checks how the detector responds to alarms.

To run a test in the Ajax app

1. Select a hub if you have several of them or if you are using the Ajax PRO app.
2. Go to the **Devices**  tab.
3. Select Superior MotionProtect Fibra.
4. Go to the Superior MotionProtect Fibra **Settings** by clicking on the gear icon .
5. Select a test:
 - a. Fibra Signal Strength Test.
 - b. Detection Zone Test.
6. Run the test following the prompts of the app.

Icons

The icons display some of Superior MotionProtect Fibra states. You can view them in the Ajax app in the **Devices**  tab.

Icon	Meaning
	Fibra Signal Strength – displays the signal strength between the hub and the detector. Recommended value is 2–3 bars. Learn more
	The detector operates in the Always Active mode. Learn more
 	Delay When Entering and/or Leaving enabled. Learn more
	Superior MotionProtect Fibra will operate when Night Mode is enabled. Learn more
	Superior MotionProtect Fibra has detected motion. The detector identifies motion only in the armed mode.
	Superior MotionProtect Fibra has been disabled by a user or a PRO with administrator rights. Learn more
	Superior MotionProtect Fibra has been disabled due to exceeding the number of alarms. Learn more
	Superior MotionProtect Fibra tamper-triggering events are disabled. Learn more
	The device has lost connection with the hub or the hub has lost connection with the Ajax Cloud server.
	The device has not been transferred to the new hub. Learn more

States

The states include information about the device and its operating parameters. Superior MotionProtect Fibra states can be found in the Ajax app:

1. Go to the **Devices**  tab.
2. Select **Superior MotionProtect Fibra** from the list.



Parameter	Meaning
Data import	<p>Displays the error when transferring data to the new hub:</p> <ul style="list-style-type: none"> • Failed – the device has not been transferred to the new hub. <p>Learn more</p>
Temperature	<p>Detector temperature. Measured on the processor and changes gradually.</p> <p>Acceptable error between the value in the app and the room temperature – 2°C.</p> <p>The value is updated as soon as the detector identifies a temperature change of at least 2°C.</p> <p>You can configure a scenario by temperature to control automation devices</p> <p>Learn more</p>
Fibra Signal Strength	<p>Signal strength between the hub and Superior MotionProtect Fibra. Recommended value is 2–3 bars.</p> <p>Fibra is a protocol for transmitting Fibra devices events and alarms.</p> <p>Learn more</p>
Connection via Fibra	<p>The status of connection between the hub and the detector:</p> <ul style="list-style-type: none"> • Online – the detector is connected to the hub. • Offline – the detector has lost connection with the hub.
Bus Voltage	Detector voltage value on the Fibra line.
Lid	<p>The status of the detector tamper that responds to detachment or opening of the device enclosure:</p> <ul style="list-style-type: none"> • Open – the detector is removed from the mount. Check the mounting of the detector. • Closed – the detector is installed on the mount. Normal state. <p>Learn more</p>
Sensitivity	<p>Sensitivity level of the motion detector:</p> <ul style="list-style-type: none"> • Low – the detector does not respond to pets up to 50 cm tall.

	<ul style="list-style-type: none"> • Normal (by default) – the detector does not respond to small dogs (up to 35 cm tall). • High – the detector does not respond to cats (up to 25 cm tall).
Always Active	<p>If active, the detector is always in armed mode and detects motion.</p> <p>Learn more</p>
Permanent Deactivation	<p>Shows the status of the device permanent deactivation function:</p> <ul style="list-style-type: none"> • No – the device operates in normal mode and transmits all events. • Lid only – the hub administrator has disabled notifications about tamper triggering. • Entirely – the hub administrator has entirely excluded the detector from the system. The device does not follow system commands and does not report alarms or other events. • By number of alarms – the device is automatically disabled when the number of alarms is exceeded (the number is specified in the Devices Auto Deactivation settings). <p>Learn more</p>
Alarm Reaction	
Operating Mode	<p>Shows how the detector reacts to alarms:</p> <ul style="list-style-type: none"> • Instant Alarm – the armed detector immediately reacts to a threat and raises the alarm. • Entry/Exit – when a delay is set, the armed device starts the countdown and doesn't raise the alarm even if triggered until the countdown ends. • Follower – the detector inherits the delays from Entry/Exit detectors. However, when the Follower is triggered individually, it immediately raises the alarm.
Delay When Entering, sec	<p>Delay time when entering: 5 to 120 seconds.</p> <p>Delay when entering (alarm activation delay) is the time the user has to disarm the security system after entering the secured area.</p> <p>Learn more</p>
Delay When Leaving, sec	<p>Delay time when leaving: 5 to 120 seconds.</p> <p>Delay when leaving (arming delay) is the time the user has to leave the secured area after arming.</p> <p>Learn more</p>
Night Mode Delay When Entering, sec	<p>Delay time when entering in Night Mode: 5 to 120 seconds.</p> <p>Delay when entering (alarm activation delay) is the time the user has to disable Night Mode after entering the premises.</p>

	<u>What is Delay When Entering</u>
Night Mode Delay When Leaving, sec	<p>Delay time when leaving in Night Mode: 5 to 120 seconds.</p> <p>Delay when leaving (arming delay) is the time the user has to leave the premises after enabling Night Mode.</p> <p><u>What is Delay When Leaving</u></p>
Firmware	Detector firmware version.
Device ID	Detector ID. Also available on the QR code on the detector enclosure and the packaging.
Device No.	Device number. This number is transmitted to the CMS in case of an alarm or event.
Bus No.	The number of the Fibra line the device is connected to.

Settings

To change the detector settings in the Ajax app:

1. Go to the **Devices**  tab.
2. Select **Superior MotionProtect Fibra** from the list.
3. Go to **Settings** by clicking on the gear icon .
4. Set the required settings.
5. Click **Back** to save the new settings.



An Ajax system enables PROs to apply multiple preconfigured settings to a group of devices simultaneously via setting templates.

[Learn more about settings templates](#)

Settings	Meaning
Name	<p>Detector name. Displayed in the list of hub devices, text of SMS and notifications in the events feed.</p> <p>To change the detector name, click on the text field.</p> <p>The name can contain up to 12 Cyrillic characters or up to 24 Latin characters.</p>

Room	<p>Selecting the virtual room to which Superior MotionProtect Fibra is assigned.</p> <p>The room name is displayed in the text of SMS and notifications in the events feed.</p> <p>Learn more</p>
Alarm LED indication	<p>When off, the detector's LED will not alert you about an alarm and tamper triggering.</p>
Sensitivity	<p>Sensitivity level of the motion detector.</p> <p>The selection depends on the type of the object, the presence of probable sources of false alarms, and the type of the protected area:</p> <ul style="list-style-type: none"> • Low – the detector does not respond to pets up to 50 cm tall. • Normal (by default) – the detector does not respond to small dogs (up to 35 cm tall). • High – the detector does not respond to cats (up to 25 cm tall). <p>Why motion detectors respond to pets and how to avoid this</p>
Always Active	<p>If active, the detector is always in armed mode and detects motion.</p> <p>Learn more</p>
Alert with a siren if motion detected	<p>When this option is enabled, sirens connected to the system are activated when motion is detected by the Superior MotionProtect Fibra detector.</p>
Alarm Reaction	
Operating Mode	<p>Specify how this device will react to alarms:</p> <ul style="list-style-type: none"> • Instant Alarm – the armed detector immediately reacts to a threat and raises the alarm. • Entry/Exit – when a delay is set, the armed device starts the countdown and doesn't raise the alarm even if triggered until the countdown ends. • Follower – the detector inherits the delays from Entry/Exit detectors. However, when the Follower is triggered individually, it immediately raises the alarm.
Delay When Entering, sec	<p>Selecting delay time when entering: 5 to 120 seconds.</p> <p>Delay when entering (alarm activation delay) is the time the user has to disarm the security system after entering the premises.</p> <p>What is Delay When Entering</p>
Delay When Leaving, sec	<p>Selecting delay time when leaving: 5 to 120 seconds.</p> <p>Delay when leaving (arming delay) is the time the user has to leave the premises after arming.</p>

	<p>What is Delay When Leaving</p>
Arm in Night Mode	<p>When this option is enabled, the detector will enter the armed mode when the system is set to Night Mode.</p> <p>What is Night Mode</p>
Night Mode Delay When Entering, sec	<p>Delay time when entering in Night Mode: 5 to 120 seconds.</p> <p>Delay when entering (alarm activation delay) is the time the user has to disable Night Mode after entering the premises.</p> <p>What is Delay When Entering</p>
Night Mode Delay When Leaving, sec	<p>Delay time when leaving in Night Mode: 5 to 120 seconds.</p> <p>Delay when leaving (arming delay) is the time the user has to leave the premises after enabling Night Mode.</p> <p>What is Delay When Leaving</p>
Fibra Signal Strength Test	<p>Switches the detector to the Fibra signal strength testing mode.</p> <p>The test allows you to check the signal strength between the hub and the detector over the Fibra wired data transfer protocol to determine the optimal installation location.</p> <p>Learn more</p>
Detection Zone Test	<p>Switches the detector to the detection zone testing mode.</p> <p>The test allows the user to check the detector’s response to the motion and determine the optimal installation location.</p> <p>Learn more</p>
User Guide	<p>Opens Superior MotionProtect Fibra User Manual in the Ajax app.</p>
Permanent Deactivation	<p>Allows the user to disconnect the device without removing it from the system. There are three options:</p> <ul style="list-style-type: none"> • Entirely – the device will not execute commands or participate in automation scenarios. The system will ignore device alarms and other notifications. • Lid only – the system will ignore notifications about the triggering of the device tamper only. • No – the detector operates in normal mode. <p>Learn more</p> <p>The system can also automatically deactivate devices when the set number of alarms is exceeded.</p> <p>Learn more</p>

Unpair Device	Unpairs the detector, disconnects it from the hub, and deletes its settings.
---------------	--

LED indication

LED indication	Event	Note
When power is connected, it lights up green once.	The detector is on.	
Lights up green for about 1 second.	Motion alarm / tamper triggering.	The detector records motion once every 5 seconds.
Smoothly lights up and goes out after an alarm or tamper triggering.	Low Fibra line (bus) voltage.	Voltage of 7 V _{DC} or less is considered low.

Malfunctions

If a hub identifies a detector malfunction (for example, there is no connection with the hub via Fibra protocol), the Ajax app will display a malfunction counter in the upper left corner of the device icon.

All malfunctions can be seen in the detector states. Fields with malfunctions will be highlighted in red.

Malfunction is displayed if:

- The detector temperature is outside acceptable limits.
- The detector enclosure is open (tamper is triggered).
- There is no signal via Fibra protocol.

Maintenance

Check the functioning of the detector on a regular basis. The optimal frequency of checks is once every three months. Clean the detector enclosure of dust, cobwebs and other contaminants as they emerge. Use a soft dry cloth suitable for equipment care.

Do not use substances that contain alcohol, acetone, gasoline, and other active solvents to clean the detector. Wipe the lens gently as scratches may impair the detector sensitivity.

Technical specifications

All technical specifications of Superior MotionProtect Fibra

Compliance with standards

Complete set

1. Superior MotionProtect Fibra.
2. SmartBracket mounting panel.
3. Installation kit.
4. Quick start guide.

Warranty

Warranty for the Limited Liability Company "Ajax Systems Manufacturing" products is valid for 2 years after the purchase.

If the device does not function correctly, please contact Ajax Technical Support first. In most cases, technical issues can be resolved remotely.

Warranty obligations

User Agreement

Contact Technical Support:

- e-mail
- Telegram

Manufactured by "AS Manufacturing" LLC



Need help?

In this section you'll find detailed manuals and educational videos about all features of Ajax. And in case you need help of a technical specialist, we're available 24/7.

[Send request](#)

Subscribe

Subscribe to our emails about secure life. No spam.

[Subscribe](#)

Request extra help

+447451279411

support@ajax.systems

@AjaxSystemsSupport_Bot

Send a request



Rating 4.8

4,500,000

people worldwide under Ajax protection

Suggest a feature



Products

- Intrusion protection
- Video surveillance
- Fire and life safety
- Comfort and automation
- All products
- Services
- System integrations
- Ajax Ready products
- Fibra wired protocol
- Ajax radio protocols

Solutions

- Customer stories
- Solutions by facility type
- Commercial fire detection and alarm system
- Wireless Grade 3 solution
- Video surveillance solution

Software

- Ajax Security System
- Ajax PRO: Tool for Engineers
- Ajax Desktop
- Ajax PRO Desktop
- Ajax TV
- Ajax Translator PRO
- Ajax Cloud Signaling
- Ajax Media Player
- Scenarios

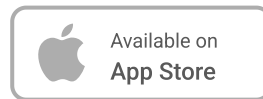

Support

- Manuals and articles
- Compliance with standards

Tools

- Ajax kit configurator

[Integration with Yale smart locks](#)

[Ajax device compatibility](#)

[Upgrades and retrofits](#)

[CMS software compatibility](#)

[Why Ajax](#)

[Ajax Services availability](#)

[How it works](#)

[Video storage calculator](#)

[Video device calculator](#)

[Battery life calculator](#)

[Radio communication range calculator](#)

[Switches and outlets configurator](#)

[Fibra power supply calculator](#)

[All web tools](#)

Monitoring solutions and integrations

[Intrusion alarm monitoring](#)

[Video monitoring and visual alarm verification](#)

[Audio alarm verification](#)

Company

[Blog](#)

[About us](#)

[Press page](#)

[Events](#)

[Career](#)

[Ajax Next](#)

[Reviews and feedback](#)

For partners

[For partners](#)

[Ajax Academy](#)

[Partner Portal](#)

[Ajax PRO channel](#)

[🇬🇧 United Kingdom](#) [Privacy policy](#) [Report a vulnerability](#) [GDPR White Paper](#) [NDAA Statement](#) [Cookie policy](#)

[Anti-Spam Policy](#) [Ajax Services T&C](#) [End user agreement](#) [Warranty](#)

© 2026 AJAX SYSTEMS CH. All rights reserved