



# **DS-K1T673 Series Face Recognition Terminal**

**User Manual**

## Regulatory Information

### FCC Information

Please take attention that changes or modification not expressly approved by the party responsible for compliance could void the user's authority to operate the equipment.

FCC compliance: This equipment has been tested and found to comply with the limits for a Class B digital device, pursuant to part 15 of the FCC Rules. These limits are designed to provide reasonable protection against harmful interference in a residential installation. This equipment generates, uses and can radiate radio frequency energy and, if not installed and used in accordance with the instructions, may cause harmful interference to radio communications. However, there is no guarantee that interference will not occur in a particular installation. If this equipment does cause harmful interference to radio or television reception, which can be determined by turning the equipment off and on, the user is encouraged to try to correct the interference by one or more of the following measures:

- Reorient or relocate the receiving antenna.
- Increase the separation between the equipment and receiver.
- Connect the equipment into an outlet on a circuit different from that to which the receiver is connected.
- Consult the dealer or an experienced radio/TV technician for help

This equipment should be installed and operated with a minimum distance 20cm between the radiator and your body.

#### FCC Conditions

This device complies with part 15 of the FCC Rules. Operation is subject to the following two conditions:

1. This device may not cause harmful interference.
2. This device must accept any interference received, including interference that may cause undesired operation.

### EU Conformity Statement



This product and - if applicable - the supplied accessories too are marked with "CE" and comply therefore with the applicable harmonized European standards listed

under the EMC Directive 2014/30/EU, RE Directive 2014/53/EU, the RoHS Directive 2011/65/EU



2012/19/EU (WEEE directive): Products marked with this symbol cannot be disposed of as unsorted municipal waste in the European Union. For proper recycling, return this product to your local supplier upon the purchase of equivalent new equipment, or dispose of it at designated collection points. For more information see: [www.recyclethis.info](http://www.recyclethis.info)



2006/66/EC (battery directive): This product contains a battery that cannot be disposed of as unsorted municipal waste in the European Union. See the product documentation for specific battery information. The battery is marked with this symbol, which may include lettering to indicate cadmium (Cd), lead (Pb), or mercury (Hg). For proper recycling, return the battery to your supplier or to a designated collection point. For more information see: [www.recyclethis.info](http://www.recyclethis.info)



## Safety Instruction

These instructions are intended to ensure that user can use the product correctly to avoid danger or property loss.

The precaution measure is divided into Dangers and Cautions:

**Dangers:** Neglecting any of the warnings may cause serious injury or death.

**Cautions:** Neglecting any of the cautions may cause injury or equipment damage.

	
<b>Dangers:</b> Follow these safeguards to prevent serious injury or death.	<b>Cautions:</b> Follow these precautions to prevent potential injury or material damage.

 **Danger:**

- All the electronic operation should be strictly compliance with the electrical safety regulations, fire prevention regulations and other related regulations in your local region.
- Please use the power adapter, which is provided by normal company. This equipment is intended to be supplied from the Class 2 surge protected power source rated DC 12V, 3A.
- Do not connect several devices to one power adapter as adapter overload may cause over-heat or fire hazard.
- Please make sure that the power has been disconnected before you wire, install or dismantle the device.
- When the product is installed on wall or ceiling, the device shall be firmly fixed.
- If smoke, odors or noise rise from the device, turn off the power at once and unplug the power cable, and then please contact the service center.
- Do not ingest battery, Chemical Burn Hazard.  
This product contains a coin/button cell battery. If the coin/button cell battery is swallowed, it can cause severe internal burns in just 2 hours and can lead to death.  
Keep new and used batteries away from children. If the battery compartment does not close securely, stop using the product and keep it away from children. If you think batteries might have been swallowed or placed inside any part of the body, seek immediate medical attention.
- If the product does not work properly, please contact your dealer or the nearest service center. Never attempt to disassemble the device yourself. (We shall not assume any responsibility for problems caused by unauthorized repair or maintenance.)

### **Cautions:**

- Do not drop the device or subject it to physical shock, and do not expose it to high electromagnetism radiation. Avoid the equipment installation on vibrations surface or places subject to shock (ignorance can cause equipment damage).
- Do not place the device in extremely hot (refer to the specification of the device for the detailed operating temperature), cold, dusty or damp locations, and do not expose it to high electromagnetic radiation.
- The device cover for indoor use shall be kept from rain and moisture.
- Exposing the equipment to direct sun light, low ventilation or heat source such as heater or radiator is forbidden (ignorance can cause fire danger).
- Do not aim the device at the sun or extra bright places. A blooming or smear may occur otherwise (which is not a malfunction however), and affecting the endurance of sensor at the same time.
- Please use the provided glove when open up the device cover, avoid direct contact with the device cover, because the acidic sweat of the fingers may erode the surface coating of the device cover.
- Please use a soft and dry cloth when clean inside and outside surfaces of the device cover, do not use alkaline detergents.
- Please keep all wrappers after unpack them for future use. In case of any failure occurred, you need to return the device to the factory with the original wrapper. Transportation without the original wrapper may result in damage on the device and lead to additional costs.
- Improper use or replacement of the battery may result in hazard of explosion. Replace with the same or equivalent type only. Dispose of used batteries according to the instructions provided by the battery manufacturer.
- Biometric recognition products are not completely applicable to anti-spoofing environments. If you require a higher security level, use multiple authentication modes.
- Working temperature: -30 °C to +60 °C
- Indoor and outdoor use. If installing the device indoors, the device should be at least 2 meters away from the light, and at least 3 meters away from the window or the door. If installing the device outdoors, you should apply Silicone sealant among the cable wiring area to keep the raindrop from entering.
- Protection level: IP65

## Available Models

Product Name	Model
Face Recognition Terminal	DS-K1T673DX
	DS-K1T673DWX
	DS-K1T673TDX
	DS-K1T673TDWX
	DS-K1T673TDGX
	DS-K1T673TMW
	DS-K1T673TMG

Use only power supplies listed in the user instructions:

Model	Manufacturer	Standard
C2000IC12.0-24P-DE	MOSO Power Supply Technology Co., Ltd.	CEE
C2000IC12.0-24P-GB	MOSO Power Supply Technology Co., Ltd.	BS
KPL-040F-VI	Channel Well Technology Co Ltd.	CEE

## Legal Information

### About this Document

- This Document includes instructions for using and managing the Product. Pictures, charts, images and all other information hereinafter are for description and explanation only.
- The information contained in the Document is subject to change, without notice, due to firmware updates or other reasons. Please find the latest version of the Document at the Hikvision website ( <https://www.hikvision.com> ). Unless otherwise agreed, Hangzhou Hikvision Digital Technology Co., Ltd. or its affiliates (hereinafter referred to as "Hikvision") makes no warranties, express or implied.
- Please use the Document with the guidance and assistance of professionals trained in supporting the Product.

### About this Product

- This product can only enjoy the after-sales service support in the country or region where the purchase is made.
- If the product you choose is a video product, please scan the following QR code to obtain the "Initiatives on the Use of Video Products", and read it carefully.



### Acknowledgment of Intellectual Property Rights

- Hikvision owns the copyrights and/or patents related to the technology embodied in the Products described in this Document, which may include licenses obtained from third parties.
- Any part of the Document, including text, pictures, graphics, etc., belongs to Hikvision. No part of this Document may be excerpted, copied, translated, or modified in whole or in part by any means without written permission.
- **HIKVISION** and other Hikvision's trademarks and logos are the properties of Hikvision in various jurisdictions.
- Other trademarks and logos mentioned are the properties of their respective owners.

### LEGAL DISCLAIMER

- TO THE MAXIMUM EXTENT PERMITTED BY APPLICABLE LAW, THIS DOCUMENT AND THE PRODUCT DESCRIBED, WITH ITS HARDWARE, SOFTWARE AND FIRMWARE, ARE PROVIDED "AS IS" AND "WITH ALL FAULTS AND ERRORS". HIKVISION MAKES NO WARRANTIES, EXPRESS OR

IMPLIED, INCLUDING WITHOUT LIMITATION, MERCHANTABILITY, SATISFACTORY QUALITY, OR FITNESS FOR A PARTICULAR PURPOSE. THE USE OF THE PRODUCT BY YOU IS AT YOUR OWN RISK. IN NO EVENT WILL HIKVISION BE LIABLE TO YOU FOR ANY SPECIAL, CONSEQUENTIAL, INCIDENTAL, OR INDIRECT DAMAGES, INCLUDING, AMONG OTHERS, DAMAGES FOR LOSS OF BUSINESS PROFITS, BUSINESS INTERRUPTION, OR LOSS OF DATA, CORRUPTION OF SYSTEMS, OR LOSS OF DOCUMENTATION, WHETHER BASED ON BREACH OF CONTRACT, TORT (INCLUDING NEGLIGENCE), PRODUCT LIABILITY, OR OTHERWISE, IN CONNECTION WITH THE USE OF THE PRODUCT, EVEN IF HIKVISION HAS BEEN ADVISED OF THE POSSIBILITY OF SUCH DAMAGES OR LOSS.

- YOU ACKNOWLEDGE THAT THE NATURE OF THE INTERNET PROVIDES FOR INHERENT SECURITY RISKS, AND HIKVISION SHALL NOT TAKE ANY RESPONSIBILITIES FOR ABNORMAL OPERATION, PRIVACY LEAKAGE OR OTHER DAMAGES RESULTING FROM CYBER-ATTACK, HACKER ATTACK, VIRUS INFECTION, OR OTHER INTERNET SECURITY RISKS; HOWEVER, HIKVISION WILL PROVIDE TIMELY TECHNICAL SUPPORT IF REQUIRED.
- YOU AGREE TO USE THIS PRODUCT IN COMPLIANCE WITH ALL APPLICABLE LAWS, AND YOU ARE SOLELY RESPONSIBLE FOR ENSURING THAT YOUR USE CONFORMS TO THE APPLICABLE LAW. ESPECIALLY, YOU ARE RESPONSIBLE, FOR USING THIS PRODUCT IN A MANNER THAT DOES NOT INFRINGE ON THE RIGHTS OF THIRD PARTIES, INCLUDING WITHOUT LIMITATION, RIGHTS OF PUBLICITY, INTELLECTUAL PROPERTY RIGHTS, OR DATA PROTECTION AND OTHER PRIVACY RIGHTS. YOU SHALL NOT USE THIS PRODUCT FOR ANY PROHIBITED END-USES, INCLUDING THE DEVELOPMENT OR PRODUCTION OF WEAPONS OF MASS DESTRUCTION, THE DEVELOPMENT OR PRODUCTION OF CHEMICAL OR BIOLOGICAL WEAPONS, ANY ACTIVITIES IN THE CONTEXT RELATED TO ANY NUCLEAR EXPLOSIVE OR UNSAFE NUCLEAR FUEL-CYCLE, OR IN SUPPORT OF HUMAN RIGHTS ABUSES.
- IN THE EVENT OF ANY CONFLICTS BETWEEN THIS DOCUMENT AND THE APPLICABLE LAW, THE LATTER PREVAILS.

### **Data Protection**



- To protect data, the development of Hikvision Products incorporates privacy by design principles. For example, for Products with facial recognition features, biometrics data is stored in your Products with encryption method; for fingerprint Products, only fingerprint template will be saved, which is impossible to reconstruct a fingerprint image.
- As a data controller/processor, you may process personal data, including collection, storage, use, processing, disclosure, deletion, etc. You are advised to pay attention to and comply with applicable laws and regulations related to the protection of personal data, including without limitation, conducting security controls to safeguard personal data, such as, implementing reasonable administrative and physical security controls, conduct periodic reviews and the assessments of the effectiveness of your security controls.

**© Hangzhou Hikvision Digital Technology Co., Ltd. All rights reserved.**



## Symbol Conventions

The symbols that may be found in this document are defined as follows.

Symbol	Description
 <b>Danger</b>	Indicates a hazardous situation which, if not avoided, will or could result in death or serious injury.
 <b>Caution</b>	Indicates a potentially hazardous situation which, if not avoided, could result in equipment damage, data loss, performance degradation, or unexpected results.
 <b>Note</b>	Provides additional information to emphasize or supplement important points of the main text.

# Contents

<b>Chapter 1 Appearance</b> .....	<b>1</b>
<b>Chapter 2 Installation</b> .....	<b>3</b>
2.1 Installation Environment .....	3
2.2 Flush Mounting with Gang Box .....	3
2.3 Surface Mounting .....	7
2.4 Mount With Bracket .....	11
2.4.1 Preparation before Mounting with Bracket .....	11
2.4.2 Mount Bracket .....	13
<b>Chapter 3 Wiring</b> .....	<b>16</b>
3.1 Terminal Description .....	16
3.2 Wire Normal Device .....	18
3.3 Wire Secure Door Control Unit .....	19
3.4 Wire Fire Module .....	20
3.4.1 Wiring Diagram of Door Open When Powering Off .....	20
3.4.2 Wiring Diagram of Door Locked When Powering Off .....	22
<b>Chapter 4 Palm Print and Palm Vein Indicator Description</b> .....	<b>25</b>
<b>Chapter 5 Activation</b> .....	<b>26</b>
5.1 Activate via Device .....	26
5.2 Activate via Web Browser .....	28
5.3 Activate via SADP .....	29
5.4 Activate Device via iVMS-4200 Client Software .....	30
<b>Chapter 6 Quick Operation</b> .....	<b>32</b>
6.1 Select Language .....	32
6.2 Set Password Change Type .....	34
6.3 Set Network Parameters .....	34
6.4 Access to Platform .....	36

6.5 Privacy Settings .....	38
6.6 Set Administrator .....	38
6.7 Authentication Page Instructions .....	39
<b>Chapter 7 Basic Operation .....</b>	<b>41</b>
7.1 Login .....	41
7.1.1 Login by Administrator .....	41
7.1.2 Login by Activation Password .....	44
7.1.3 Forgot Password .....	45
7.1.4 Change Device Password .....	46
7.2 Communication Settings .....	47
7.2.1 Set Wired Network Parameters .....	47
7.2.2 Set Wi-Fi Parameters .....	49
7.2.3 Set RS-485 Parameters .....	51
7.2.4 Set Wiegand Parameters .....	52
7.2.5 Set ISUP Parameters .....	52
7.2.6 Platform Access .....	54
7.3 Person Management .....	54
7.3.1 Add Administrator .....	55
7.3.2 Import and Export Face and Person Data in Batch via Device .....	56
7.3.3 Add Face Picture .....	58
7.3.4 Add Card .....	61
7.3.5 Add Fingerprint .....	62
7.3.6 View PIN code .....	63
7.3.7 Add Keyfob .....	63
7.3.8 Add Palm Print and Palm Vein .....	64
7.3.9 Set Person Type via Device .....	65
7.3.10 Set Authentication Mode .....	67
7.3.11 Search and Edit Person .....	67

7.3.12 Set Person Door Permission via Device .....	68
7.4 Data Management .....	70
7.4.1 Delete Data .....	70
7.4.2 Import Data .....	70
7.4.3 Export Data .....	71
7.5 Person Authentication .....	72
7.5.1 Authenticate via Single Credential .....	72
7.5.2 Authenticate via Multiple Credential .....	72
7.6 Basic Settings .....	73
7.6.1 Enable/Disable Voice Prompt via Device .....	74
7.6.2 Set Device Time via Device .....	75
7.6.3 Set Sleep Duration via Device .....	75
7.6.4 Select Language .....	75
7.6.5 Set Device Number via Device .....	75
7.6.6 Set Beauty via Device .....	75
7.6.7 Set Privacy Parameters via Device .....	76
7.6.8 Set Video Standard .....	76
7.6.9 Set Secure Door Control Unit Parameters .....	77
7.7 Set Face Parameters .....	77
7.7.1 Set Face Liveness Level via Device .....	78
7.7.2 Set Recognition Distance via Device .....	79
7.7.3 Set Face Recognition Interval via Device .....	79
7.7.4 Set Face 1:N Security Level via Device .....	79
7.7.5 Set Face 1:1 Security Level via Device .....	79
7.7.6 Enable/Disable ECO Mode via Device .....	80
7.7.7 Enable/Disable Hard Hat Detection via Device .....	80
7.7.8 Enable/Disable Mask Detection via Device .....	81
7.7.9 Enable/Disable Multi-Faces Recognition .....	82

7.7.10 Face Duplicate Check via Device .....	82
7.7.11 Set Palm Print .....	82
7.8 Access Control Settings .....	83
7.8.1 Set Terminal Authentication Mode via Device .....	83
7.8.2 Set Reader Authentication Mode via Device .....	84
7.8.3 Manually Trigger Face Authentication via PC Web .....	84
7.8.4 Enable/Disable NFC Card .....	85
7.8.5 Enable/Disable M1 Card .....	85
7.8.6 Remote Authentication .....	85
7.8.7 Set Authentication Interval via Device .....	86
7.8.8 Set Authentication Result Display Duration via Device .....	86
7.8.9 Set Password Mode .....	86
7.8.10 Door Parameter Configuration .....	86
7.9 Platform Attendance .....	87
7.9.1 Disable Attendance Mode via Device .....	87
7.9.2 Set Manual Attendance via Device .....	88
7.9.3 Set Auto Attendance via Device .....	89
7.9.4 Set Manual and Auto Attendance via Device .....	91
7.10 Preference Settings .....	92
7.10.1 Set Shortcut Key via Device .....	93
7.10.2 Theme .....	94
7.11 System Maintenance .....	95
7.11.1 View System Information .....	95
7.11.2 View Device Capacity via Device .....	96
7.11.3 Upgrade .....	96
7.11.4 Restore Settings .....	97
7.12 Video Intercom .....	97
7.12.1 Call Client Software from Device .....	97

7.12.2 Call Center from Device .....	98
7.12.3 Call Device from Client Software .....	99
7.12.4 Call Room from Device .....	99
7.12.5 Call Mobile Client from Device .....	100
<b>Chapter 8 Operation via Web Browser .....</b>	<b>101</b>
8.1 Login .....	101
8.2 Forget Password .....	101
8.3 Download Web Plug-In .....	101
8.4 Help .....	102
8.4.1 Open Source Software Licenses .....	102
8.4.2 View Online Help Document .....	102
8.5 Logout .....	102
8.6 Quick Operation via Web Browser .....	102
8.6.1 Change Password .....	102
8.6.2 Select Language .....	103
8.6.3 Time Settings .....	103
8.6.4 Environment Settings .....	104
8.6.5 Privacy Settings .....	104
8.6.6 Administrator Settings .....	105
8.6.7 No. and System Network .....	106
8.7 Person Management .....	107
8.8 Access Control Management .....	110
8.8.1 Overview .....	110
8.8.2 Search Event .....	111
8.8.3 Door Parameter Configuration .....	111
8.8.4 Authentication Settings .....	114
8.8.5 Set Face Parameters .....	119
8.8.6 Card Settings .....	125

8.8.7 Elevator Control via Web .....	127
8.8.8 Linkage Settings .....	128
8.8.9 Set Working Mode via PC Web .....	129
8.8.10 Set Remote Verification .....	129
8.8.11 Privacy Settings .....	129
8.8.12 Call Settings .....	132
8.9 System Configuration .....	136
8.9.1 View Device Information via PC Web .....	136
8.9.2 Set Time .....	136
8.9.3 Change Administrator's Password .....	137
8.9.4 Account Security Settings via PC Web .....	137
8.9.5 View Device Arming/Disarming Information via PC Web .....	138
8.9.6 Network Settings .....	138
8.9.7 Set Video and Audio Parameters via PC Web .....	145
8.9.8 Image Parameter Settings .....	146
8.9.9 Alarm Settings via PC Web .....	148
8.9.10 Access Configuration .....	149
8.9.11 Time and Attendance Settings .....	151
8.10 Preference Settings .....	154
8.10.1 Set Startup Image via PC Web .....	154
8.10.2 Set Standby Image via PC Web .....	155
8.10.3 Set Sleep Time via PC Web .....	155
8.10.4 Customize Authentication Desk via PC Web .....	156
8.10.5 Set Notice Publication via PC Web .....	157
8.10.6 Set Prompt Schedule via PC Web .....	158
8.10.7 Customize Prompt Voice via PC Web .....	159
8.10.8 Set Authentication Result Text via PC Web .....	160
8.11 System and Maintenance .....	160

8.11.1 Reboot .....	160
8.11.2 Upgrade .....	160
8.11.3 Restoration .....	161
8.11.4 Export Device Parameters via PC Web .....	161
8.11.5 Import Device Parameters via PC Web .....	162
8.11.6 Device Debugging .....	162
8.11.7 View Log via PC Web .....	165
8.11.8 Advanced Settings via PC Web .....	165
8.11.9 Security Management .....	165
8.11.10 Certificate Management .....	166
<b>Chapter 9 Other Platforms to Configure .....</b>	<b>168</b>
<b>Appendix A. Tips for Scanning Fingerprint .....</b>	<b>169</b>
<b>Appendix B. Tips When Collecting/Comparing Face Picture .....</b>	<b>171</b>
<b>Appendix C. Tips for Adding Palm Print and Palm Vein .....</b>	<b>173</b>
<b>Appendix D. Tips for Installation Environment .....</b>	<b>174</b>
<b>Appendix E. Dimension .....</b>	<b>175</b>



## Chapter 1 Appearance

Refer to the following contents for detailed information of the face recognition terminal:

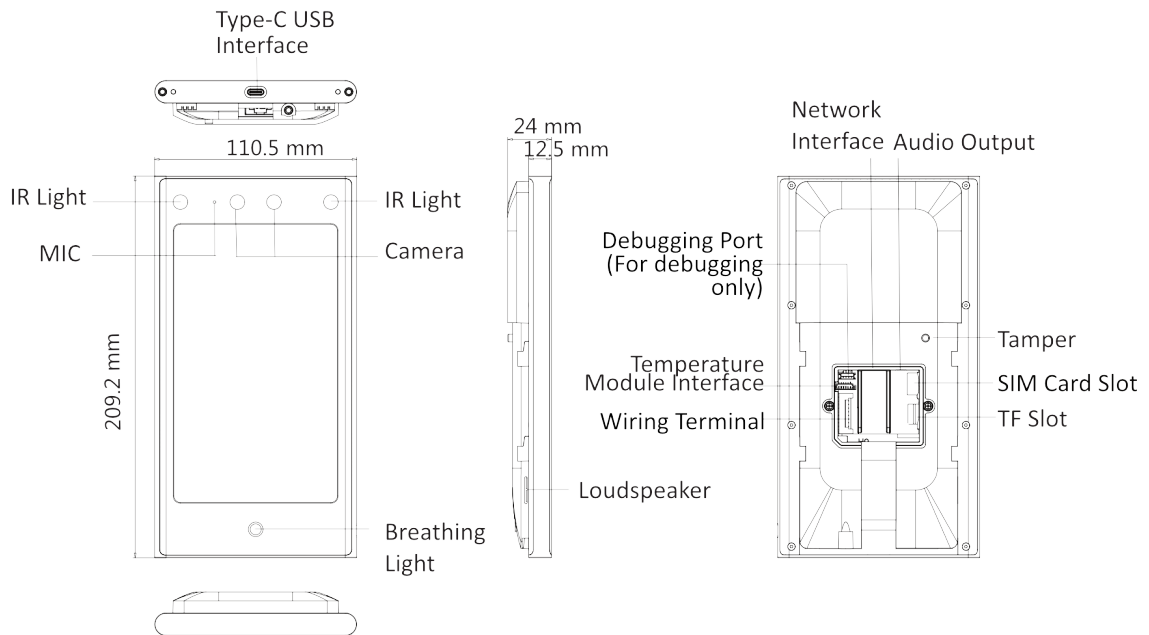

**Figure 1-1 Face Recognition Terminal**

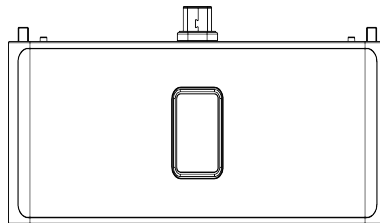

**Figure 1-2 Fingerprint + Bluetooth + QR Code Module**

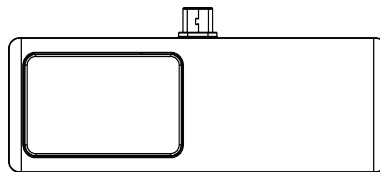

**Figure 1-3 Wireless Module (433/868 Mhz)**

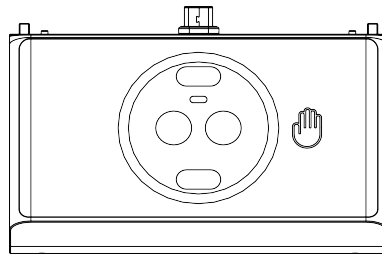

**Figure 1-4 Palm Print and Palm Vein Module**

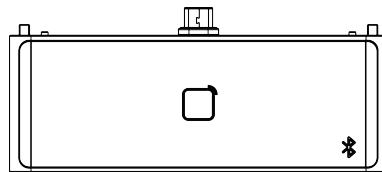

**Figure 1-5 Dual-frequency Card Module (13.56 Mhz and 125 Khz)**

---

 **Note**

- The figures are for reference only.
  - The device supports different modules, which can be accessed according to your actual needs.
  - When the palm print and palm vein module access to the new face recognition terminal, the data of the peripheral module needs to be cleared and re-issued or collected.
  - The surface of the peripheral module should be kept clean to avoid false alarms caused by the sensor.
-

## Chapter 2 Installation

### 2.1 Installation Environment

- Avoid backlight, direct sunlight, and indirect sunlight.
- For better recognition, there should be light source in or near the installation environment.
- If you have to install the device outdoors, you should install a protective shield (optional) for the device.



For details about installation environment, see *Tips for Installation Environment*.

---

### 2.2 Flush Mounting with Gang Box

#### Before You Start

Remove the back sheet of the device.

#### Steps

1. Make sure the gang box is installed on the wall.



Gang box is not supplied.

---

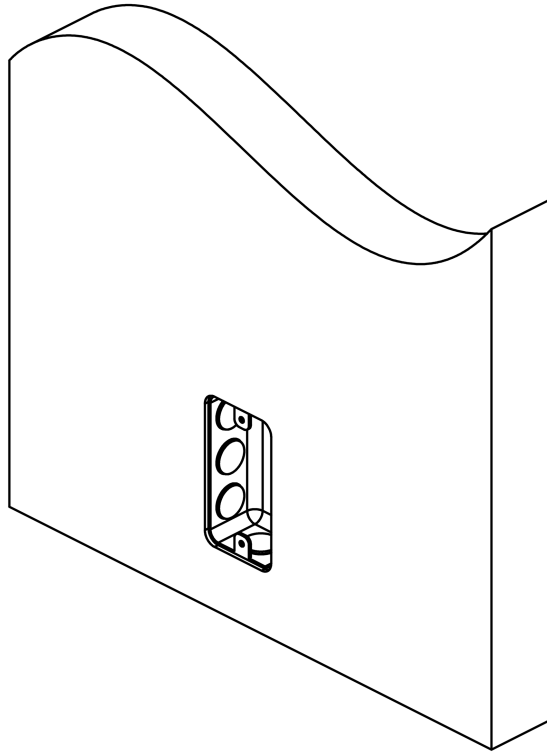

**Figure 2-1 Install Gang Box**

2. Secure the mounting plate on the gang box with 2 supplied screws (SC-K1A4X24\_5).

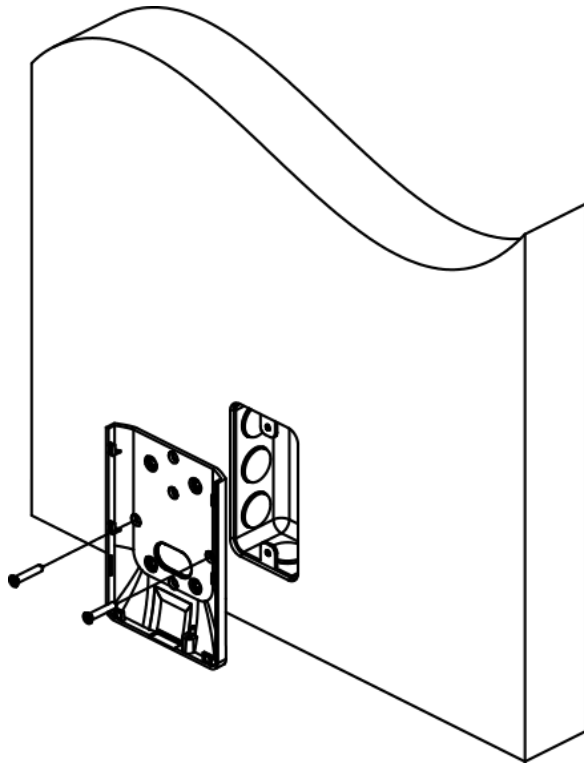

**Figure 2-2 Install Mounting Plate**

- 3.** Route the cable through the cable hole, wire the cables and insert the cables in the gang box.

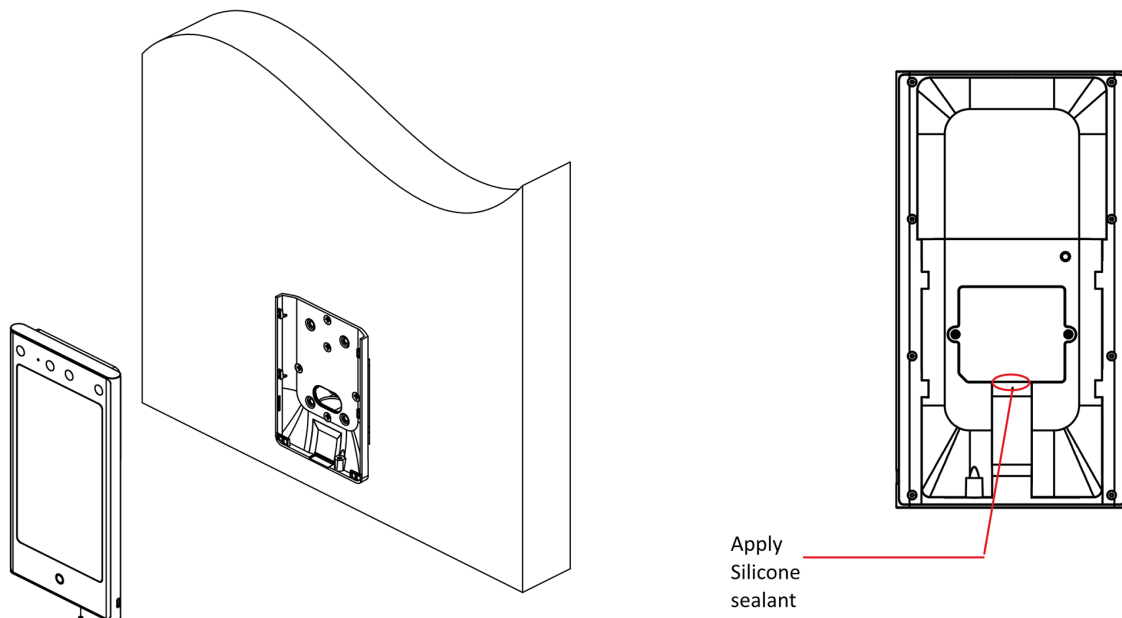

**Figure 2-3 Secure Device**

---

**Note**

Apply Silicone sealant among the cable wiring area to keep the raindrop from entering.

4. Align the device with the mounting plate, and secure the device on the mounting plate with 1 supplied screw (SC-KM3X6-H2-SUS).

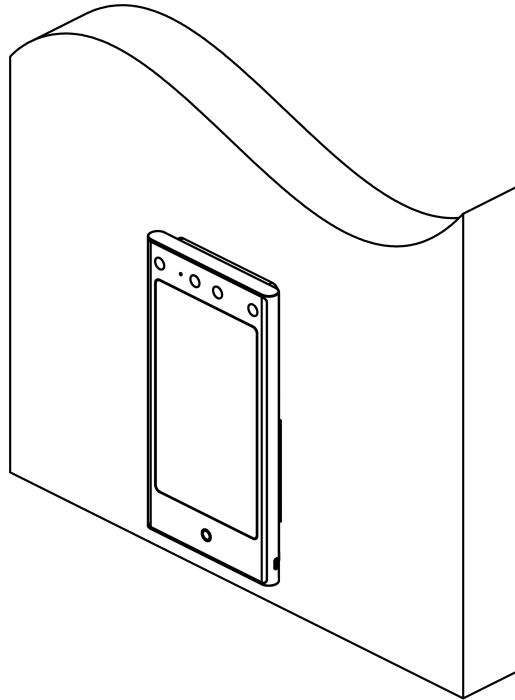

**Figure 2-4 Secure Device**

5. After installation, for the proper use of the device (outdoor use), stick the protection film (parts of models supplied) on the screen.

## 2.3 Surface Mounting

### Steps

---

#### Note

The additional force shall be equal to three times the weight of the equipment. The equipment and its associated mounting means shall remain secure during the installation. After the installation, the equipment, including any associated mounting plate, shall not be damaged.

---

1. According to the datum line on the mounting template, stick the mounting template on the wall or other surfaces, 1.4 meters higher than the ground.

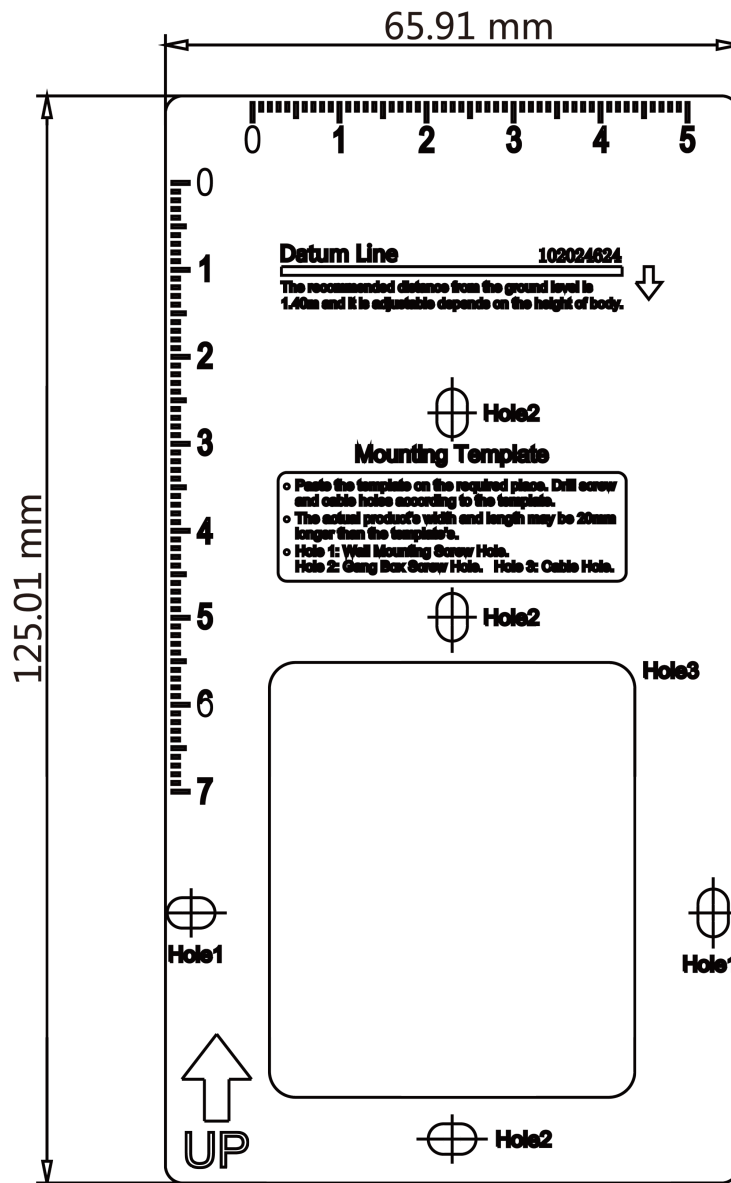
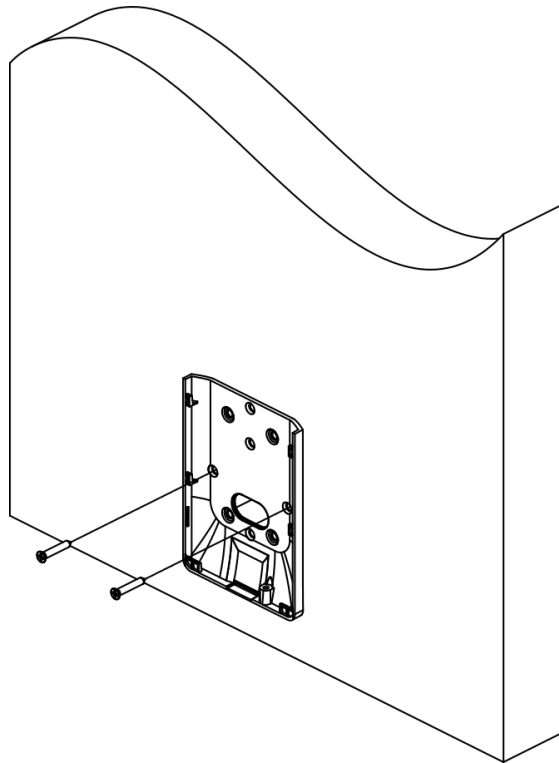

Figure 2-5 Mounting Template

2. Drill holes on the wall or other surface according to the Hole 1 on the mounting template.
3. Remove the cable hole on the mounting plate with tools.
4. Align the holes to the mounting plate and secure the mounting plate on the wall with the 2 supplied screws (K1A×24).





**Figure 2-6 Install Mounting Plate**

5. Route the cable through the cable hole of the mounting plate, and connect to corresponding peripherals cables.

---

 **Note**

If the device is installed outdoor, you should apply silicone sealant to the wiring exit to avoid water from entering.

---

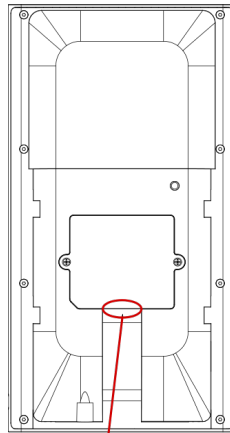

Apply Silicone  
Sealant

**Figure 2-7 Apply Silicone Sealant**

6. Align the device with the mounting plate and hang the device on the mounting plate.

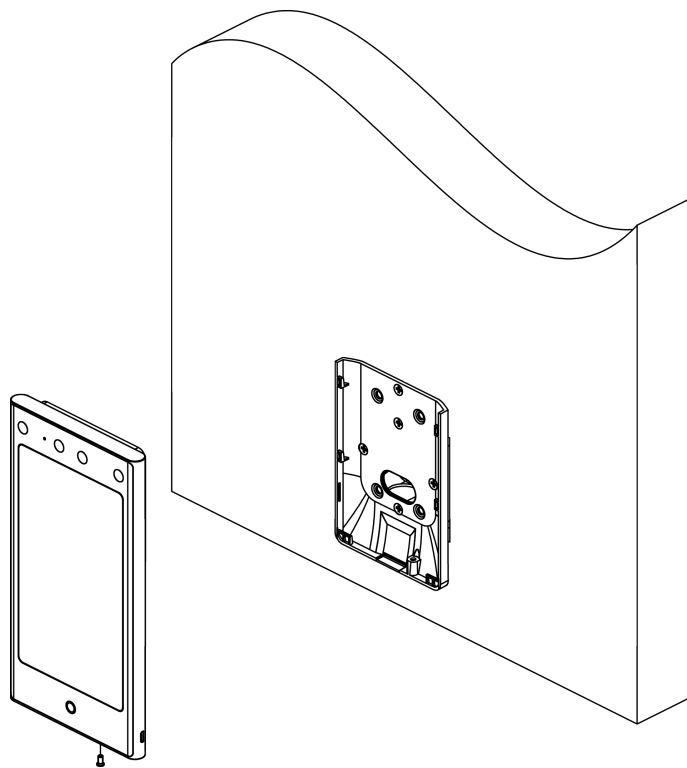

**Figure 2-8 Hang Device**

7. Use 1 supplied screw (KM3×6) to secure the device and the mounting plate.

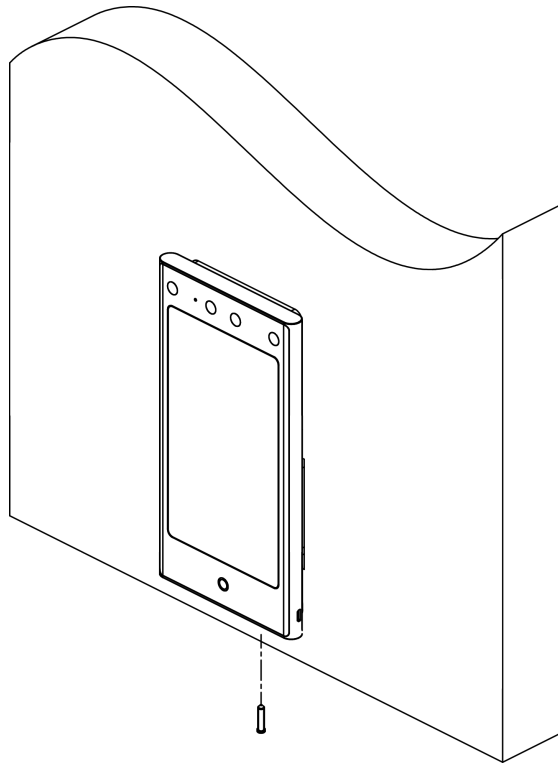

**Figure 2-9 Secure Device**

8. **Optional:** Connect the peripheral module according to your actual needs.
9. After installation, for the proper use of the device (outdoor use), stick the protection film (parts of models supplied) on the screen.

## 2.4 Mount With Bracket

### 2.4.1 Preparation before Mounting with Bracket

#### Steps

1. Drill holes on the turnstile's surface according to the figure displayed below. And install water-proof nut.

---

 **Note**

Solder after pressing rivets to avoid water from entering.

---

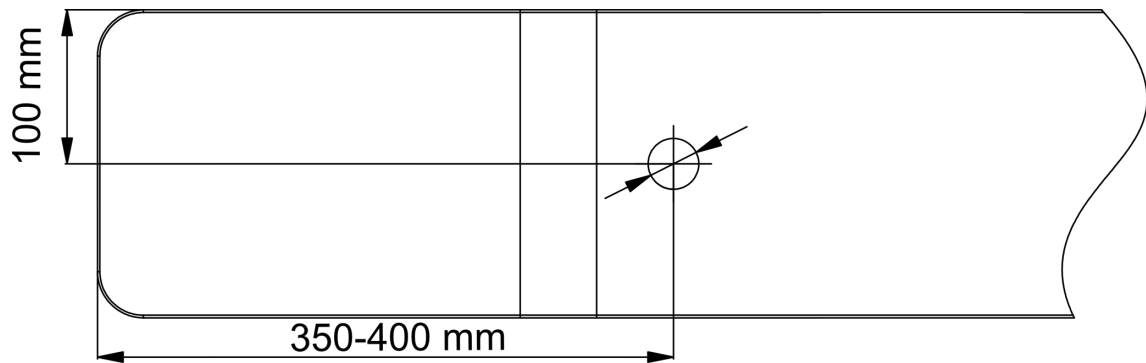

**Figure 2-10 Drill Holes on Turnstile**

2. If the installation angle needs to be 180° perpendicular to the body of the turnstile, the following operations are required.

1) Take off the 3 screws shown in the following figure.

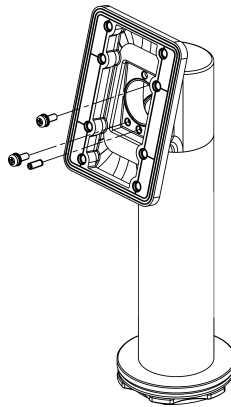

**Figure 2-11 Take off Screws**

2) Rotate the fixed part by 180°, and install the 3 screws back.

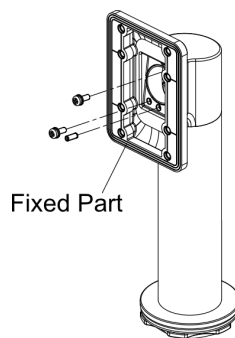

**Figure 2-12 Rotate Fixed Part**

## 2.4.2 Mount Bracket

### Steps

1. Pass the bracket bottom through the turnstile, and fix it into the turnstile with self-contained nut. Adjust the bracket to the suitable angle, and fix the nut tightly by the wrench.

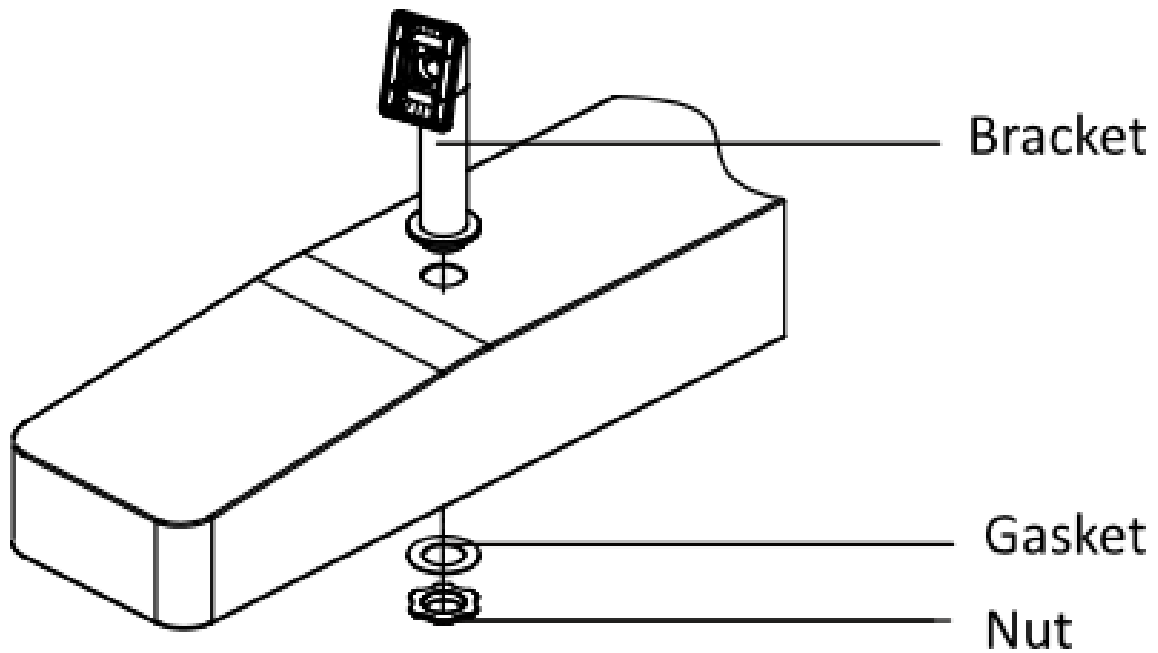
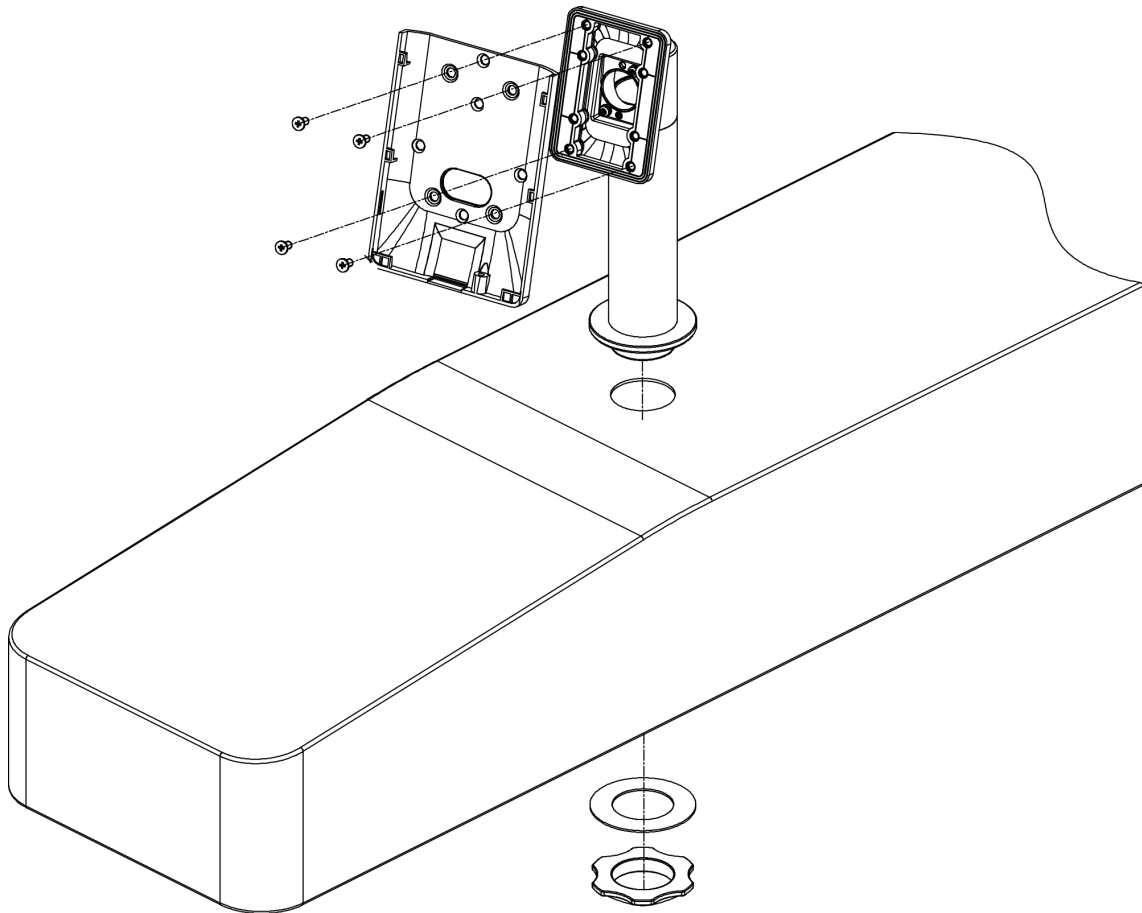

Figure 2-13 Fix Bracket

2. Fix the mounting plate into the bracket by 4 K1M4×8-SUS screws.



**Figure 2-14 Fix Mounting Plate**

3. Pass face recognition terminal cables through the cable hole, and insert them into the inner turnstile. Fix the face recognition terminal into the mounting plate with KM3×6-H2-SUS screws.

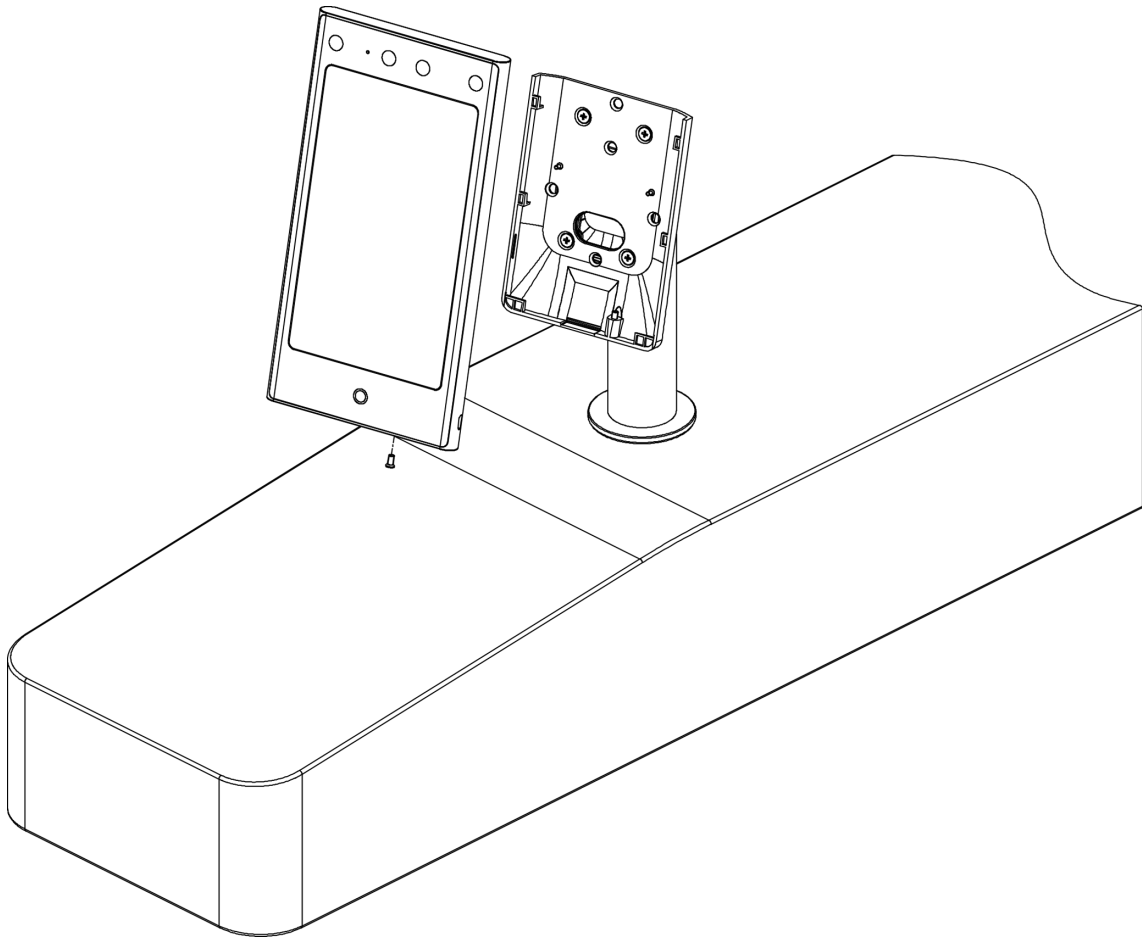

**Figure 2-15 Fix Face Recognition Terminal**

4. After installation, for the proper use of the device (outdoor use), stick the protection film (parts of models supplied) on the screen.

## Chapter 3 Wiring

The device supports connecting to the RS-485 terminal, the door lock, the exit button, the alarm output/input devices, the Wiegand card reader, the access controller, and the power supply. You can wire the peripherals according to the descriptions below.

If connect the Wiegand card reader with the access controller, the face recognition terminal can transmit the authentication information to the access controller and the access controller can judge whether to open the door or not.

---

### Note

- If the cable size is 18 AWG, you should use a 12 V switched-mode power supply. And the distance between the power supply and the device should be no more than 20 m.
  - If the cable size is 15 AWG, you should use a 12 V switched-mode power supply. And the distance between the power supply and the device should be no more than 30 m.
  - If the cable size is 12 AWG, you should use a 12 V switched-mode power supply. And the distance between the power supply and the device should be no more than 40 m.
- 

### 3.1 Terminal Description

The terminals contains power input, alarm input, alarm output, RS-485, Wiegand output, and door lock.

The terminal's diagram is as follows:



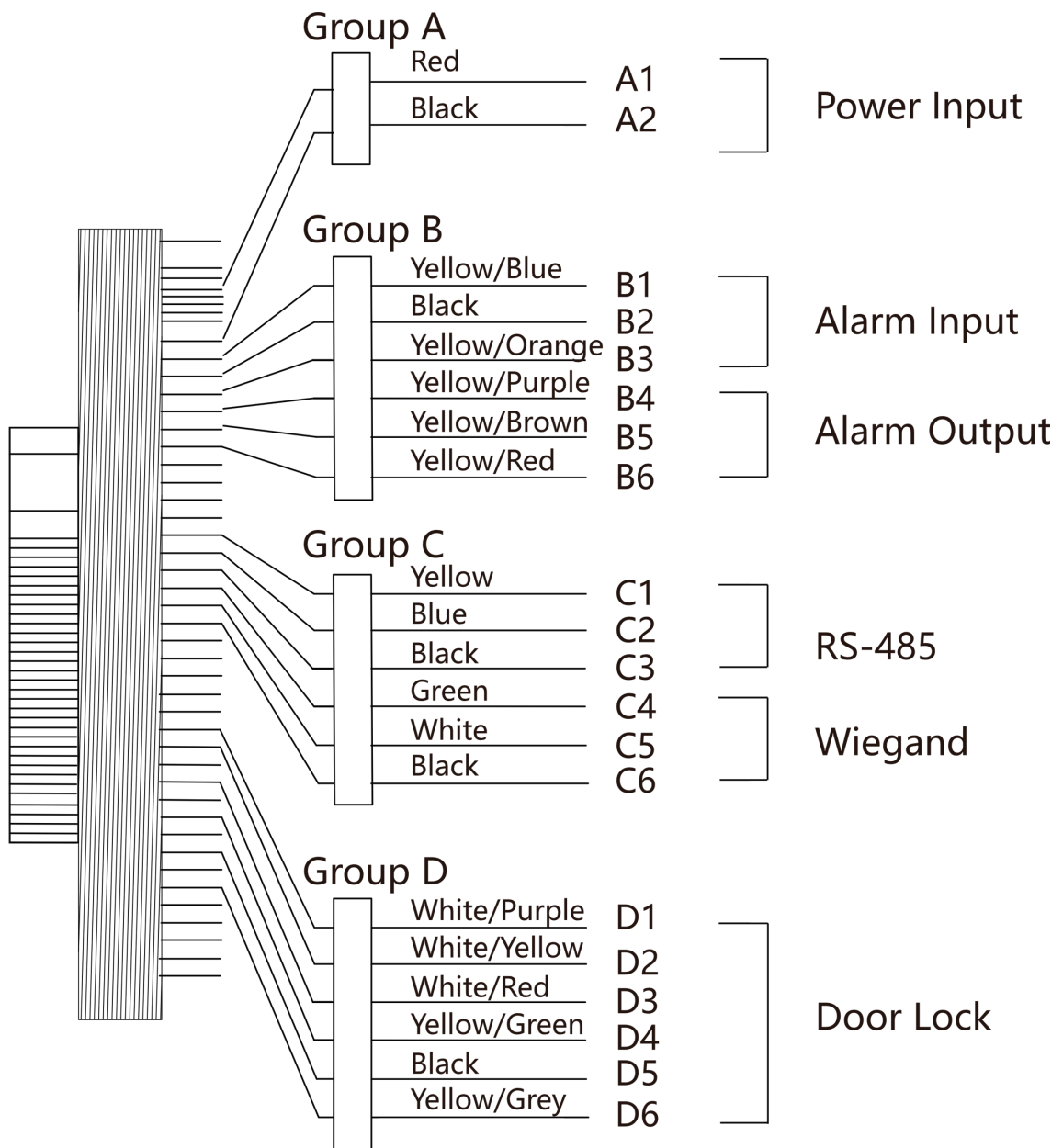

Figure 3-1 Terminal Diagram

The descriptions of the terminals are as follows:

**Table 3-1 Terminal Descriptions**

Group	No.	Function	Color	Name	Description
Group A	A1	Power Input	Red	+12 V	12 VDC Power Supply
	A2		Black	GND	Ground
Group B	B1	Alarm Input	Yellow/Blue	IN1	Alarm Input 1
	B2		Black	GND	Ground
	B3		Yellow/Orange	IN2	Alarm Input 2
	B4	Alarm Output	Yellow/Purple	NC	Alarm Output Wiring
	B5		Yellow/Brown	COM	
	B6		Yellow/Red	NO	
Group C	C1	RS-485	Yellow	485+	RS-485 Wiring
	C2		Blue	485-	
	C3		Black	GND	
	C4	Wiegand	Green	W0	Wiegand Wiring 0
	C5		White	W1	Wiegand Wiring 1
	C6		Black	GND	Ground
Group D	D1	Door Lock	White/Purple	NC	Lock Wiring (NC)
	D2		White/Yellow	COM	Common
	D3		White/Red	NO	Lock Wiring (NO)
	D4		Yellow/Green	SENSOR	Door Contact
	D5		Black	GND	Ground
	D6		Yellow/Grey	BTN	Exit Door Wiring

### 3.2 Wire Normal Device

You can connect the terminal with normal peripherals.

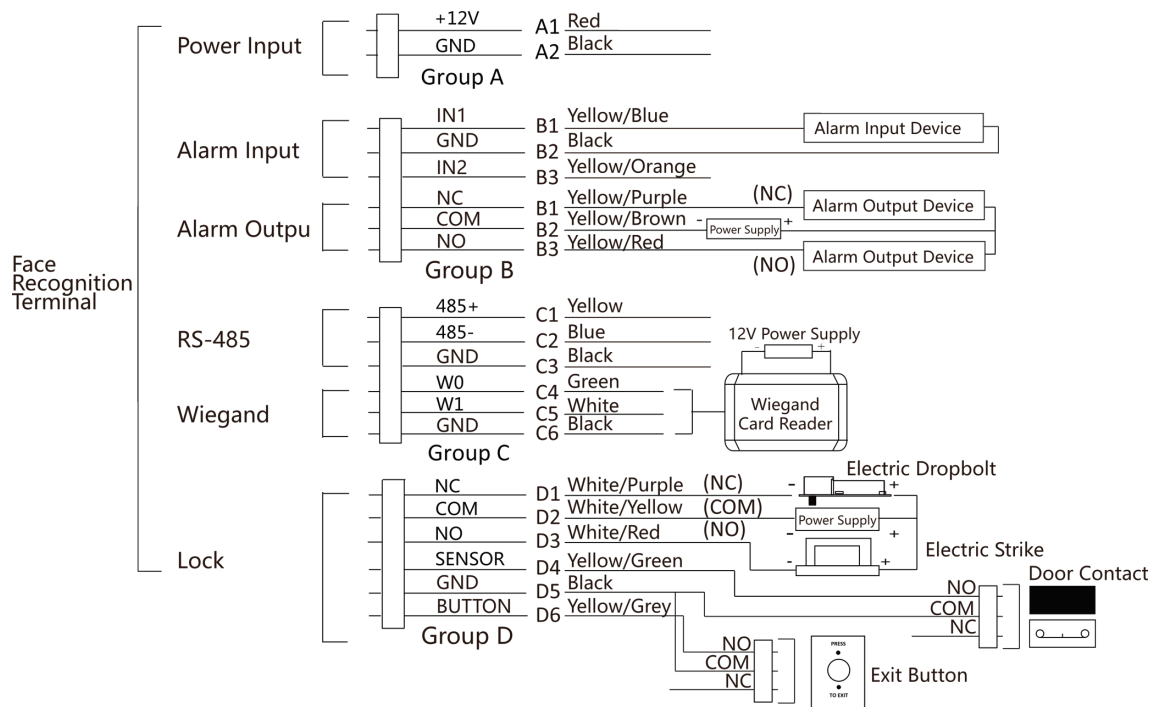

**Figure 3-2 Device Wiring**

**Note**

- You should set the face recognition terminal's Wiegand direction as **Input** to connect to a Wiegand card reader. If connects to an access controller, you should set the Wiegand direction as **Output** to transmit authentication information to the access controller.
- For details about Wiegand direction settings, see [\*\*\*Set Wiegand Parameters\*\*\*](#).
- Do not wire the device to the electric supply directly.

### 3.3 Wire Secure Door Control Unit

You can connect the terminal with the secure door control unit.

The wiring diagram is as follows.

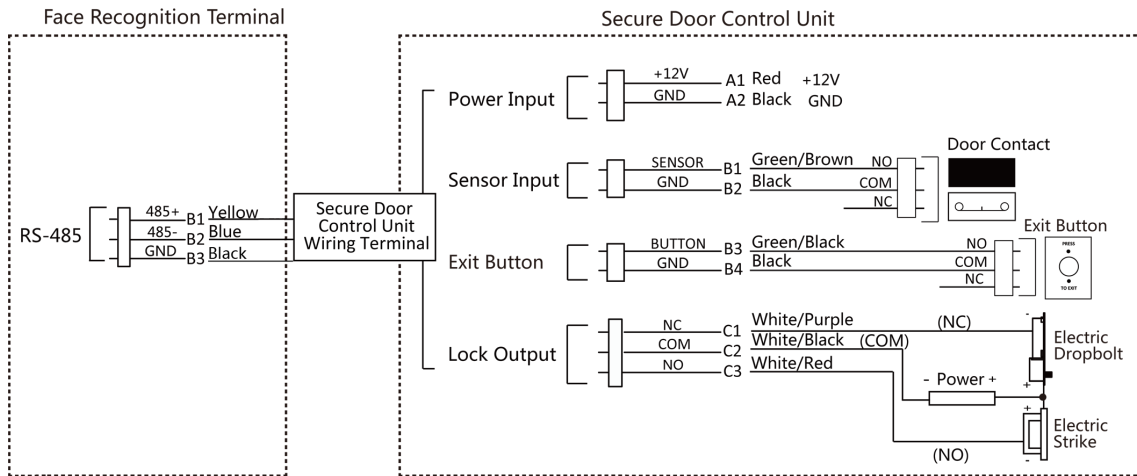

**Figure 3-3 Secure Door Control Unit Wiring**

**Note**

The secure door control unit should connect to an external power supply separately. The suggested external power supply is 12V, 0.5A.

## 3.4 Wire Fire Module

### 3.4.1 Wiring Diagram of Door Open When Powering Off

Lock Type: Anode Lock, Magnetic Lock, and Electric Bolt (NO)

Security Type: Door Open When Powering Off

Scenario: Installed in Fire Engine Access

#### Type 1

**Note**

The fire system controls the power supply of the access control system.

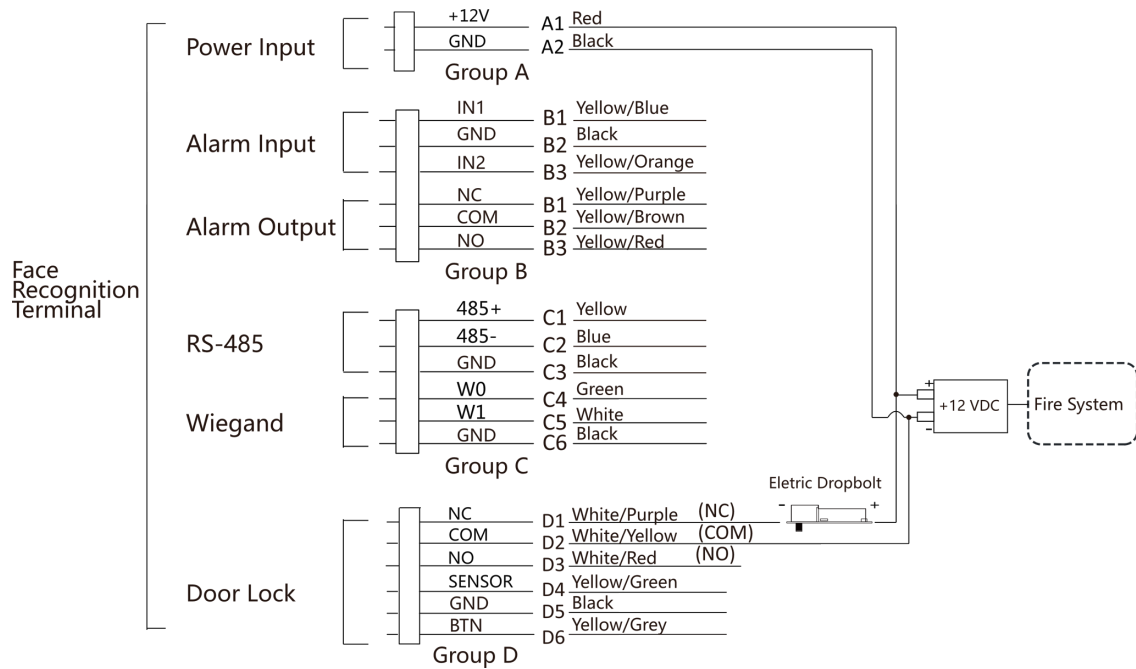

**Figure 3-4 Wire Device**

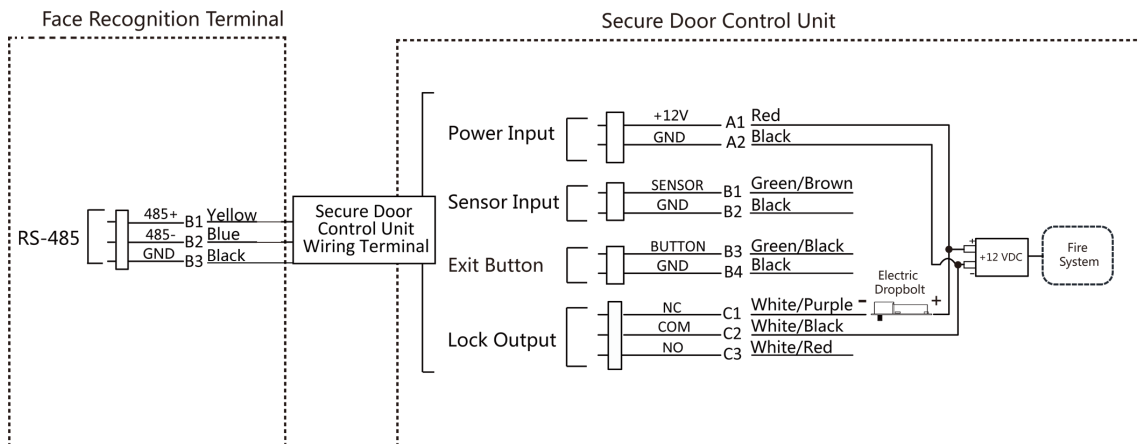

**Figure 3-5 Wire Secure Door Control Unit**

## Type 2

### Note

The fire system (NO and COM, normally open when powering off) is connected with the lock and the power supply in series. When an fire alarm is triggered, the door remains open. In normal times, NO and COM are closed.

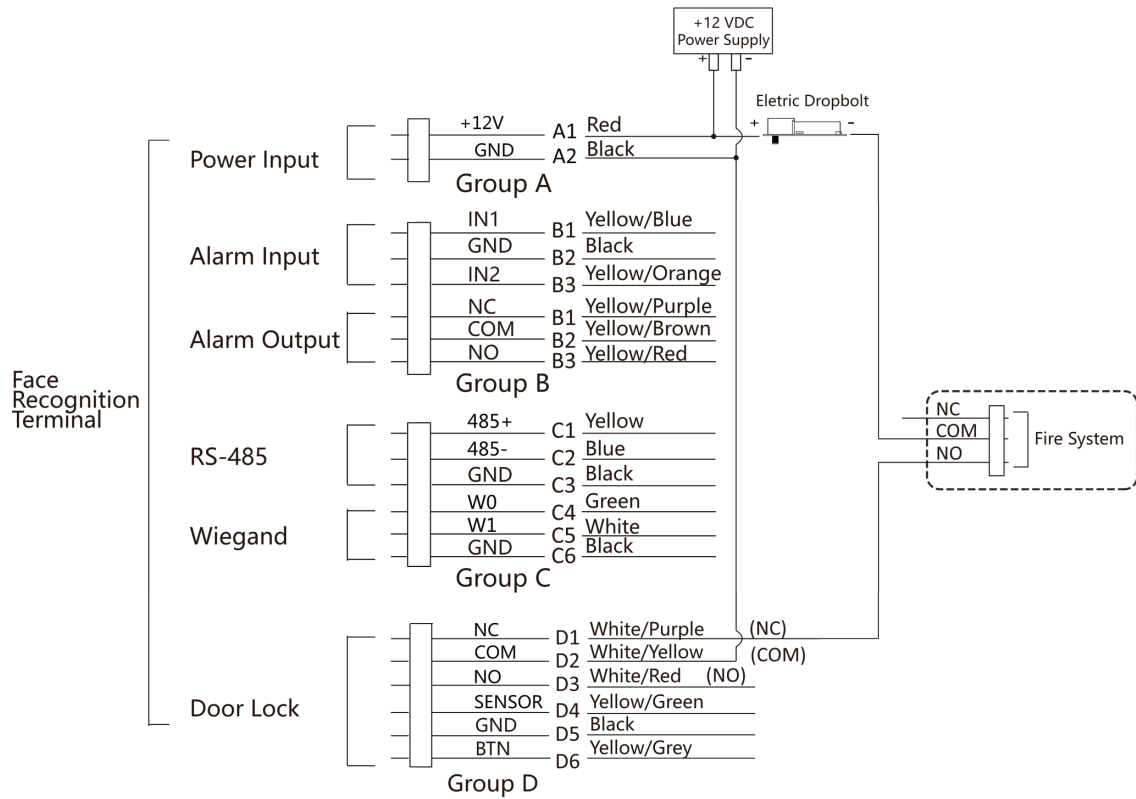

Figure 3-6 Wiring Device

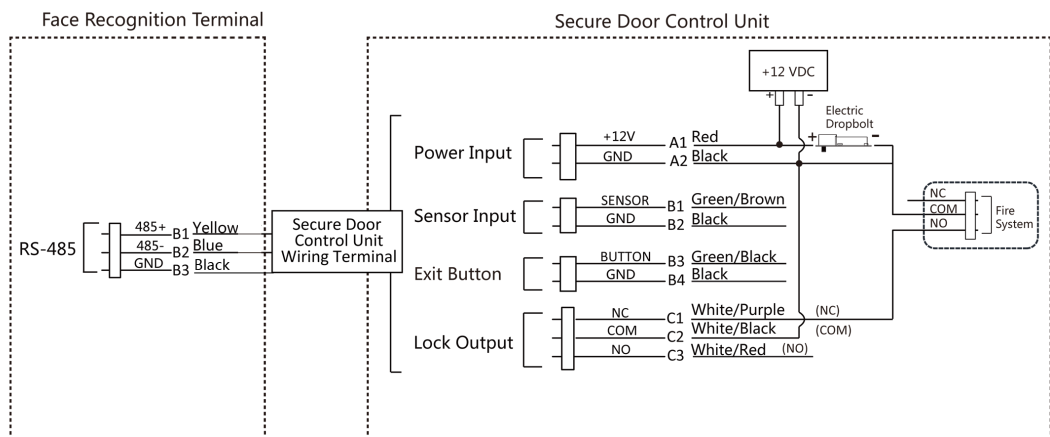

Figure 3-7 Wiring Secure Door Control Unit

### 3.4.2 Wiring Diagram of Door Locked When Powering Off

Lock Type: Cathode Lock, Electric Lock, and Electric Bolt (NC)

Security Type: Door Locked When Powering Off

Scenario: Installed in Entrance/Exit with Fire Linkage

**Note**

- The Uninterruptible Power Supply (UPS) is required.
- The fire system (NC and COM, normally closed when powering off) is connected with the lock and the power supply in series. When an fire alarm is triggered, the door remains open. In normal times, NC and COM are open.

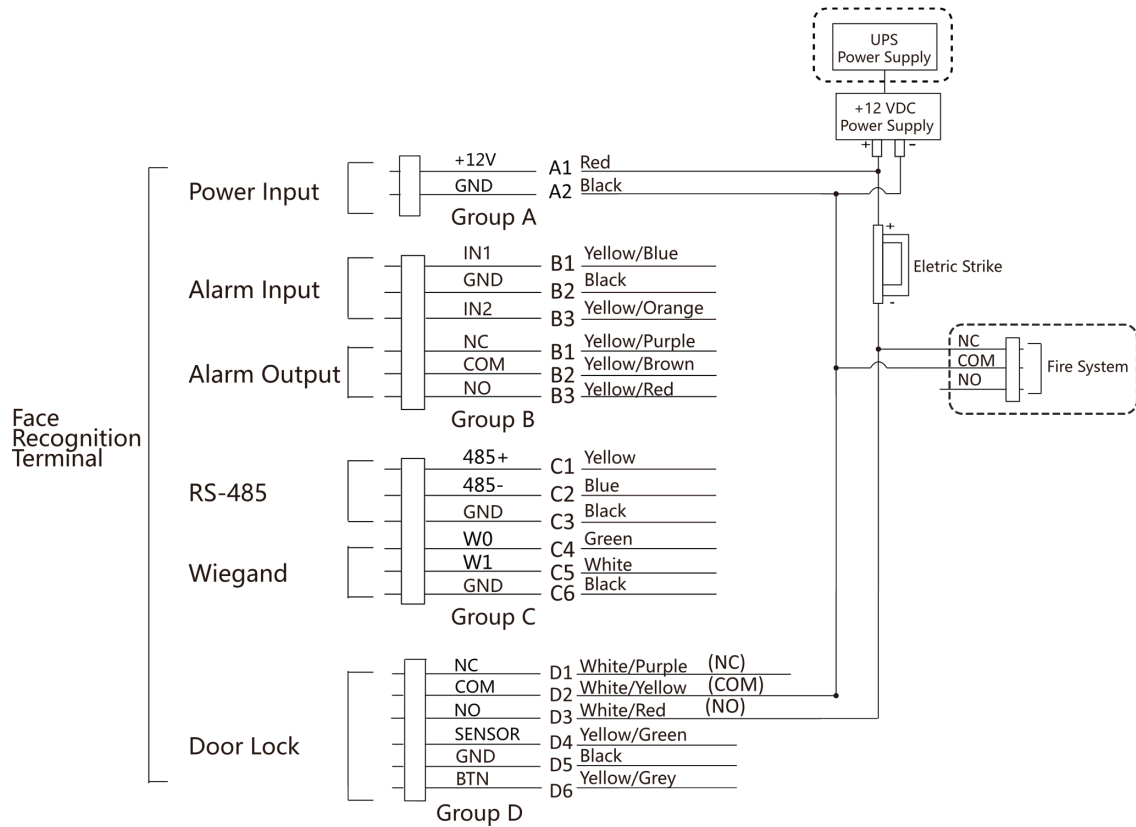

**Figure 3-8 Device Wiring**

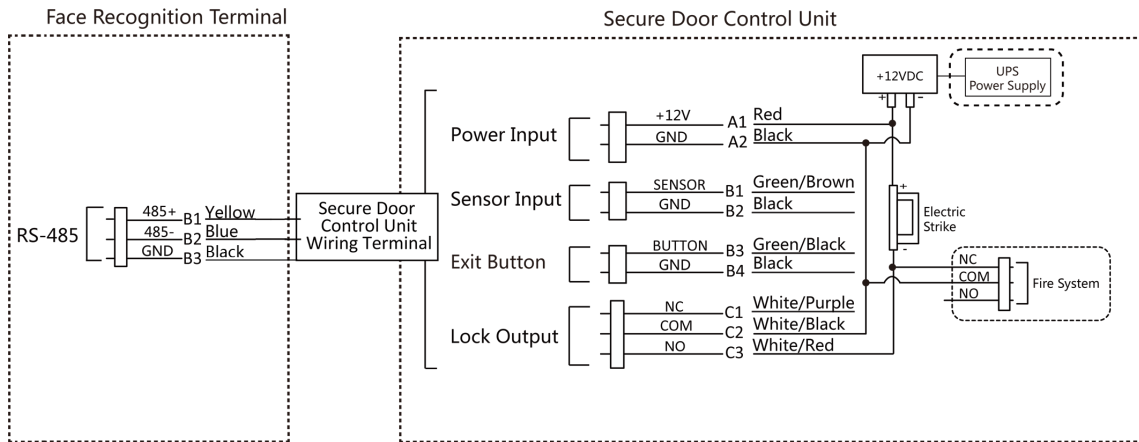

**Figure 3-9 Wiring Diagram**



## Chapter 4 Palm Print and Palm Vein Indicator Description

Indicator	Description
Solid Red	The device is offline.
Fast-flashing Red	The palms are too close.
Slow-flashing Red	Authenticating failed.
The green light is on for 3 s	Authenticating succeed.

## Chapter 5 Activation

You should activate the device before the first login. After powering on the device, the system will switch to Device Activation page.

Activation via the device, SADP tool and the client software are supported.

The default values of the device are as follows:

- The default IP address: 192.0.0.64
- The default port No.: 8000
- The default user name: admin

### 5.1 Activate via Device

If the device is not activated, you can activate the device after it is powered on.

On the Activate Device page, create a password and confirm the password. Tap **Activate** and the device will be activated.

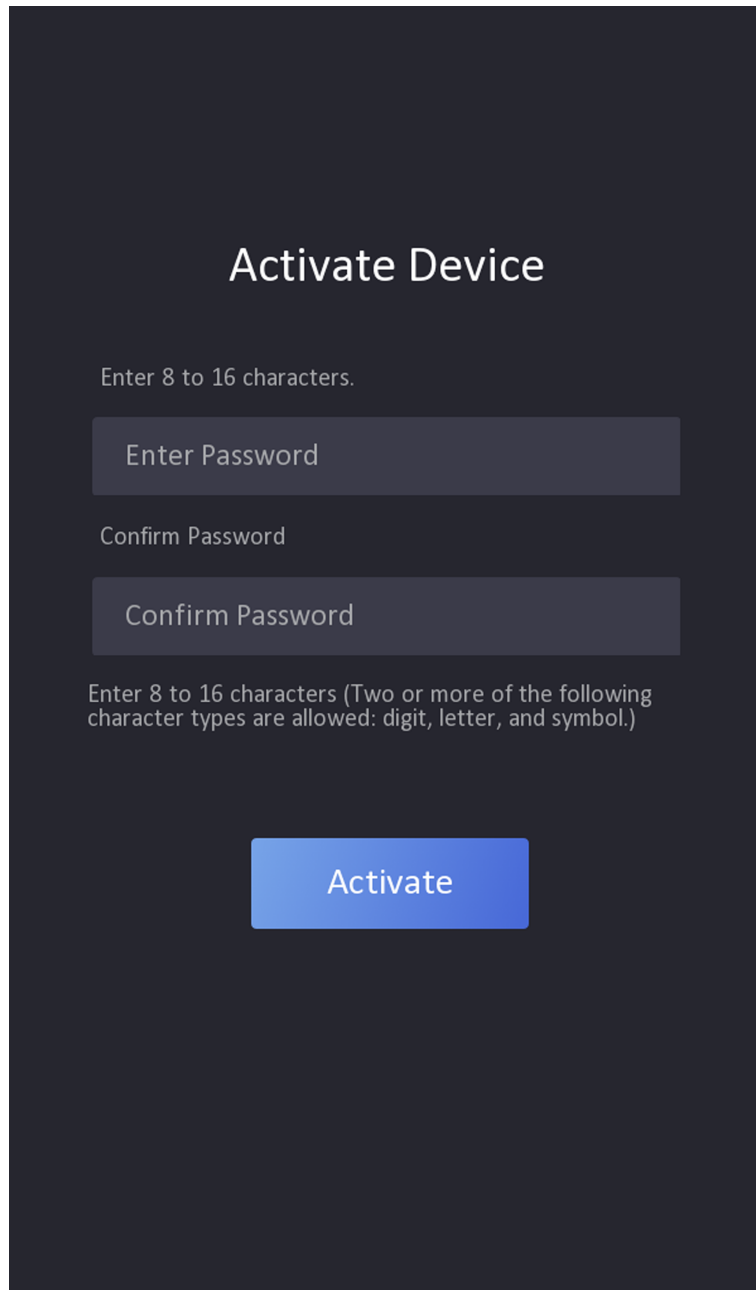

Figure 5-1 Activation Page

---

 **Caution**

- The password strength of the device can be automatically checked. We highly recommend you change the password of your own choosing (using a minimum of 8 characters, including at least three kinds of following categories: upper case letters, lower case letters, numbers, and special

characters) in order to increase the security of your product. And we recommend you change your password regularly, especially in the high security system, changing the password monthly or weekly can better protect your product.

- Proper configuration of all passwords and other security settings is the responsibility of the service provider and/or end-user.
  - Do not contain following characters in the password: the user name, 123, admin (case-insensitive), 4 or more continuously increasing or decreasing digits, or 4 or more consecutively repeated characters.
  - Password cannot contain words such as hik, hkws, and hikvision (case insensitive).
- 

## 5.2 Activate via Web Browser

You can activate the device via the web browser.

### Steps

1. Enter the device default IP address (192.0.0.64) in the address bar of the web browser, and press **Enter**.



Make sure the device IP address and the computer's should be in the same IP segment.

2. Create a new password (admin password) and confirm the password.



- The password strength of the device can be automatically checked. We highly recommend you change the password of your own choosing (using a minimum of 8 characters, including at least three kinds of following categories: upper case letters, lower case letters, numbers, and special characters) in order to increase the security of your product. And we recommend you change your password regularly, especially in the high security system, changing the password monthly or weekly can better protect your product.
- Proper configuration of all passwords and other security settings is the responsibility of the service provider and/or end-user.
- Do not contain following characters in the password: the user name, 123, admin (case-insensitive), 4 or more continuously increasing or decreasing digits, or 4 or more consecutively repeated characters.
- Password cannot contain words such as hik, hkws, and hikvision (case insensitive).

3. Click **Activate**.

4. Edit the device IP address. You can edit the IP address via the SADP tool, the device, and the client software.

## 5.3 Activate via SADP

SADP is a tool to detect, activate and modify the IP address of the device over the LAN.

### Before You Start

- Get the SADP software from the supplied disk or the official website <http://www.hikvision.com/en/>, and install the SADP according to the prompts.
- The device and the PC that runs the SADP tool should be within the same subnet.

The following steps show how to activate a device and modify its IP address. For batch activation and IP addresses modification, refer to *User Manual of SADP* for details.

### Steps

1. Run the SADP software and search the online devices.
2. Find and select your device in online device list.
3. Input new password (admin password) and confirm the password.



### Caution

**STRONG PASSWORD RECOMMENDED**-We highly recommend you create a strong password of your own choosing (using a minimum of 8 characters, including upper case letters, lower case letters, numbers, and special characters) in order to increase the security of your product. And we recommend you reset your password regularly, especially in the high security system, resetting the password monthly or weekly can better protect your product.

---



### Note

Characters containing admin and nimda are not supported to be set as activation password.

---

4. Click **Activate** to start activation.

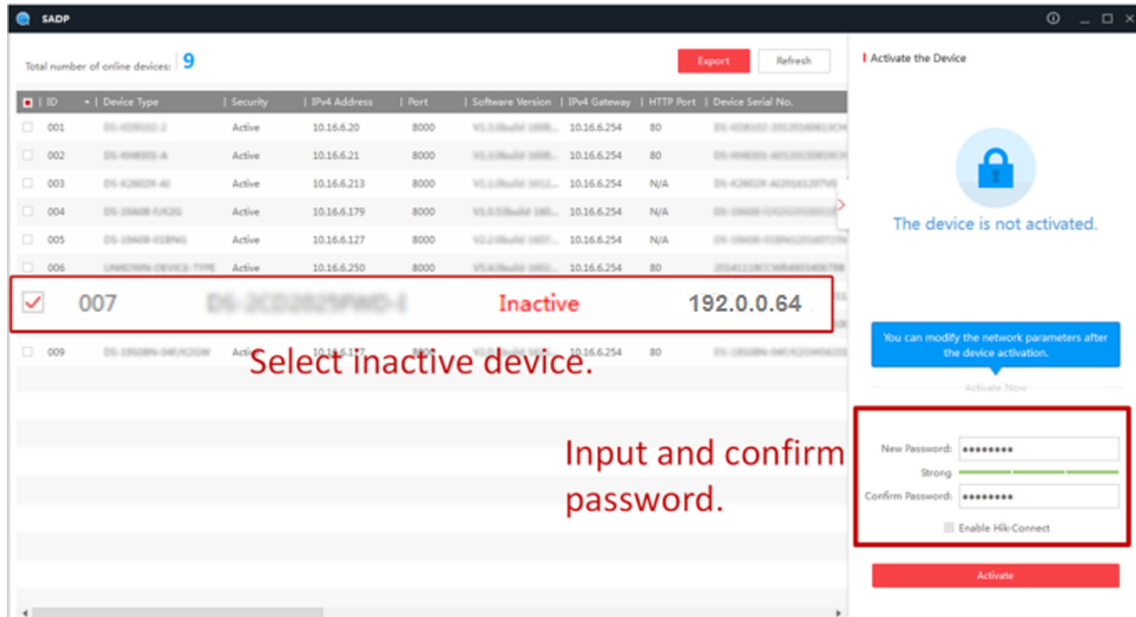

Status of the device becomes **Active** after successful activation.

## 5. Modify IP address of the device.

- 1) Select the device.
- 2) Change the device IP address to the same subnet as your computer by either modifying the IP address manually or checking **Enable DHCP**.
- 3) Input the admin password and click **Modify** to activate your IP address modification.

## 5.4 Activate Device via iVMS-4200 Client Software

For some devices, you are required to create the password to activate them before they can be added to the iVMS-4200 software and work properly.

### Steps



#### Note

This function should be supported by the device.

1. Enter the Device Management page.
2. Click  on the right of **Device Management** and select **Device**.
3. Click **Online Device** to show the online device area.  
The searched online devices are displayed in the list.
4. Check the device status (shown on **Security Level** column) and select an inactive device.
5. Click **Activate** to open the Activation dialog.
6. Create a password in the password field, and confirm the password.



### Caution

The password strength of the device can be automatically checked. We highly recommend you change the password of your own choosing (using a minimum of 8 characters, including at least three kinds of following categories: upper case letters, lower case letters, numbers, and special characters) in order to increase the security of your product. And we recommend you change your password regularly, especially in the high security system, changing the password monthly or weekly can better protect your product.

Proper configuration of all passwords and other security settings is the responsibility of the installer and/or end-user.

---



### Note

Characters containing admin and nimda are not supported to be set as activation password.

---

7. Click **OK** to activate the device.

## Chapter 6 Quick Operation

### 6.1 Select Language

You can select a language for the device system.

After the device activation, you can select a language for the device system.



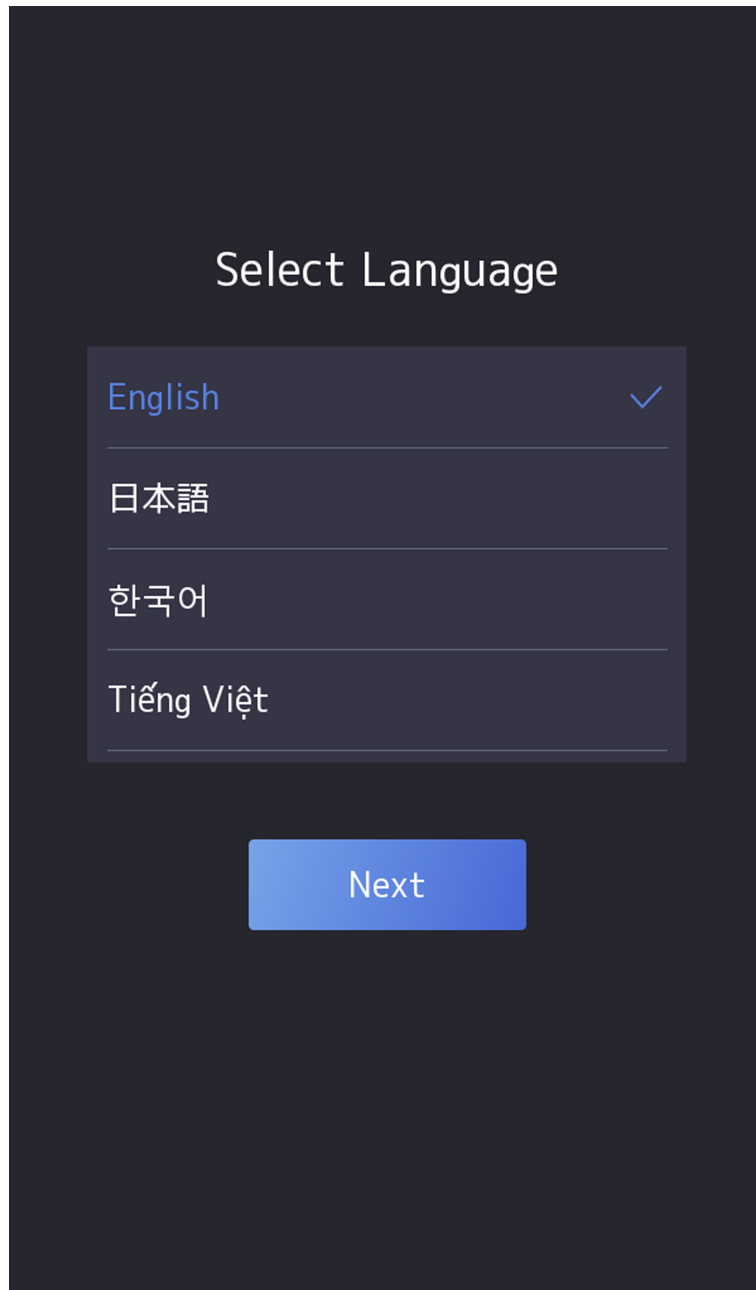

**Figure 6-1 Select System Language**

By default, the system language is English.

---

 **Note**

After you change the system language, the device will reboot automatically.

---

## 6.2 Set Password Change Type

You can set the password change type as reserved email address or security questions. Once you forgot the device password, you can change the password via the selected change type.

### Change Password via Email Address

If you need to change password via reserved email, you can enter an email address, and tap **Next**.

### Change via Security Questions

If you need to change password via security questions, you can tap **Change to Security Questions** on the right corner. Select the security questions and enter the answers. Tap **Next**.



You can only select one type to change password. If you need, you can enter the web page to set both of the changing types.

---

## 6.3 Set Network Parameters

You can set the network for the device.

### Steps



Parts of the device models supports wi-fi function. Refers to the actual device for details.

---

1. When you enter the Select Network page, tap **Wired Network** or **Wi-Fi** for your actual needs.

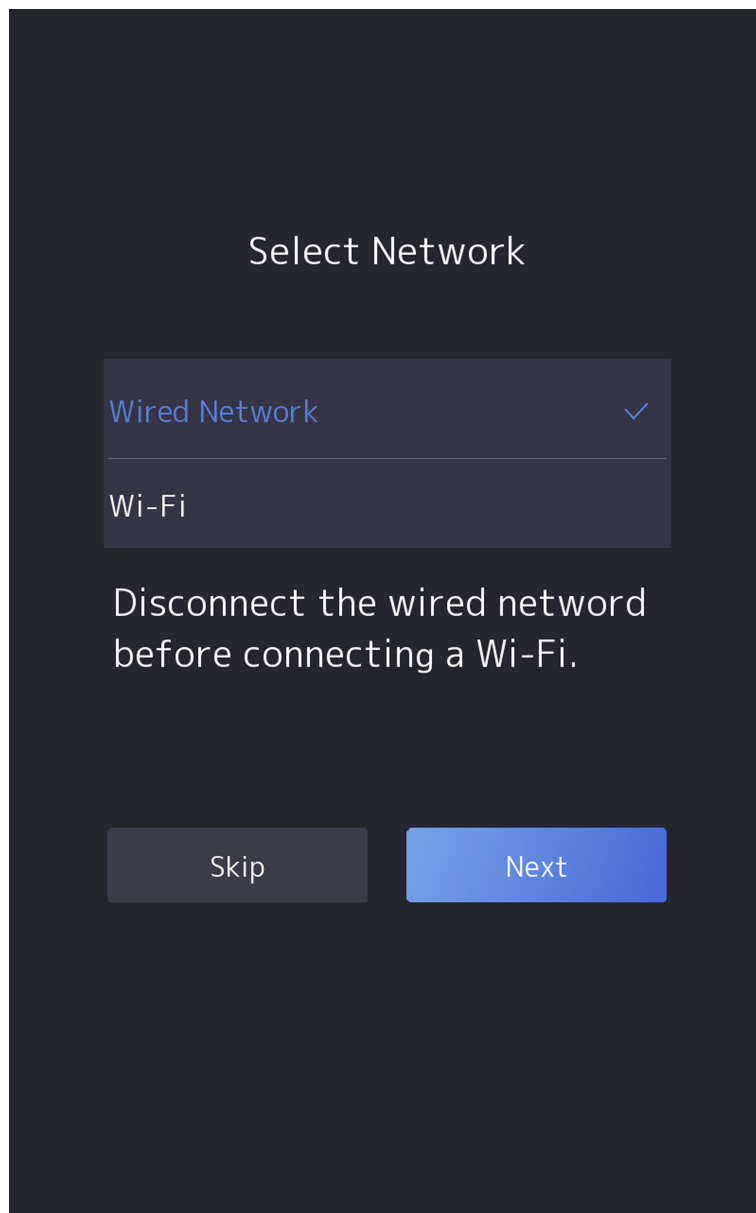

**Figure 6-2 Select Network**

---

 **Note**

Disconnect the wired network before connecting a Wi-Fi.

---

**2. Tap Next.**

**Wired Network**

---

 **Note**

Make sure the device has connected to a network.

---

If enable **DHCP**, the system will assign the IP address and other parameters automatically.

If disable **DHCP**, you should set the IP address, the subnet mask, and the gateway.

### **Wi-Fi**

Select a Wi-Fi and enter the Wi-Fi's password to get connected.

Or tap **Add Wi-Fi** and enter the Wi-Fi's name and the password to get connected.

**3. Optional:** Tap **Skip** to skip network settings.

## **6.4 Access to Platform**

Enable the function and the device can communicate via Hik-Connect. You can add the device to Hik-Connect mobile client and so on.

### **Steps**

**1.** Enable **Access to Hik-Connect**, and set the server IP and verification code.

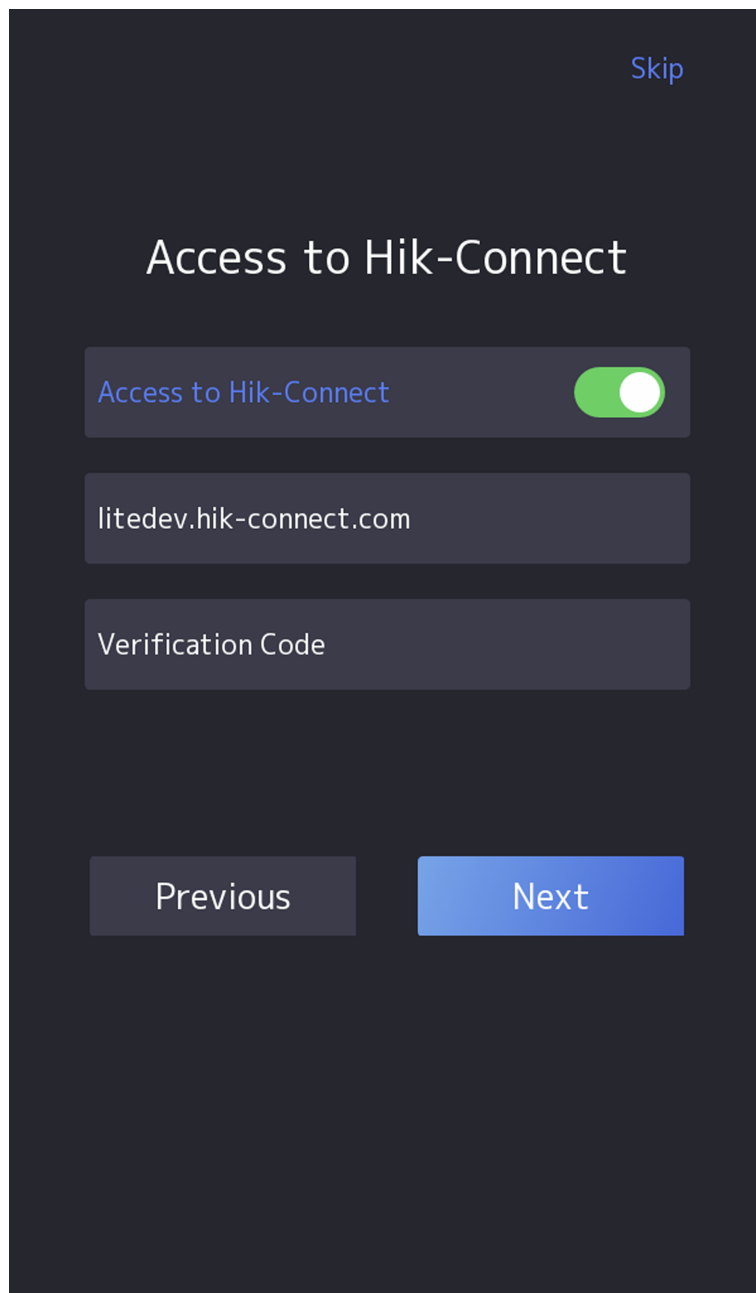

**Figure 6-3 Access to Hik-Connect**

2. Tap **Next**.
3. **Optional:** Tap **Skip** to skip the step.
4. **Optional:** Tap **Previous** to go to the previous page.



If you tap **Previous** to return to the Wi-Fi configuration page, you need to tap the connected Wi-Fi or connect another Wi-Fi to enter the platform page again.

---

### 6.5 Privacy Settings

After activation, selecting application mode, and selecting network, you should set the privacy parameters, including the picture uploading and storage.

Select parameters according to your actual needs.

#### **Upload Captured Pic. When Auth. (Upload Captured Picture When Authenticating)**

Upload the pictures captured when authenticating to the platform automatically.

#### **Save Captured Pic. When Auth. (Save Captured Picture When Authenticating)**

If you enable this function, you can save the picture when Authenticating to the device.

#### **Save Registered Pic. (Save Registered Picture)**

The registered face picture will be saved to the system if you enable the function.

#### **Upload Pic. After Linked Capture (Upload Picture After Linked Capture)**

Upload the pictures captured by linked camera to the platform automatically.

#### **Save Pic. After Linked Capture (Save Pictures After Linked Capture)**

If you enable this function, you can save the picture captured by linked camera to the device.

Tap **Next** to complete the settings.

### 6.6 Set Administrator

After device activation, you can add an administrator to manage the device parameters.

#### **Before You Start**

Activate the device and select an application mode.

#### **Steps**

- 1. Optional:** Tap **Skip** to skip adding administrator if required.
- 2.** Enter the administrator's name (optional) and tap **Next**.

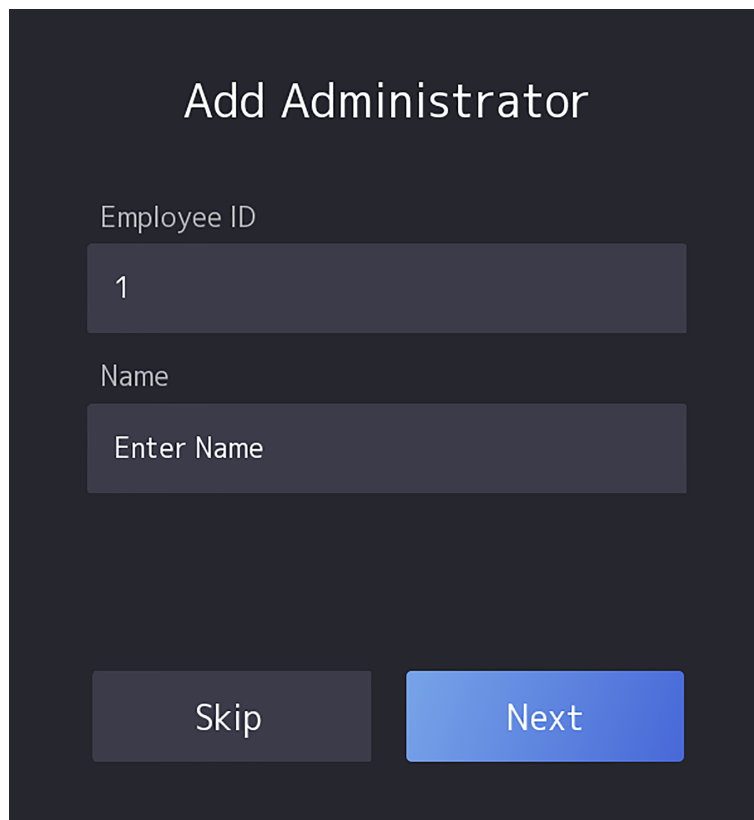

**Figure 6-4 Add Administrator Page**







3. Select a credential to add.

---

 **Note**

Up to one credential should be added.

---

-  : Face forward at the camera. Make sure the face is in the face recognition area. Click  to capture and click  to confirm.
  -  : Press your finger according to the instructions on the device screen. Click  to confirm.
  -  : Enter the card No. or present card on the card presenting area. Click **OK**.
- 

 **Note**

Only devices connected to the external fingerprint module support fingerprint function.

---

4. Click **OK**.

You will enter the authentication page.

## 6.7 Authentication Page Instructions

Introduce the authentication page.

## Status Bar Instructions



Device is armed/not armed.



The device' Wi-Fi is enabled and signal is strong/Wi-Fi is enabled but not connected/Wi-Fi's IP address is conflict.



The device wired network is connected/not connected/connecting failed.



The device's mobile network has no signal/2G strong signal/3G strong signal/4G strong signal/5G strong signal.



The device is added to VoIP/not added to VoIP.



The device's SIP server is registered/registering failed/registered on door station but not on main station.



The palm print and palm vein module is online or offline.



The dual-frequency card module is online.

## Authentication Page Icon

---



### Note

The displayed icon on the authentication page can be controlled. For details, see shortcut key settings in ***Set Shortcut Key via Device*** .

---



Show QR code to the camera and you can authenticate via the QR code.



- Enter the room No., and tap **OK** to call.
- Tap  to call the center.



### Note

The device should be added to the center, or the calling operation will be failed.

---



Enter PIN to authenticate.



## Chapter 7 Basic Operation

### 7.1 Login

Login the device to set the device basic parameters.

#### 7.1.1 Login by Administrator

If you have added an administrator for the device, only the administrator can login the device for device operation.

##### Steps

1. Long tap on the initial page for 3 s and slide to the left/right by following the gesture to enter the admin login page.

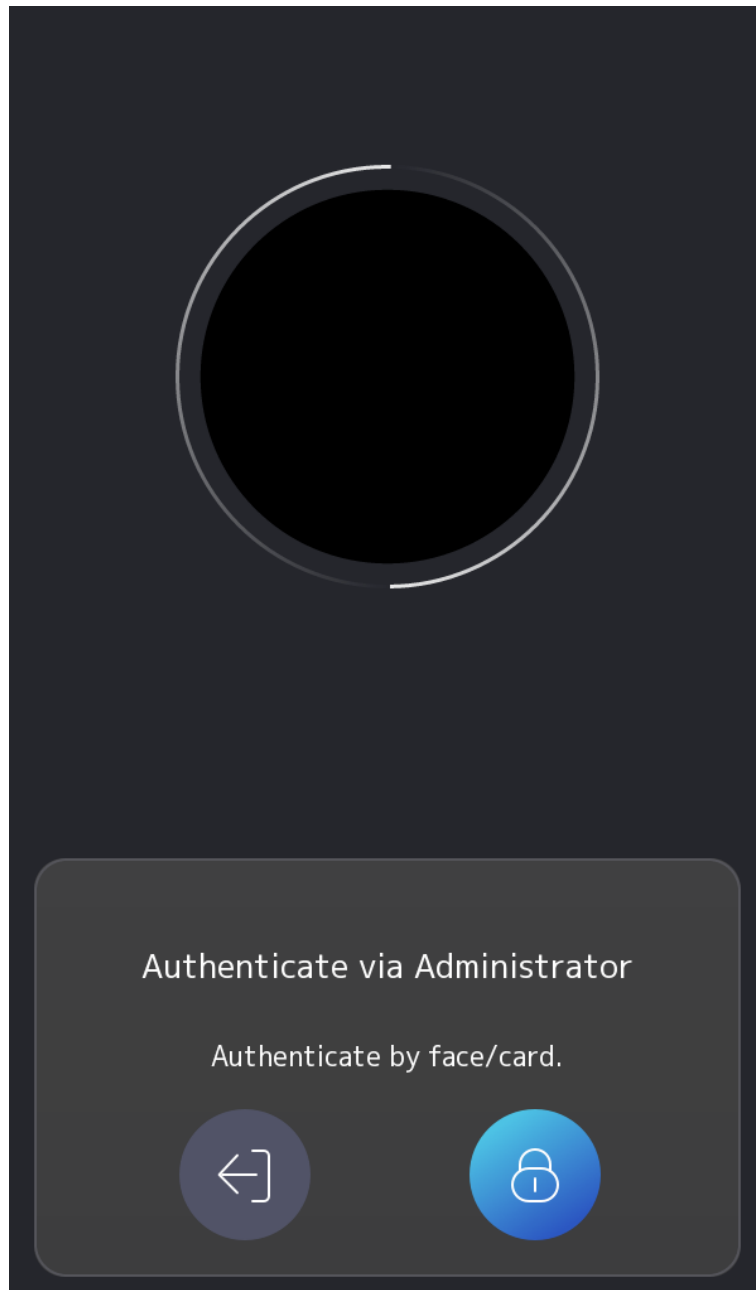

**Figure 7-1 Admin Login**

2. Authenticate the administrator's face, fingerprint, or card to enter the home page.

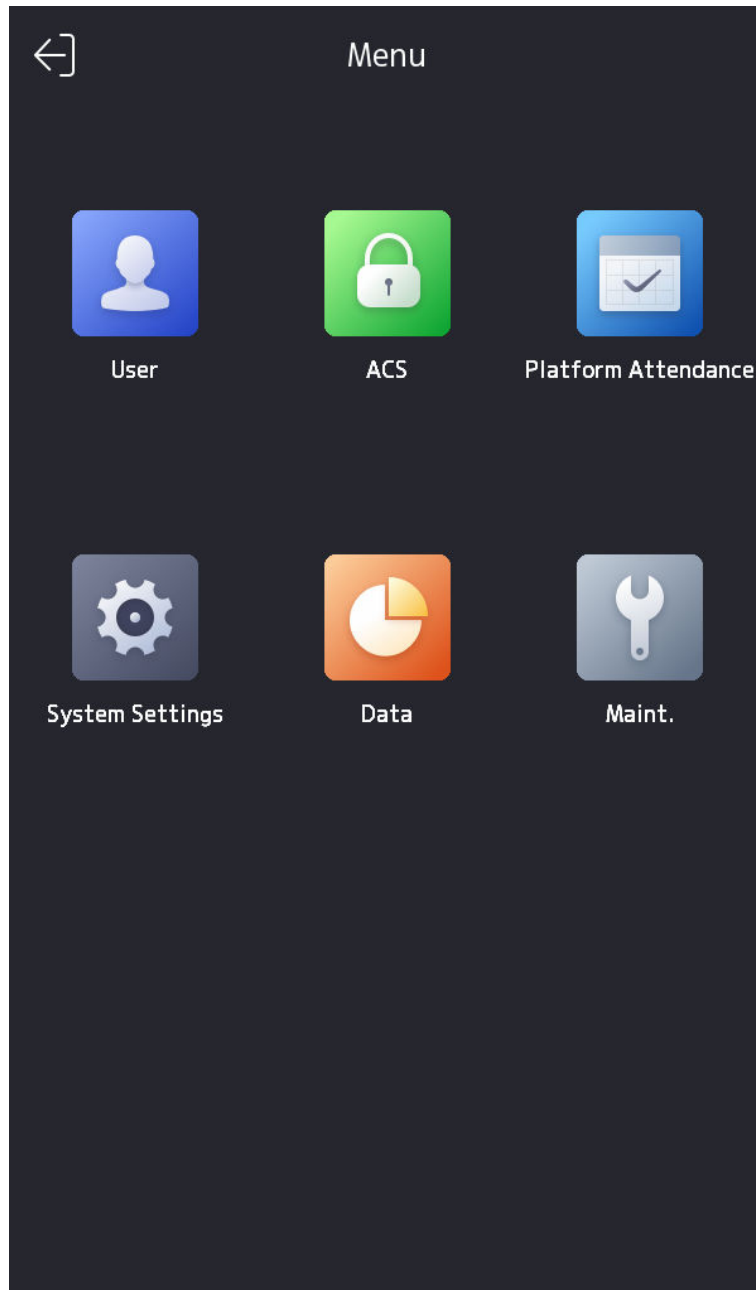



**Figure 7-2 Home Page**

---

 **Note**

The device will be locked for 30 minutes after 5 failed fingerprint or card attempts.

- 
3. **Optional:** Tap  and you can enter the device activation password for login.
  4. **Optional:** Tap  and you can exit the admin login page.

### 7.1.2 Login by Activation Password

You should login the system before other device operations. If you do not configure an administrator, you should follow the instructions below to login.

#### Steps

1. Long tap on the initial page for 3 s and slide to the left/right by following the gesture to enter password entering page.
2. Enter the password.
  - If you have added an administrator for the device, tap  and enter the password.
  - If you haven't added an administrator for the device, enter the password.
3. Tap **OK** to enter the home page.

---

#### **Note**

The device will be locked for 30 minutes after 5 failed password attempts.

---

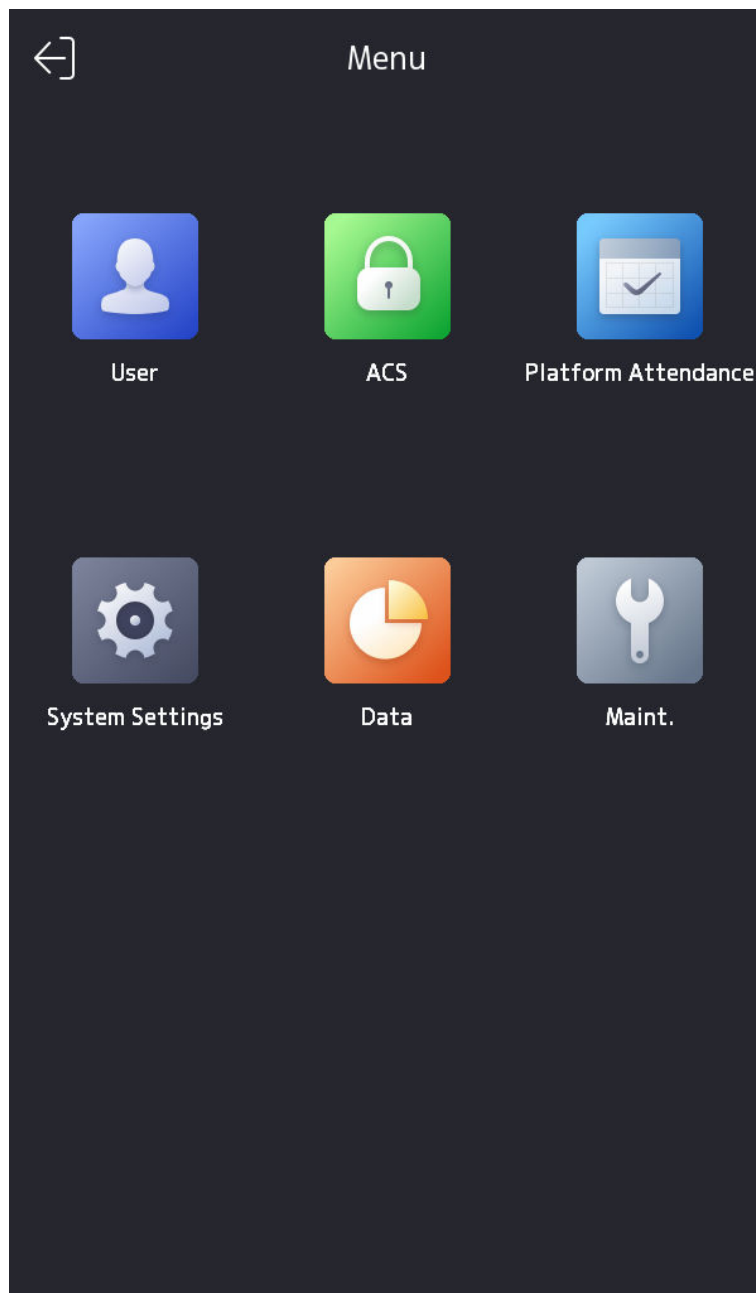

**Figure 7-3 Home Page**

### **7.1.3 Forgot Password**

If you forget the password during authentication, you can change the password.

## Steps

1. Hold the initial page for 3 s and slide to the left/right by following the gesture and log in the page.
  2. **Optional:** If you have set an administrator, tap  in the pop-up admin authentication page.
  3. Tap **Forgot Password**.
  4. Select a password change type from the list.
- 



If you have only set 1 password change type, you will go to the corresponded password change page for further settings.

---

5. Answer the security questions or change the password according to email address.
    - Security Questions: Answer the security questions that configured when activation.
    - Email Address
- 



Make sure the device has added to the Hik-Connect account.

---

- a. Download Hik-Connect app.
  - b. Go to **More** → **Reset Device Password** .
  - c. Scan the QR code on the device and a verification code will be popped up.
- 



Tap the QR code to get a larger picture.

---

- d. Enter the verification code on the device page.
6. Create a new password and confirm it.
  7. Tap **OK**.

## 7.1.4 Change Device Password

You can change the device password by entering the old password.

### Steps

1. Long tap on the initial page for 3 s and login the home page. Tap **System** → **Password** .
  2. Tap **Change Device Password**.
  3. Enter the device old password.
- 



If you forget your password, you can tap **Forgot Password** and change the password. For details, see ***Forgot Password*** .

---

4. Enter new password and confirm the password.



## Caution

The password strength of the device can be automatically checked. We highly recommend you change the password of your own choosing (using a minimum of 8 characters, including at least three kinds of following categories: upper case letters, lower case letters, numbers, and special characters) in order to increase the security of your product. And we recommend you change your password regularly, especially in the high security system, changing the password monthly or weekly can better protect your product.

Proper configuration of all passwords and other security settings is the responsibility of the installer and/or end-user.

---

5. Tap **OK**.

## 7.2 Communication Settings

You can set the wired network, the Wi-Fi parameter, the RS-485 parameters, the Wiegand parameters, ISUP and access to Hik-Connect on the communication settings page.

### 7.2.1 Set Wired Network Parameters

You can set the device wired network parameters, including the IPv4/IPv6 IP address, the subnet mask, the gateway, and DNS parameters.

#### Steps

1. Tap **System** → **Comm.** (Communication Settings) on the Home page to enter the Communication Settings page.
2. On the Communication Settings page, tap **Wired Network**.

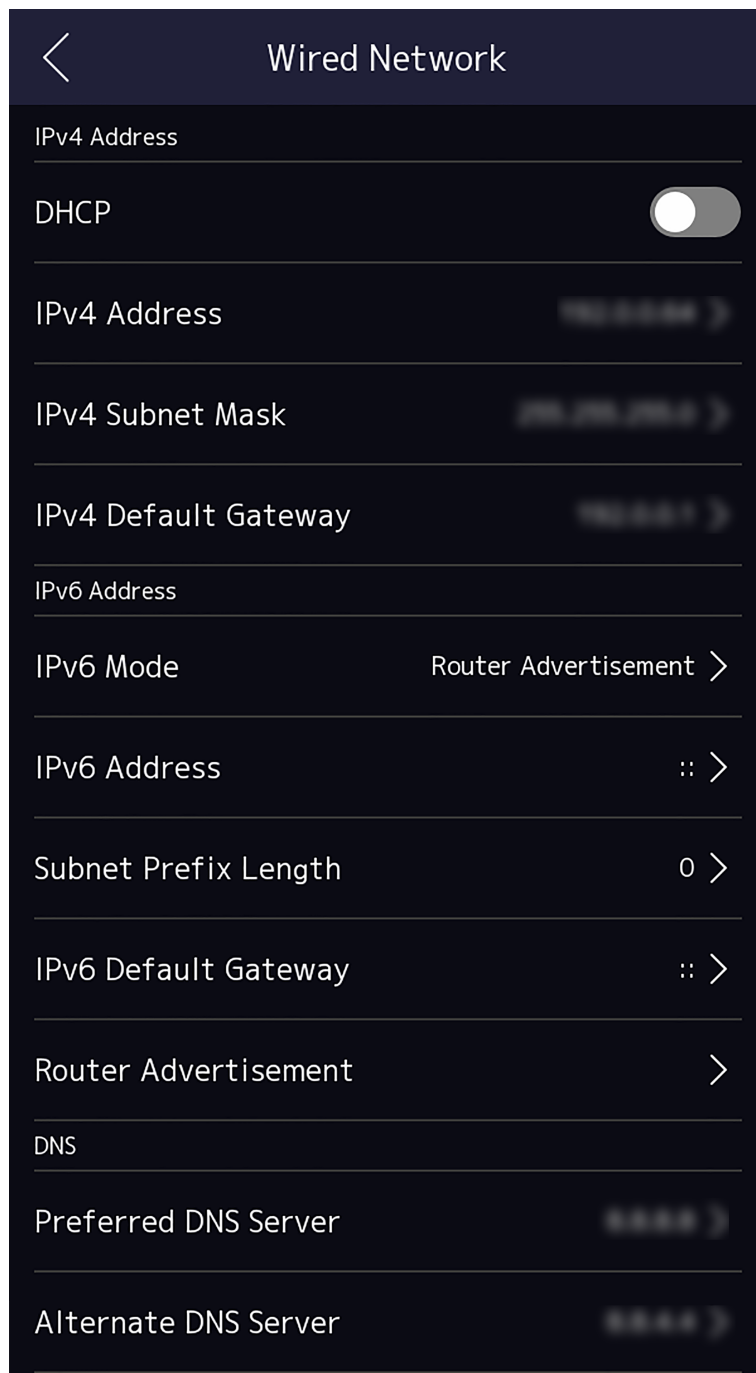

**Figure 7-4 Wired Network Settings**

3. Set IPv4/IPv6 IP Address, Subnet Mask, and Gateway.
- Enable **DHCP**, and the system will assign IP address, subnet mask, and gateway automatically.
  - Disable **DHCP**, and you should set the IP address, subnet mask, and gateway manually.



---

## Note

The device's IP address and the computer IP address should be in the same IP segment.

4. Set the DNS parameters. You can enable **Auto Obtain DNS**, set the preferred DNS server and the alternate DNS server.

## 7.2.2 Set Wi-Fi Parameters

You can enable the Wi-Fi function and set the Wi-Fi related parameters.

### Steps

---

## Note

The function should be supported by the device.

1. Tap **System** → **Comm.** (Communication Settings) on the Home page to enter the Communication Settings page.
2. On the Communication Settings page, tap.

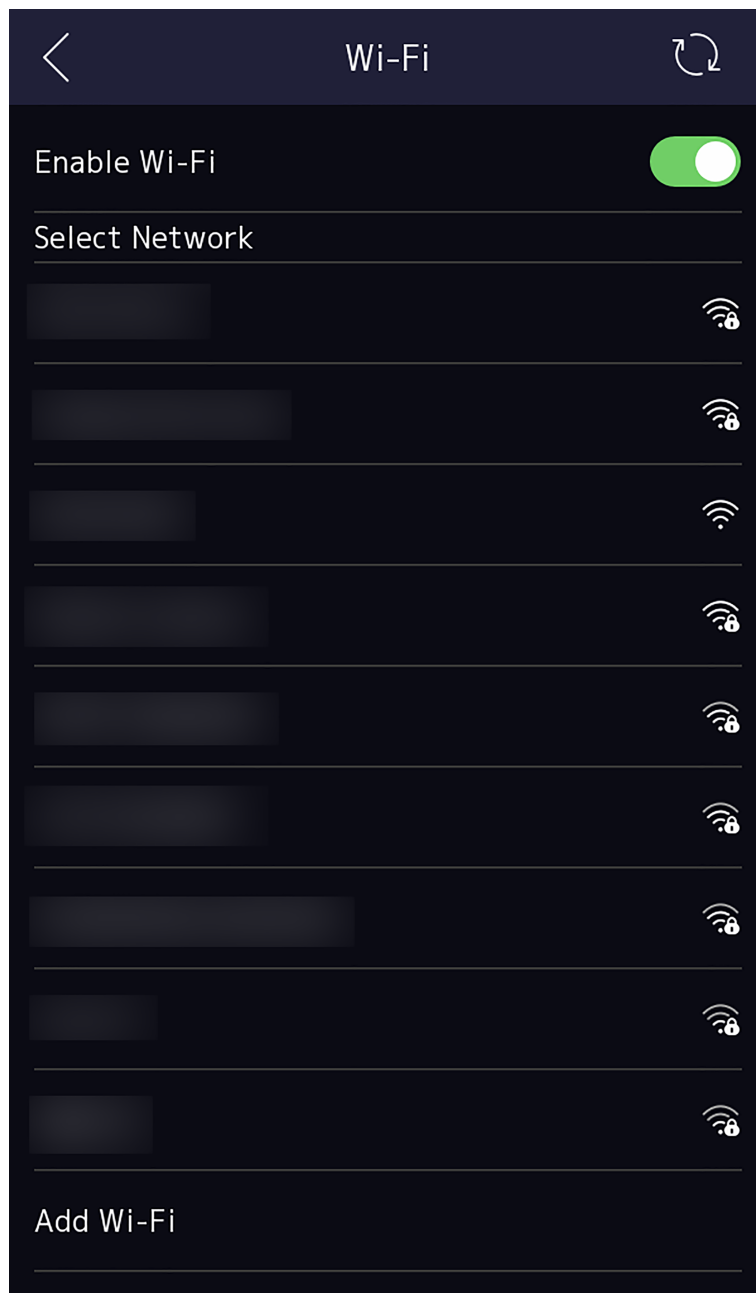

Figure 7-5 Wi-Fi Settings

3. Enable the Wi-Fi function.
4. Configure the Wi-Fi parameters.
  - Select a Wi-Fi from the list, and enter the Wi-Fi's password. Tap **OK**.
  - If the target Wi-Fi is not in the list, tap **Add Wi-Fi**. Enter the Wi-Fi's name and password. And tap **OK**.

---

## Note

Only digits, letters, and special characters are allowed in the password.

---

5. Set the Wi-Fi's parameters.
  - By default, DHCP is enable. The system will allocate the IP address, the subnet mask, and the gateway automatically.
  - If disable DHCP, you should enter the IP address, the subnet mask, and the gateway manually.
6. Tap **OK** to save the settings and go back to the Wi-Fi tab.
7. Tap  to save the network parameters.

## 7.2.3 Set RS-485 Parameters

The face recognition terminal can connect external access controller, secure door control unit, card reader, or QR code scanner via the RS-485 terminal.

### Steps

1. Tap **System** → **Comm.** (Communication Settings) on the Home page to enter the Communication Settings page.
2. On the Communication Settings page, tap **RS-485** to enter the RS-485 tab.

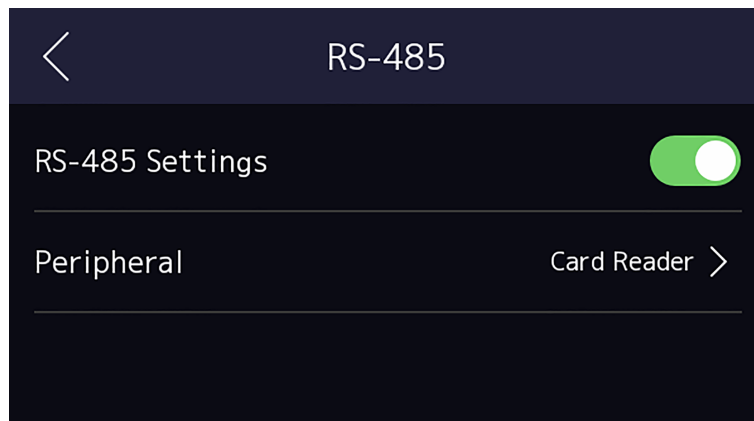

**Figure 7-6 Set RS-485 Parameters**

3. Select an peripheral type according to your actual needs.

---

## Note

If you select **Access Controller**: If connect the device to a terminal via the RS-485 interface, set the RS-485 address as 2. If you connect the device to a controller, set the RS-485 address according to the door No.

---

4. Tap the back icon at the upper left corner and you should reboot the device if you change the parameters.

## 7.2.4 Set Wiegand Parameters

You can set the Wiegand transmission direction.

### Steps

1. Tap **System** → **Comm.** (Communication Settings) on the Home page to enter the Communication Settings page.
2. On the Communication Settings page, tap **Wiegand** to enter the Wiegand tab.
3. Enable the Wiegand function.
4. Select a transmission direction.
  - Output: A face recognition terminal can connect an external access controller. And the two devices will transmit the card No. via Wiegand 34.
  - Input: A face recognition terminal can connect a Wiegand card reader.
5. Tap  to save the network parameters.



If you change the external device, and after you save the device parameters, the device will reboot automatically.

---

## 7.2.5 Set ISUP Parameters

Set ISUP parameters and the device can upload data via ISUP protocol.

### Before You Start

Make sure your device has connect to a network.

### Steps

1. Tap **System** → **Comm.** → **ISUP** (Communication Settings) on the Home page to enter the settings page.

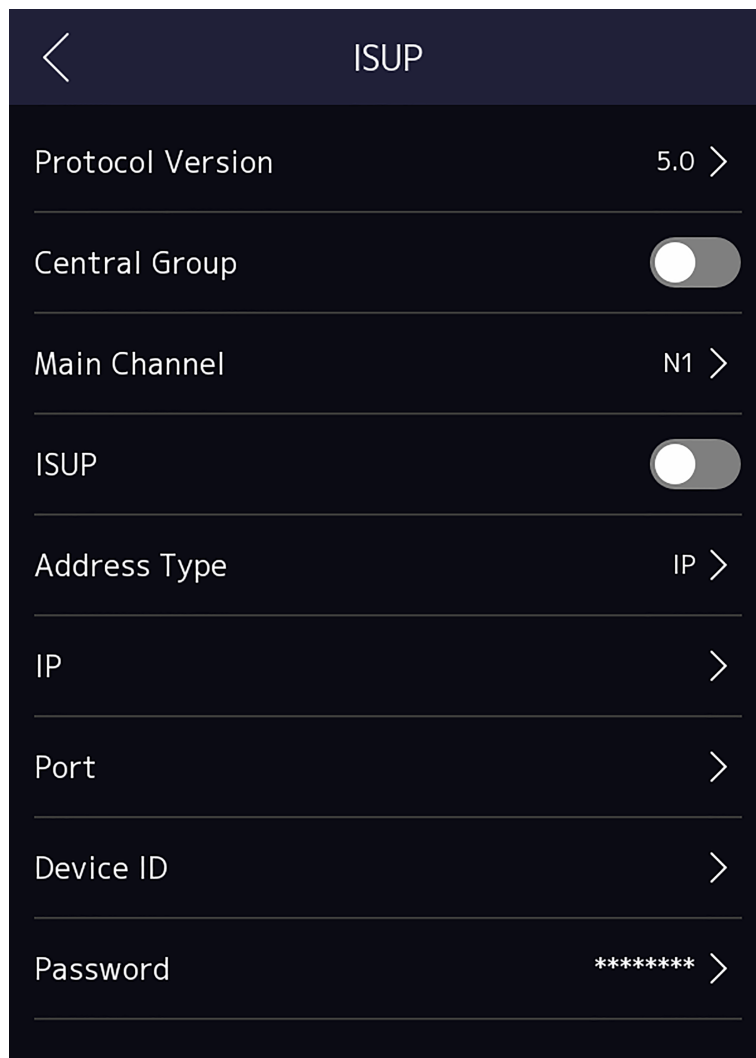

**Figure 7-7 ISUP Settings**

2. Enable the ISUP function and set the ISUP server parameters.

**ISUP Version**

Set the ISUP version according to your actual needs.

**Central Group**

Enable central group and the data will be uploaded to the center group.

**Main Channel**

Support N1 or None.

**ISUP**

Enable ISUP function and the data will be uploaded via ISUP protocol.

**Address Type**

Select an address type according to your actual needs.

### IP Address

Set the ISUP server's IP address.

### Port No.

Set the ISUP server's port No.

---



#### Note

Port No. Range: 0 to 65535.

---

### Device ID

Set device serial no.

### Password

If you choose V5.0, you should create an account and ISUP key. If you choose other version, you should create an ISUP account only.

---



#### Note

- Remember the ISUP account and ISUP key. You should enter the account name or the key when the device should communicate with other platforms via ISUP protocol.
  - ISUP key range: 8 to 32 characters.
- 

## 7.2.6 Platform Access

You can change the device verification code and set the server address before you add the device to the Hik-Connect mobile client.

### Before You Start

Make sure your device has connected to a network.

### Steps

1. Tap **System** → **Comm.** (Communication Settings) on the Home page to enter the Communication Settings page.
2. On the Communication Settings page, tap **Access to Hik-Connect**.
3. Enable **Access to Hik-Connect**
4. Enter **Server IP**.
5. Create the **Verification Code**, and you need to enter the verification code when you manage the devices via **Hik-Connect**.

## 7.3 Person Management

On the person management interface, you can add, edit, delete and search the person.

## 7.3.1 Add Administrator

The administrator can log in the device backend and configure the device parameters.

### Steps

1. Long tap on the initial page for 3 s and slide to the left/right by following the gesture and enter the device backend.
2. Tap **Person** → + to enter the Add Person page.

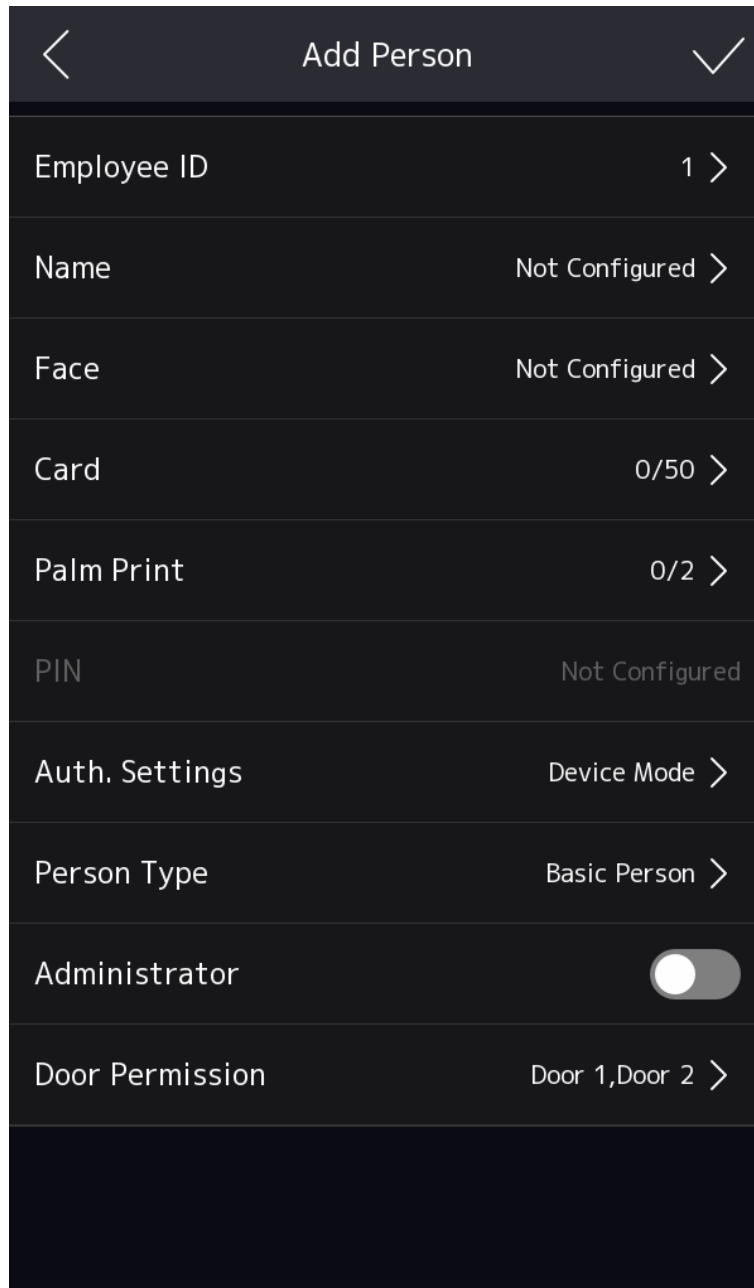

Employee ID	1 >
Name	Not Configured >
Face	Not Configured >
Card	0/50 >
Palm Print	0/2 >
PIN	Not Configured
Auth. Settings	Device Mode >
Person Type	Basic Person >
Administrator	<input type="checkbox"/>
Door Permission	Door 1, Door 2 >

### 3. Edit the employee ID.

---

#### Note

- The employee ID should be less than 32 characters. And it can be a combination of lower letters, upper letters, and numbers.
  - The employee ID should not be duplicated.
- 

### 4. Tap the Name field and input the person name on the soft keyboard.

---

#### Note

- Numbers, upper case letters, lower case letters, and special characters are allowed in the person name.
  - Up to 32 characters are allowed in the person name.
- 

### 5. **Optional:** Add a face picture, fingerprints, cards, PIN, palm print, keyfob for the administrator.

---

#### Note

- For details about adding a face picture, see [Add Face Picture](#) .
  - For details about adding a fingerprint, see [Add Fingerprint](#) .
  - For details about adding a card, see [Add Card](#) .
  - For details about adding a password, see [View PIN code](#) .
  - For details about adding a keyfob, see [Add Keyfob](#) .
  - For details about adding a palm print, see .
- 

### 6. **Optional:** Set the administrator's authentication type.

---

#### Note

For details about setting the authentication type, see [Set Authentication Mode](#) .

---

### 7. Enable the Administrator Permission function.

#### **Enable Administrator Permission**

The person is the administrator. Except for the normal attendance function, the person can also enter the Home page to operate after authenticating the permission.

### 8. Set **Door Permission**.

### 9. Tap to save the settings.

## 7.3.2 Import and Export Face and Person Data in Batch via Device

You can use the import and export function to import the data from device A to device B by USB flash drive.

#### **Before You Start**

- Login Device A (The device that you need to export data). For details, see [Login](#) .
- Insert an USB flash drive to Device A.



## Note

- The supported USB flash drive format is FAT32 or exFAT.
  - The system supports the USB flash drive with the storage of 1 G to 256 G. Make sure the free space of the USB flash drive is more than 512 M.
- 

## Steps

1. On Device A menu, tap **Data** and enter the **Data** page.

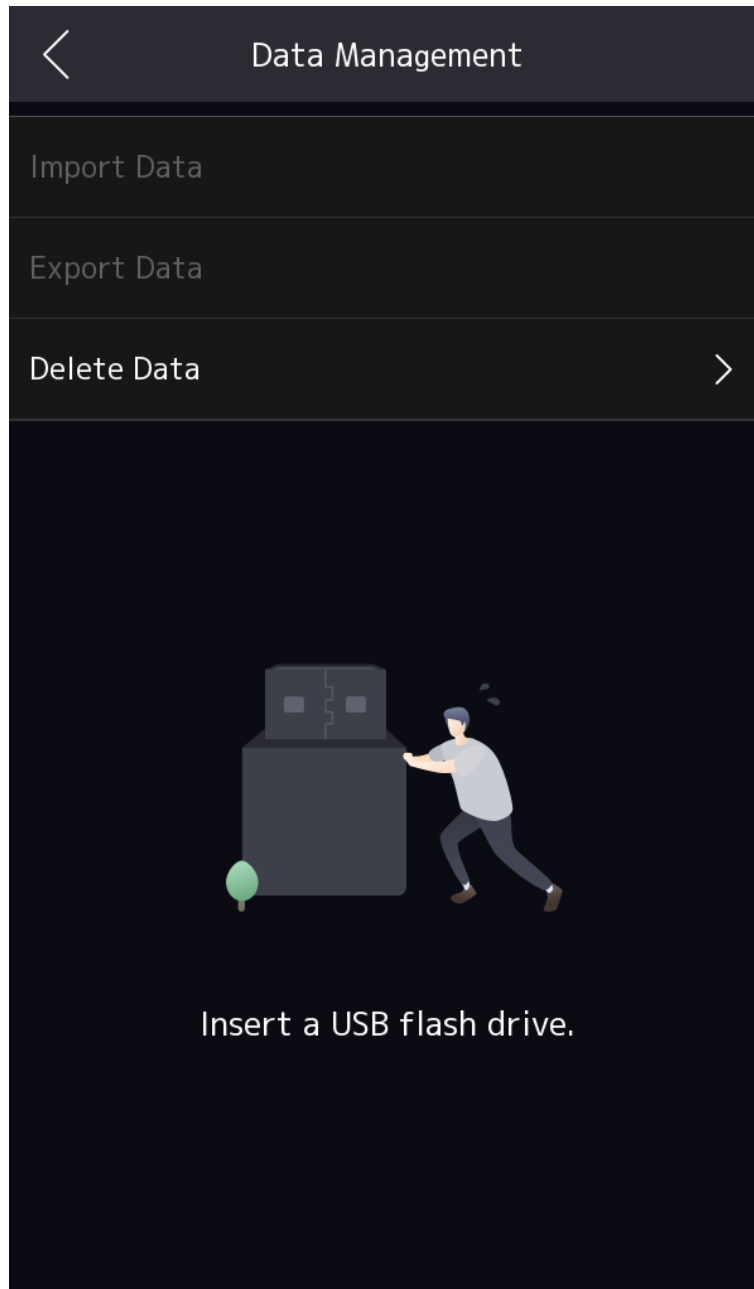

Figure 7-8 Data Management Page

2. Tap **Export Data** in the Data Management page.
3. Select **Person Data** or **Face Data**.
4. **Optional:** Create a password for exporting. When you import those data to another device, you should enter the password.

---

 **Note**

- The password cannot be empty. If you do not set a password, you can view the exported data in your PC.
- If you set a password, you cannot view the exported data in your PC.
- The exported person data is a DB file, which cannot be edited.

5. Insert the USB flash drive to Device B that need to import face and person data.

---

 **Note**

Make sure the two device are of the same device type.

6. On Device B menu, tap **Data** and enter the **Data** page.
7. Tap **Import Data**.
8. Select **Person Data** or **Face Data**.
9. Enter the created password when you exported the data. If you do not create a password when you exported the data, leave a blank in the input box and tap **OK**. The data will be imported from USB flash drive.

---

 **Note**

- If you need to import pictures manually, you should save the pictures in the root directory (enroll\_pic) of the USB flash drive. The picture's name should be follow the rule below: Card No. \_Name\_ Department\_ Employee ID\_ Gender.jpg For gender, 3 refers to male, 6 refers to female, and 0 refers to none. The employee ID should be less than 32 characters. The name should be less than 20 characters, and the card No. should be less than 20 characters.
- Up to 10,000 pictures can be saved in the Enroll\_pic folder. If the folder enroll\_pic cannot save all imported pictures, you can create another folders, named enroll\_pic1, enroll\_pic2, enroll\_pic3, enroll\_pic4, under the root directory. Up to 10 folders can be added. The picture name should follow the picture naming rule.
- Requirements of face picture should follow the rules below: It should be taken in full-face view, directly facing the camera. Do not wear a hat or head covering when taking the face picture. The format should be JPEG or JPG. The resolution should be 640 × 480 pixel or more than of 640 × 480 pixel. The picture size should be between 60 KB and 200 KB.

---

### 7.3.3 Add Face Picture

Add person's face picture to the device. And the person can use the face picture to authenticate.

#### Steps

1. Long tap on the initial page for 3 s and slide to the left/right by following the gesture and log in the backend.

2. Tap **Person** → **+** to enter the Add Person page.
3. Edit the employee ID.

---

 **Note**

- The employee ID should be less than 32 characters. And it can be a combination of lower letters, upper letters, and numbers.
- The employee ID should not be duplicated.

- 
4. Tap the Name field and input the person name on the soft keyboard.

---

 **Note**

- Numbers, upper case letters, lower case letters, and special characters are allowed in the person name.
- The suggested person name should be within 32 characters.

- 
5. Tap the Face Picture field to enter the face picture adding page.

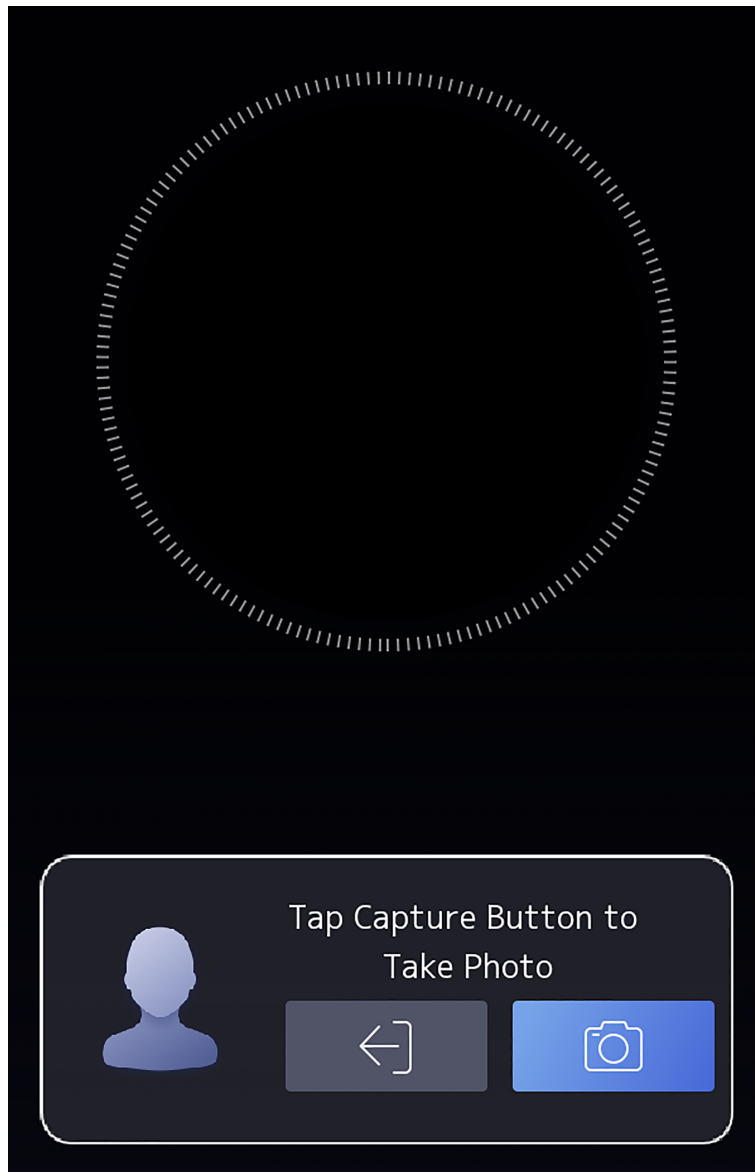

**Figure 7-9 Add Face Picture**

6. Look at the camera.

---

 **Note**

- Make sure your face picture is in the face picture outline when adding the face picture.
- Make sure the captured face picture is in good quality and is accurate.
- For details about the instructions of adding face pictures, see ***Tips When Collecting/Comparing Face Picture*** .

---

After completely adding the face picture, a captured face picture will be displayed at the upper right corner of the page.

7. Tap **Save** to save the face picture.

8. **Optional:** Tap **Try Again** and adjust your face position to add the face picture again.

9. Set the person type.

### Basic Person

The person is the normal person. The person can only authenticate or take attendance on the initial page. You can also set the basic person as an **Administrator** by enable the administrator function.

### Visitor

The person is a visitor.

### Person in Blocklist

The person is in the blocklist. When the person starts authentication, an event will be upload.

### Custom Type

Set the custom person type.

10. Tap  to save the settings.

## 7.3.4 Add Card

Add a card for the person and the person can authenticate via the added card.

### Steps

---

#### **Note**

Each person can add up to 50 cards.

---

1. Long tap on the initial page for 3 s and slide to the left/right by following the gesture and log in the backend.
  2. Tap **person** → **+** to enter the Add Person page.
  3. Connect an external card reader according to the wiring diagram.
  4. Tap the Employee ID. field and edit the employee ID.
- 

#### **Note**

- The employee ID should be less than 32 characters. And it can be a combination of lower letters, upper letters, and numbers.
  - The employee ID should not be duplicated.
- 

5. Tap the Name field and input the person name on the soft keyboard.
- 

#### **Note**

- Numbers, upper case letters, lower case letters, and special characters are allowed in the person name.
  - The suggested person name should be within 32 characters.
- 

6. Tap the Card field and tap **+**.
-

### 7. Configure the card No.

- Enter the card No. manually.
- Present the card over the card presenting area to get the card No.

---

#### Note

- The card No. cannot be empty.
- Up to 20 characters are allowed in the card No.
- The card No. cannot be duplicated.

---

### 8. Configure the card type.

### 9. Tap to save the settings.

## 7.3.5 Add Fingerprint

Add a fingerprint for the person and the person can authenticate via the added fingerprint.

### Steps

---

#### Note

The function should be supported by the device.

1. Long tap on the initial page for 3 s and slide to the left/right by following the gesture and enter the device backend.
2. Tap **Person** → **+** to enter the Add Person page.
3. Tap the Employee ID. field and edit the employee ID.

---

#### Note

- The employee ID should be less than 32 characters. And it can be a combination of lower letters, upper letters, and numbers.
- The employee ID should not start with 0 and should not be duplicated.

- 
4. Tap the Name field and input the person name on the soft keyboard.

---

#### Note

- Numbers, upper case letters, lower case letters, and special characters are allowed in the person name.
- The suggested person name should be within 32 characters.

- 
5. Tap the Fingerprint field to enter the Add Fingerprint page.
  6. Follow the instructions to add a fingerprint.

---

#### Note

- The same fingerprint cannot be repeatedly added.
- Up to 10 fingerprints can be added for one person.
- You can also use the client software or the fingerprint recorder to record fingerprints.

For details about the instructions of scanning fingerprints, see [\*Tips for Scanning Fingerprint\*](#) .

7. Tap  to save the settings.

### 7.3.6 View PIN code

Add a PIN code for the person and the person can authenticate via the PIN code.

#### Steps

1. Long tap on the initial page for 3 s and slide to the left/right by following the gesture and log in the backend.
2. Tap **Person** → + to enter the Add Person page.
3. Tap the Employee ID. field and edit the employee ID.

---

#### Note

- The employee ID should be less than 32 characters. And it can be a combination of lower letters, upper letters, and numbers.
- The employee ID should not be duplicated.

4. Tap the Name field and input the person name on the soft keyboard.

---

#### Note

- Numbers, upper case letters, lower case letters, and special characters are allowed in the person name.
- The suggested person name should be within 32 characters.

5. Tap the PIN code to view the PIN code.

---

#### Note

The PIN code cannot be edited. It can only be applied by the platform.

6. Tap  to save the settings.

### 7.3.7 Add Keyfob

Add a keyfob for the user.

#### Steps

---

#### Note

- The function should be supported by the device.
- Each person can add up to one keyfob, and the device can add up to 5,000 keyfobs.

1. Long tap on the initial page for 3 s and slide to the left/right by following the gesture and enter the device backend.
2. Tap **User** → + to enter the Add User page.
3. Tap the Employee ID. field and edit the employee ID.

---

### Note

- The employee ID should be less than 32 characters. And it can be a combination of lower letters, upper letters, and numbers.
- The employee ID should not start with 0 and should not be duplicated.

---

4. Tap the Name field and input the user name on the soft keyboard.

---

### Note

- Numbers, upper case letters, lower case letters, and special characters are allowed in the user name.
- The suggested user name should be within 32 characters.

---

5. Tap **Keyfob** → + → **Keyfob Serial No.** , and enter the serial No., and tap **OK**. Press and hold keys in the upper left and lower right corners of keyfob for 10 s to pair with face recognition terminal.

---

### Note

The keyfob serial No. starts with Q-Z followed by 8-digit Arabic numerals.

---

6. Tap  to save the settings.

---

### 7.3.8 Add Palm Print and Palm Vein

Add a palm print for the person and the person can authenticate via the added palm print.

#### Steps

---

### Note

- The function should be supported by the device.
  - Up to 10000 palm print and palm vein can be added.
- 

1. Long tap on the initial page for 3 s and slide to the left/right by following the gesture and enter the device backend.
  2. Tap **Person** → + to enter the Add Person page.
  3. Tap the Employee ID. field and edit the employee ID.
- 

### Note

- The employee ID should be less than 32 characters. And it can be a combination of lower letters, upper letters, and numbers.
  - The employee ID should not start with 0 and should not be duplicated.
- 

4. Tap the Name field and input the person name on the soft keyboard.

---



---

### Note

- Numbers, upper case letters, lower case letters, and special characters are allowed in the person name.
- The suggested person name should be within 32 characters.

- 
5. Tap **Palm Print**, and tap **+** to enter the adding page.
  6. Place the palm at a distance of 5 ~ 12 cm from the peripheral module of the device.
  7. Tap  to save the settings.

### 7.3.9 Set Person Type via Device

Set the person type as basic person, visitor, person in blocklist, or custom person type.

#### Before You Start

Login the device. For details, see [Login](#) .

#### Steps

1. Tap **Person** → **+**.

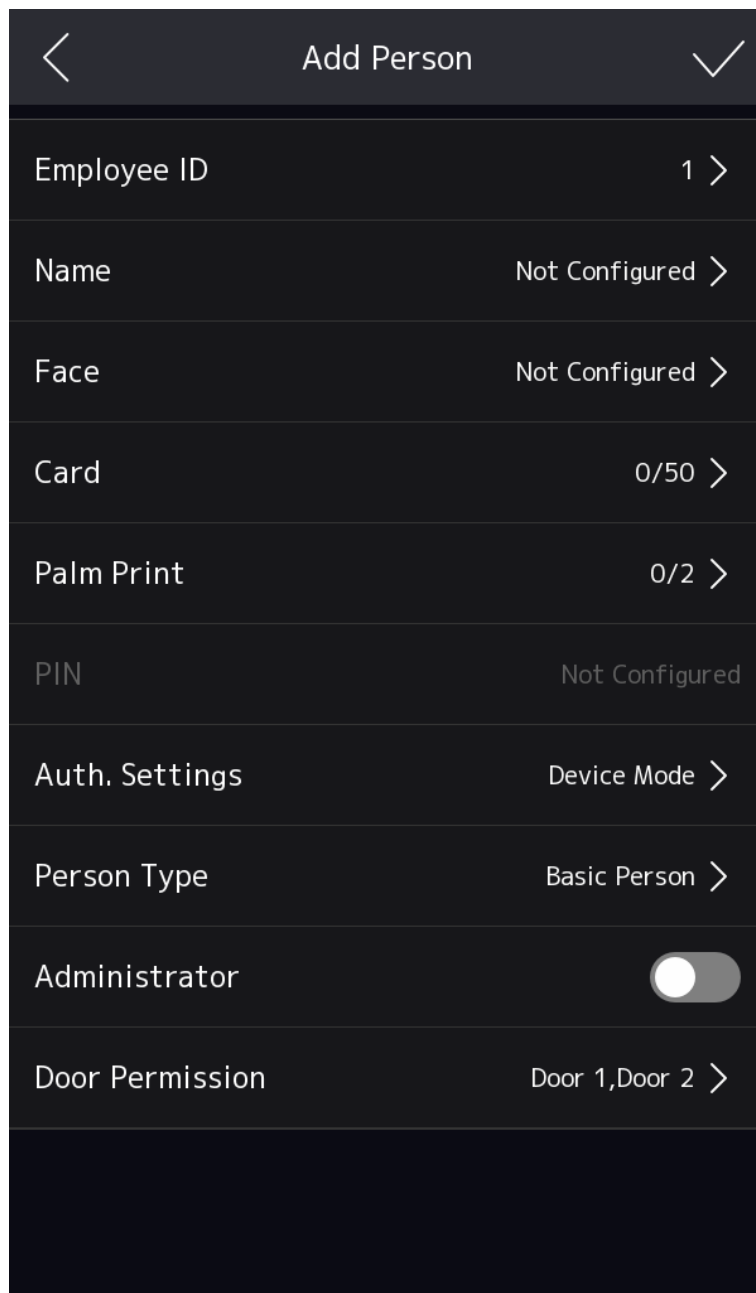

**Figure 7-10 Add Person**

2. Tap **Employee ID** and you can edit the Employee ID.

---

 **Note**

The employee ID cannot be more than 32 characters. It can be a combination of upper case letters, lower case letters, and digits.

3. Tap **Name** and create a name. Enter the person's name according to the pop-up keyboard.

---

### Note

- The name supports digits, upper case letters, lower case letters, and special characters.
- The name should be within 128 characters.

---

#### 4. Set the face, card, fingerprint, and palm print.

---

### Note

- Refers to ***Add Face Picture*** , ***Add Card*** , ***Add Fingerprint*** , and to add face, card, fingerprint and palm print.
- Only device with fingerprint or palm modules supports the fingerprint or palm functions.

---

#### 5. Tap **Person Type** and set the type as **Basic Person**, **Visitor**, **Person in Blocklist**, or **Custom Type**.

---

### Note

- When setting the person to visitor, administrator cannot be set. When setting the person to person in blocklist, the door permission cannot be configured.
- You should set the name of the custom type on PC web. After naming the custom type, the custom type on the device will be change to the named one. For detailed settings, see ***Person Management*** .

---

#### 6. Tap to save the settings.

### 7.3.10 Set Authentication Mode

After adding the person's face picture, password, or other credentials, you should set the authentication mode and the person can authenticate his/her identity via the configured authentication mode.

#### Steps

1. Long tap on the initial page for 3 s and slide to the left/right by following the gesture and log in the backend.
2. Tap **Person** → **Add Person/Edit Person** → **Authentication Mode** .
3. Select Device or Custom as the authentication mode.

#### Device

If you want to select device mode, you should set the terminal authentication mode in Access Control Settings page first. For details see *Setting Access Control Parameters*.

#### Custom

You can combine different authentication modes together according to your actual needs.

4. Tap  to save the settings.

### 7.3.11 Search and Edit Person

After adding the person, you can search the person and edit it.

### Search Person

On the Person Management page, Tap the search area to enter the Search Person page. Tap **Card** on the left of the page and select a search type from the drop-down list. Enter the employee ID, card No., or the person name for search. Tap  to search.

### Edit Person

On the Person Management page, select a person from the person list to enter the Edit Person page. Follow the steps in [\*\*\*Person Management\*\*\*](#) to edit the person parameters. Tap  to save the settings.



#### Note

The employee ID cannot be edited.

---

### 7.3.12 Set Person Door Permission via Device

Set the normal person or visitor's permission of passing door.

#### Before You Start

Login the device. For details, see [\*\*\*Login\*\*\*](#) .

#### Steps

1. Tap **Person** → +.

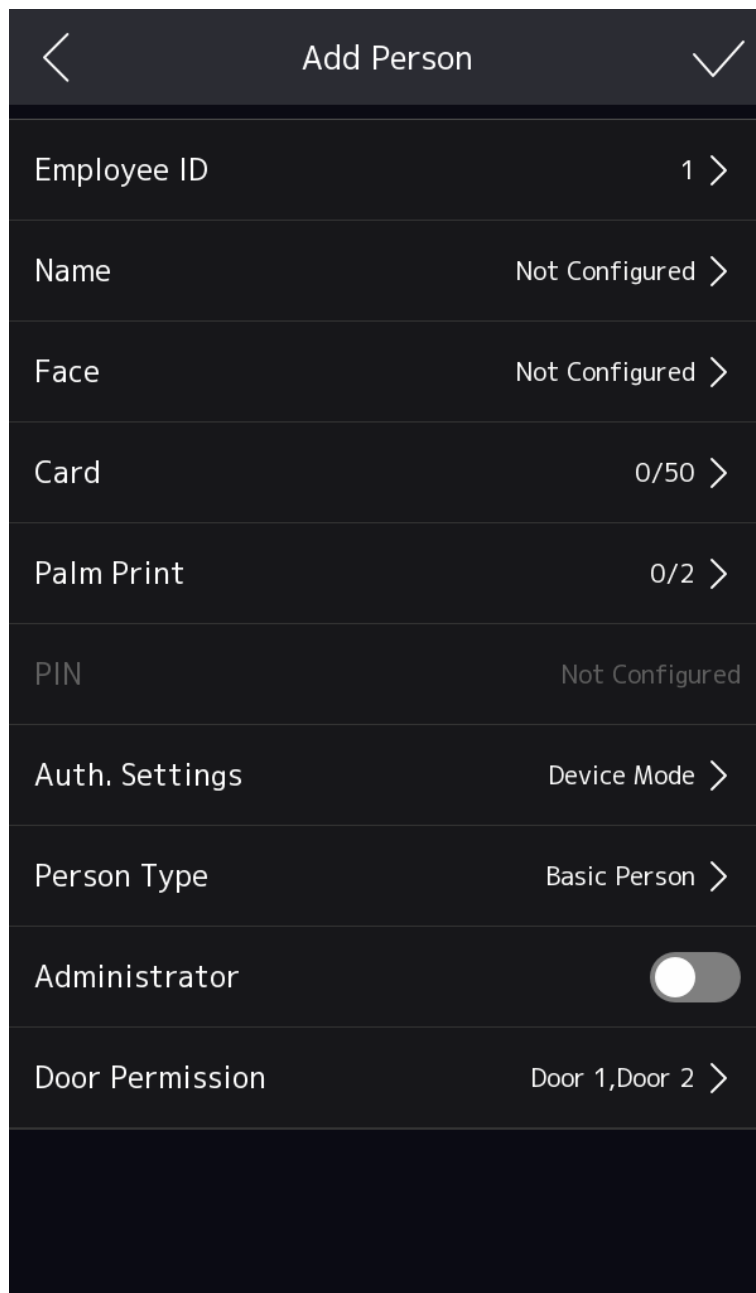

**Figure 7-11 Add Person**

2. Tap **Employee ID** and you can edit the Employee ID.

---

 **Note**

The employee ID cannot be more than 32 characters. It can be a combination of upper case letters, lower case letters, and digits.

3. Tap **Name** and create a name. Enter the person's name according to the pop-up keyboard.

---

## Note

- The name supports digits, upper case letters, lower case letters, and special characters.
- The name should be within 128 characters.

---

4. Set the face, card, fingerprint, and palm print.

---

## Note

- Refers to **Add Face Picture** , **Add Card** , **Add Fingerprint** , and to add face, card, fingerprint and palm print.
- Only device with fingerprint or palm modules supports the fingerprint or palm functions.

---

5. Tap **Person Type** and set the type as **Basic Person** or **Visitor**.

---

## Note

When setting the person to visitor, administrator cannot be set. If set the person as person in blocklist, you cannot configure the door permission for the person.

---

6. Tap **Door Permission**, and select a door for the person to pass. Door 1 means that the door is connected to the device. Door 2 means the door is connected to the secure door control unit.

---

## Note

When remote authentication, the administrator can judge the door to open according to the person's door permission.

---

7. Tap  to save the settings.

## 7.4 Data Management

You can delete data, import data, and export data.

### 7.4.1 Delete Data

Delete person data.

On the Home page, tap **Data** → **Delete Data** → **Person Data** . All person data added in the device will be deleted.

### 7.4.2 Import Data

#### Steps

1. Plug a USB flash drive in the device.
2. On the Home page, tap **Data** → **Import Data** .
3. Tap **Person Data**, **Face Data** or **Access Control Parameters** .

---

 **Note**

The imported access control parameters are configuration files of the device.

4. Enter the created password when you exported the data. If you do not create a password when you exported the data, leave a blank in the input box and tap **OK** immediately.

---

 **Note**

- If you want to transfer all person information from one device (Device A) to another (Device B), you should export the information from Device A to the USB flash drive and then import from the USB flash drive to Device B. In this case, you should import the person data before importing the profile photo.
  - The supported USB flash drive format is FAT32.
  - The imported pictures should be saved in the folder (named enroll\_pic) of the root directory and the picture's name should be follow the rule below:  
Card No. \_Name\_ Department\_ Employee ID\_ Gender.jpg
  - If the folder enroll\_pic cannot save all imported pictures, you can create another folders, named enroll\_pic1, enroll\_pic2, enroll\_pic3, enroll\_pic4, under the root directory.
  - The employee ID should be less than 32 characters. It can be a combination of lower letters, upper letters, and numbers. It should not be duplicated, and should not start with 0.
  - Requirements of face picture should follow the rules below: It should be taken in full-face view, directly facing the camera. Do not wear a hat or head covering when taking the face picture. The format should be JPEG or JPG. The resolution should be 640 × 480 pixel or more than of 640 × 480 pixel. The picture size should be between 60 KB and 200 KB.
- 

## 7.4.3 Export Data

### Steps

1. Plug a USB flash drive in the device.
2. On the Home page, tap **Data → Export Data** .
3. Tap **Face Data, Event Data, Person Data, or Access Control Parameters**.

---

 **Note**

The exported access control parameters are configuration files of the device.

4. **Optional:** Create a password for exporting. When you import those data to another device, you should enter the password.

---

 **Note**

- The supported USB flash drive format is DB.
  - The system supports the USB flash drive with the storage of 1 G to 256 G. Make sure the free space of the USB flash drive is more than 512M.
  - The exported person data is a DB file, which cannot be edited.
-

## 7.5 Person Authentication

After network configuration, system parameters configuration and user configuration, you can go back to the initial page for authentication. The system will authenticate person according to the configured authentication mode.

### 7.5.1 Authenticate via Single Credential

Set the user authentication type before authentication. For details, see [\*\*\*Set Authentication Mode\*\*\*](#).

#### Face

Face forward at the camera and start authentication via face.

#### Fingerprint

Place the enrolled fingerprint on the fingerprint module and start authentication via fingerprint.

#### Palm

Place the palm on the palm print module and start authentication via palm print.

#### Card

Present the card on the card presenting area and start authentication via card.



#### Note

The card can be normal IC card, or encrypted card.

---

#### QR Code

Put the QR code in front of the device camera to authenticate via QR code.



#### Note

- Authentication via QR code should be supported by the device.
  - You should enable QR code function in [\*\*\*Preference Settings\*\*\*](#).
- 

#### PIN

Enter the PIN to authenticate via PIN.

#### Keyfob

Press door-open button on the keyfob to authenticate.

If authentication completed, a prompt "Authenticated" will pop up.

### 7.5.2 Authenticate via Multiple Credential

#### Before You Start

Set the user authentication type before authentication. For details, see [\*\*\*Set Authentication Mode\*\*\*](#).



## Steps

1. Authenticate any credential according to the instructions on the live view page.
- 



- The card can be normal IC card, or encrypted card.
  - If the QR Code Scanning function is enabled, you can put the QR code in front of the device camera to authenticate via QR code.
- 

2. After the previous credential is authenticated, continue authenticate other credentials.
- 



- For detailed information about scanning fingerprint, see *Tips for Scanning Fingerprint*.
  - For detailed information about authenticating face, see *Tips When Collecting/Comparing Face Picture*.
- 

If authentication succeeded, the prompt "Authenticated" will pop up.

## 7.6 Basic Settings

Long tap on the initial page for 3 s and slide to the left/right by following the gesture and login the device home page. Tap **System** → **Basic** .

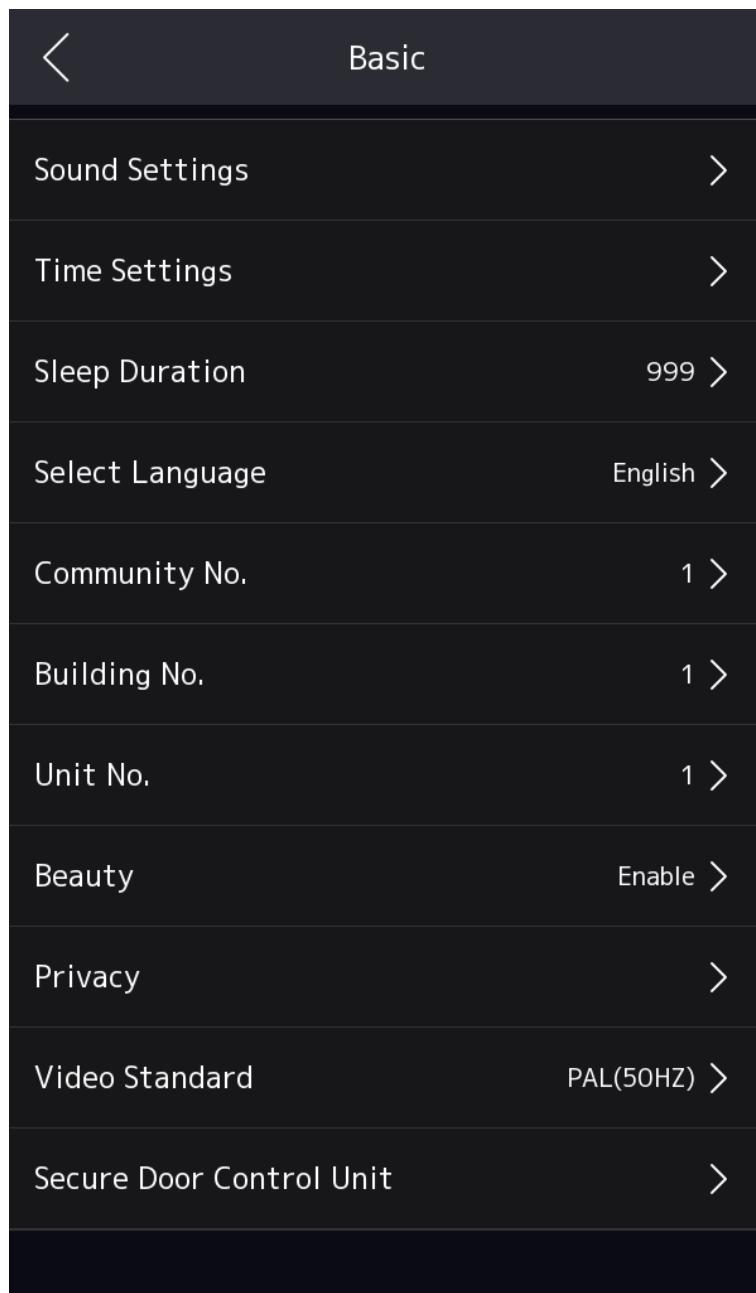

Figure 7-12 Basic Settings Page

### 7.6.1 Enable/Disable Voice Prompt via Device

You can enable/disable the voice prompt function and adjust the voice volume.

Login the device. For details, see [Login](#) .

Tap **System Settings** → **Basic** → **Sound Settings**.

You can enable **Voice Prompt** function and adjust the voice volume. Enable the voice prompt function and you can set the voice volume.

### 7.6.2 Set Device Time via Device

Set the device time.

Login the device. For details, see [Login](#) .

Tap **System Settings** → **Basic** → **Time Settings**.

Set the device time zone, current time, and DST.

### 7.6.3 Set Sleep Duration via Device

Set the device sleeping waiting time.

Login the device. For details, see [Login](#) .

Tap **System Settings** → **Basic**. And Set **Sleep Duration**.

When you are on the initial page and if you set the sleeping time to 30 s, the device will sleep after 30 s without any operation.



#### Note

If you set the sleeping time to 0, the device will not enter sleeping mode. The configurable sleep time is between 20 and 999s.

---

### 7.6.4 Select Language

Login the device. For details, see [Login](#) .

Tap **System Settings** → **Basic** . And tap **Select Language** to change the device language.

The device will reboot after changing the language.

### 7.6.5 Set Device Number via Device

The device can be used as access control device, door station, or outer door station. You can set the device number for video intercom.

Login the device. For details, see [Login](#) .

Tap **System Settings** → **Basic**. And set **Community No.**, **Building No.**, and **Unit No.**

### 7.6.6 Set Beauty via Device

You can enable the beauty function and set the smooth and the whiten parameter.

Login the device. For details, see [Login](#) .

Tap **System Settings** → **Basic** → **Beauty**.

Enable the beauty function and set the smooth and the whiten parameter. Tap + or - to control the effect strength.

### 7.6.7 Set Privacy Parameters via Device

Set the picture uploading parameters.



Different device models support different functions. Refers to actual model.

---

Login the device. For details, see [Login](#) .

Tap **System Settings** → **Basic** → **Privacy**.

### Authentication Settings

#### Name / Employee ID / Face Picture

You can choose to display/not display/desensitize name and Employ ID when authenticating.

### Picture Uploading and Storage

Set picture uploading and storage parameters.

#### Save Registered Pic.

The registered face picture will be saved to the system if you enable the function.

#### Save Pic. After Linked Capture

If you enable this function, you can save the picture after linked capture.

#### Upload Pic. After Linked Capture

Upload the pictures captured after linked capture.

#### Save Pic When Auth.

If you enable this function, you can save the picture when authenticating to the device.

#### Upload Pic. When Auth.

If you enable this function, you can save the picture when authenticating to the device.

#### Save Palm Print Picture

If you enable this function, you can save the picture when applying.

### 7.6.8 Set Video Standard

Set video standard for the live view.

Login the device. For details, see [Login](#) .

Go to **System** → **Basic** → **Video Standard**.

Set the video frame rate when performing live view remotely. After changing the standard, you should reboot the device to take effect.

### **PAL (50HZ)**

25 frames per second. Suitable for mainland China, Hong Kong (China), the Middle East countries, Europe countries, etc.

### **NTSC (60HZ)**

30 frames per second. Suitable for the USA, Canada, Japan, Taiwan (China), Korea, the Philippines, etc.

## **7.6.9 Set Secure Door Control Unit Parameters**

You can wire peripherals according to the secure door control unit. You can set to use door 1 or door 2 to control the secure door control unit.

### **Before You Start**

Device is wiring the secure door control unit by RS-485. For detailed wiring method, see [Wiring](#) .

### **Steps**

1. Login the device. For details, see [Login](#) .
2. Go to **System** → **Basic** → **Secure Door Control Unit**.
3. Select **Door 1** or **Door 2** as door No.



### **Note**

Door 1 means that the door will be controlled by secure door control unit. The same goes to the selection of door 2.

---

## **7.7 Set Face Parameters**

You can customize the face parameters to improve the face recognition performance.

Long tap on the initial page for 3 s and login the home page. Tap **System Settings** → **Biometrics** .

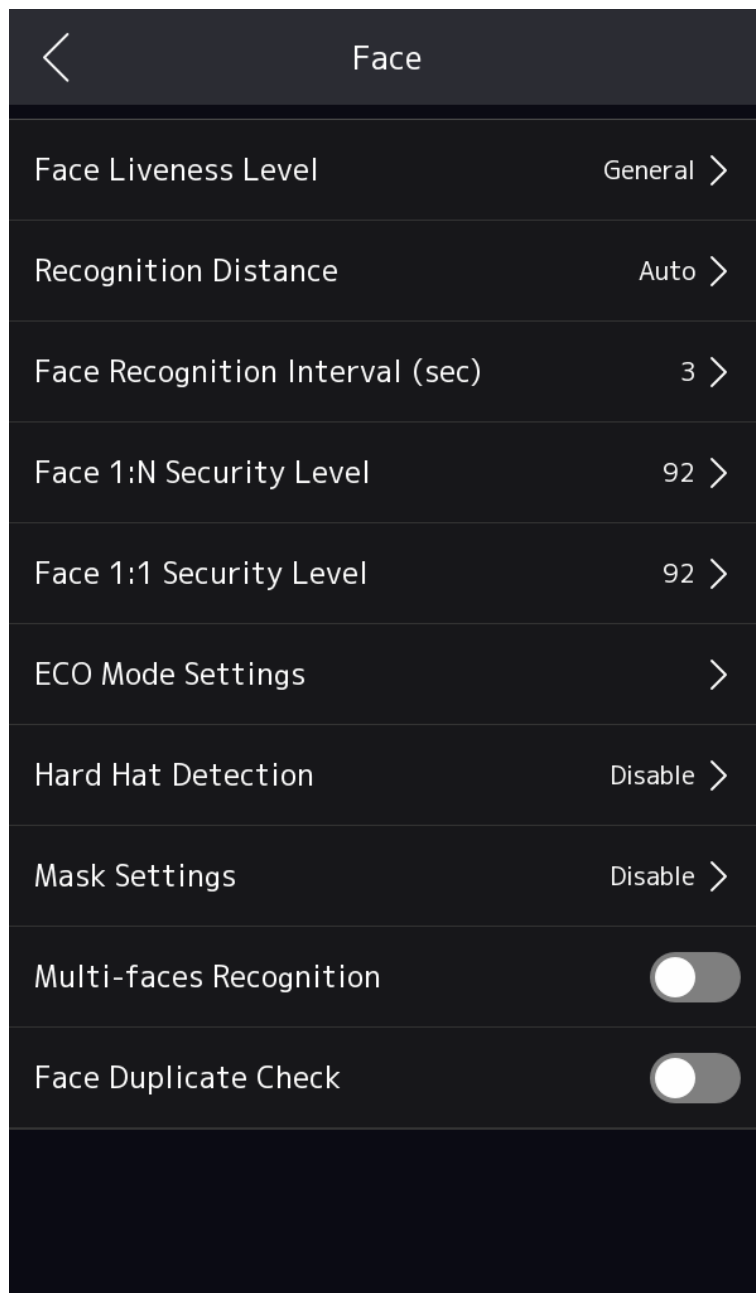

Figure 7-13 Face Settings

### 7.7.1 Set Face Liveness Level via Device

After enabling face anti-spoofing function, you can set the matching security level when performing live face authentication.

Login the device. For details, see [Login](#) .

Tap **System Settings** → **Biometrics** → **Face** .

Select a face liveness level.

You can select from general, advanced, and professional. The higher the level, the fault acceptance rate will be lower and the false rejection rate will be higher.

## 7.7.2 Set Recognition Distance via Device

Set the valid distance between the user and the camera when authenticating.

Login the device. For details, see [Login](#) .

Tap **System Settings** → **Biometrics** → **Face** → **Recognition Distance** .

Set the recognition distance.

## 7.7.3 Set Face Recognition Interval via Device

The time interval between two continuous face recognitions when authenticating.

Login the device. For details, see [Login](#) .

Tap **System Settings** → **Biometrics** → **Face** → **Face Recognition Interval (sec)** .

Set the face recognition interval.



### Note

Please enter a number between 1 and 10.

---

## 7.7.4 Set Face 1:N Security Level via Device

Set the matching threshold when authenticating via 1:N matching mode.

Login the device. For details, see [Login](#) .

Tap **System Settings** → **Biometrics** → **Face** → **Face 1:N Security Level** .

Set the matching threshold when authenticating via 1:N matching mode.

The larger the value of the threshold, the fault acceptance rate will be lower and the false rejection rate will be higher when authenticating via face. The maximum value is 100.

## 7.7.5 Set Face 1:1 Security Level via Device

Set the matching threshold when authenticating via 1:1 matching mode.

Login the device. For details, see [Login](#) .

Tap **System Settings** → **Biometrics** → **Face** → **Face 1: 1 Security Level** .

Set the matching threshold when authenticating via 1:1 matching mode.

The larger the value of the threshold, the fault acceptance rate will be lower and the false rejection rate will be higher when authenticating via face. The maximum value is 100.

### 7.7.6 Enable/Disable ECO Mode via Device

If the ECO mode is enabled, you can authenticate faces in the low light or dark environment with IR camera.

Login the device. For details, see [Login](#) .

Tap **System Settings** → **Biometrics** → **Face** → **ECO Mode Settings** .

If the ECO mode is enabled, you can authenticate faces in the low light or dark environment with IR camera. You can set the ECO mode threshold, ECO mode (1:N), and ECO mode (1:1).

#### ECO Mode Threshold

When enabling the ECO mode, you can set the ECO mode's threshold. The larger the value, the easier the device entering the ECO mode. The threshold has relationship with the illumination.

#### ECO Mode (1:1)

Set the matching threshold when authenticating via ECO mode 1:1 matching mode. The larger the value, the smaller the false accept rate and the larger the false rejection rate. The maximum value is 100.

#### ECO Mode (1:N)

Set the matching threshold when authenticating via ECO mode 1:N matching mode. The larger the value, the smaller the false accept rate and the larger the false rejection rate. The maximum value is 100.

### 7.7.7 Enable/Disable Hard Hat Detection via Device

After enabling the hard hat detection, when the device starts face authentication, the system will detection whether the person wearing a hard hat or not.

Login the device. For details, see [Login](#) .

Tap **System Settings** → **Biometrics** → **Face** → **Hard Hat Detection** .

#### Hard Hat Detection

After enabling the hard hat detection function, you can set the strategy of door opening.

##### None

If the person do not wear a face mask when authenticating, the device will not prompt a notification.

##### Reminder of Wearing

If the person do not wear the hard hat when authenticating, the device will pop up a prompt and the door will open.



### **Must Wear**

If the person do not wear the hard hat when authenticating, the device will pop up a prompt and the door will keep closed.

### **7.7.8 Enable/Disable Mask Detection via Device**

After enabling the face with mask detection, the system will recognize the captured face with mask picture.

Login the device. For details, see [Login](#) .

Tap **System Settings** → **Biometrics** → **Face** → **Mask Settings**.

After enabling the face with mask detection, the system will recognize the captured face with mask picture. You can set **Face with Mask & Face (1:1)**、**Face with Mask & Face (1:N)**、**ECO Mode (1:1) Threshold**、**ECO Mode (1:N) Threshold**, and **Prompt Method**.

#### **Face with Mask & Face (1:1)**

Set face with mask 1:1 matching threshold. The larger the value, the smaller the false accept rate and the larger the false rejection rate. The maximum value is 100.

#### **Face with Mask & Face (1:N)**

Set face with mask 1:N matching threshold. The larger the value, the smaller the false accept rate and the larger the false rejection rate. The maximum value is 100.

#### **ECO Mode (1:1) Threshold**

After enabling the ECO mode, you can set the face with mask function. You can set the threshold.

Set the matching threshold when authenticating via ECO mode 1:1 matching mode. The larger the value of the threshold, the fault acceptance rate will be lower and the false rejection rate will be higher when authenticating via face. The maximum value is 100.

#### **ECO Mode (1:N) Threshold**

After enabling the ECO mode, you can set the face with mask function. You can set the threshold.

Set the matching threshold when authenticating via ECO mode 1:N matching mode. The larger the value of the threshold, the fault acceptance rate will be lower and the false rejection rate will be higher when authenticating via face. The maximum value is 100.

### **Strategy**

Set **None**、**Reminder of Wearing**, and **Must Wear**.

#### **None**

If the person do not wear a face mask when authenticating, the device will not prompt a notification.

#### **Reminder of Wearing**

If the person do not wear a face mask when authenticating, the device prompts a notification and the door will open.

### **Must Wear**

If the person do not wear a face mask when authenticating, the device prompts a notification and the door keeps closed.

### **7.7.9 Enable/Disable Multi-Faces Recognition**

After multiple faces authentication is enabled, multiple faces authentication is supported.

Login the device. For details, see [Login](#) .

Tap **System Settings** → **Biometrics** → **Face**.

Enable **Multi-faces Recognition**. After the function is enabled, multiple faces can authenticate at the same time.



#### **Note**

- Up to 5 persons can authentication at the same time.
  - After the function is enabled, card reader authentication mode, custom authentication, attendance status, manually trigger authentication via face cannot be used.
- 

### **7.7.10 Face Duplicate Check via Device**

After enabling the face duplicate check function, when adding person's face, the system will check the duplication. If there is duplicated face picture detected in the system, a prompt will be pop up.



#### **Note**

The function is not supported in remote adding or applying face picture in batch.

---

Login the device. For details, see [Login](#) .

Tap **System Settings** → **Biometrics** → **Face** .

Enable **Face Duplicate Check**. After enabling the function, when adding person's face, the system will check the duplication. If there is duplicated face picture detected in the system, a prompt will be pop up.

### **7.7.11 Set Palm Print**

You can set palm print recognition timeout threshold and palm print recognition interval .

Login the device. For details, see [Login](#) .

Tap **System Settings** → **Biometrics** → **Palm Print** .

Set **Palm Print Recognition Timeout Threshold** and **Palm Print Recognition Interval**.

## 7.8 Access Control Settings

You can set the access control permissions.

On the Home page, tap **ACS** to enter the Settings page.

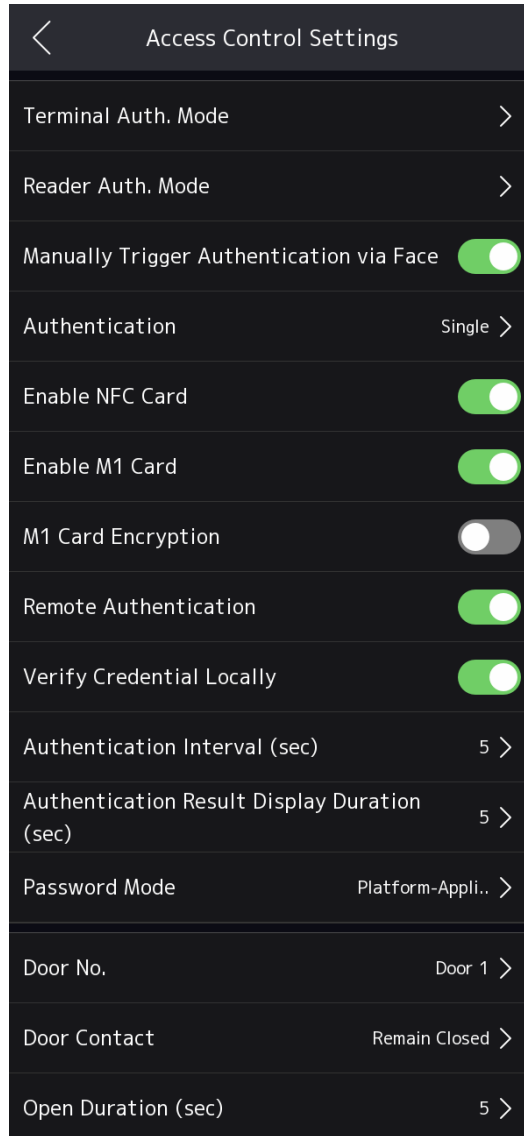

**Figure 7-14 Access Control Settings**

### 7.8.1 Set Terminal Authentication Mode via Device

Select the face recognition terminal's authentication mode. You can select different combination to authenticate.

Login the device. For details, see [Login](#) .

Tap **ACS → Terminal Auth. Mode** .

Select person authentication type and method and save the settings.

If all persons on the device's authentication mode is **Device Mode**, all persons on the device will use the device authentication mode. For detail about person authentication mode settings, see [Set Authentication Mode](#) .

---



Device with fingerprint module supports fingerprint function.

---

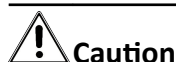

Biometric recognition products are not completely applicable to anti-spoofing environments. If you require a higher security level, use multiple authentication modes.

---

### 7.8.2 Set Reader Authentication Mode via Device

Set the person authentication type on the wired external reader. You can select different combination to authenticate.

Login the device. For details, see [Login](#) .

Tap **ACS → Reader Auth. Mode** .

Select person authentication type and save the settings.

Select person authentication type and method and save the settings.

If all persons on the device's authentication mode is **Device Mode**, all persons on the device will use the device authentication mode. For detail about person authentication mode settings, see [Set Authentication Mode](#) .

---



Device with fingerprint module supports fingerprint function.

---

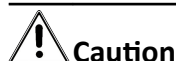

Biometric recognition products are not completely applicable to anti-spoofing environments. If you require a higher security level, use multiple authentication modes.

---

### 7.8.3 Manually Trigger Face Authentication via PC Web

After enabling Manually Trigger Authentication via Face, you need to touch the screen of the device manually for face recognition.

Login the device. For details, see [Login](#) .

Tap **ACS**.

---

Enable **Manually Trigger Authentication via Face**, and set **Authentication** as **Single** or **Continuous Single**

The person should tap **Authentication** on the authentication page manually to trigger recognition before each face recognition.

### **Continuous**

After triggering the recognition, you can recognize via face until the device enter into the sleeping mode.

## **7.8.4 Enable/Disable NFC Card**

Enable/disable NFC card function.

After login, tap **ACS**.

Tap **Enable NFC**. After enabling, the device can read NFC card.



### **Note**

When the dual-frequency card module access to the face recognition terminal, swiping the card on the device is invalid.

---

## **7.8.5 Enable/Disable M1 Card**

Enable or disable M1 card function.

Login the device. For details, see [Login](#) .

After login, tap **ACS**.

Tap **Enable M1 Card**, and the device can read M1 card.

### **Enable M1 Card**

After enabling, the device can read M1 card.

### **M1 Card Encryption**

After enabling M1 Card Encryption, the device will verify the M1 card sector. Go to the platform to set the M1 card's encryption sector.



### **Note**

When the dual-frequency card module access to the face recognition terminal, swiping the card on the device is invalid.

---

## **7.8.6 Remote Authentication**

Judge the authentication passes or not by remote platforms.

Login the device. For details, see [Login](#) .

Tap **ACS**.

Enable **Remote Authentication**. When there's a person is authenticating, the remote platform will judge to pass or not.

Authenticate the credential on the device and verify by the platform.

You can also enable **Verify Credential Locally** and the verification will be produced on the device.

### 7.8.7 Set Authentication Interval via Device

Login the device. For details, see [Login](#) .

Tap **ACS**, and set **Authentication Interval** and save.

You can set the authentication interval of the same person when authenticating. The same person can only authenticate once in the configured interval. A second authentication will be failed.

Available authentication interval range: 0 to 65535.

### 7.8.8 Set Authentication Result Display Duration via Device

Set the authentication result display duration when authenticating.

Login the device. For details, see [Login](#) .

Tap **ACS**, and set **Authentication Result Display Duration** and save.

### 7.8.9 Set Password Mode

You can set the password mode and choose whether to edit password on device / PC web, or platform.

#### Steps

1. Login the device. For details, see [Login](#) .
2. Tap **ACS**.
3. Tap **Password Mode** and set the mode.

#### **Platform-Applied Personal PIN**

The PIN is managed and distributed by the platform after the device accesses the platform.

#### **Device-Set Personal PIN**

The PIN is set on the device or PC Web.

4. Go back to the previous page to save the settings.

### 7.8.10 Door Parameter Configuration

Configure parameters for unlocking doors.

## Set Door No. via Device

Select a door No. for the device.

Login the device. For details, see [Login](#) .

After login, tap **ACS**.

Tap **Door No.**. Select **Door 1** or **Door 2**.

The door 1 means the device installed at the entrance. Door 2 means the device installed at the exit.

## Set Door Contact via Device

Select door contact status according to the door contact's wiring method.

Login the device. For details, see [Login](#) .

Tap **ACS**.

You can select Remain Open or Remain Closed according to your actual needs. By default, it is Remain Closed.

## Set Open Duration via Device

Set the door unlocking duration.

Login the device. For details, see [Login](#) .

Tap **ACS**.

Set the door unlocking duration. If the door is not opened for the set time, the door will be locked. Available door locked time range: 1 to 255s.

## 7.9 Platform Attendance

You can set the attendance mode as check in, check out, break out, break in, overtime in, and overtime out according to your actual situation.



The function should be used cooperatively with time and attendance function on the client software.

---

### 7.9.1 Disable Attendance Mode via Device

Disable the attendance mode and the system will not display the attendance status on the initial page.

Tap **Platform Attendance** to enter the T&A Status page.

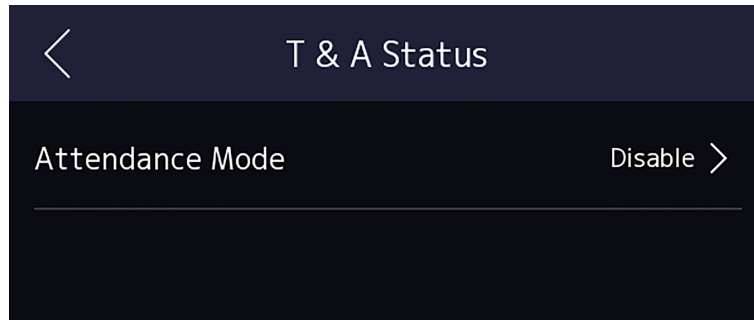

**Figure 7-15 Disable Attendance Mode**

Set the **Attendance Mode** as **Disable**.

You will not view or configure the attendance status on the initial page. And the system will follow the attendance rule that configured on the platform.

## 7.9.2 Set Manual Attendance via Device

Set the attendance mode as manual, and you should select a status manually when you take attendance.

### Before You Start

Add at least one user, and set the user's authentication mode. For details, see *User Management*.

### Steps

1. Tap **Platform Attendance** to enter the T&A Status page.
2. Set the **Attendance Mode** as **Manual**.



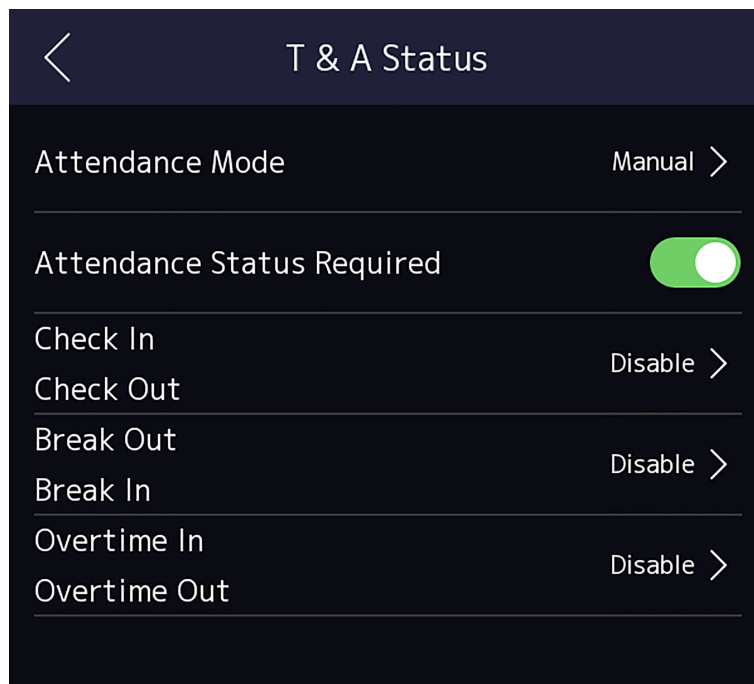

**Figure 7-16 Manual Attendance Mode**

3. Enable the **Attendance Status Required**.
4. Enable a group of attendance status.

---

 **Note**

The Attendance Property will not be changed.

5. **Optional:** Select an status and change its name if required.  
The name will be displayed on the T & A Status page and the authentication result page.

**Result**

You should select an attendance status manually after authentication.

---

 **Note**

If you do not select a status, the authentication will be failed and it will not be marked as a valid attendance.

---

### 7.9.3 Set Auto Attendance via Device

Set the attendance mode as auto, and you can set the attendance status and its available schedule. The system will automatically change the attendance status according to the configured schedule.

**Before You Start**

Add at least one user, and set the user's authentication mode. For details, see *User Management*.

## Steps

1. Tap **Platform Attendance** to enter the T&A Status page.
2. Set the **Attendance Mode** as **Auto**.

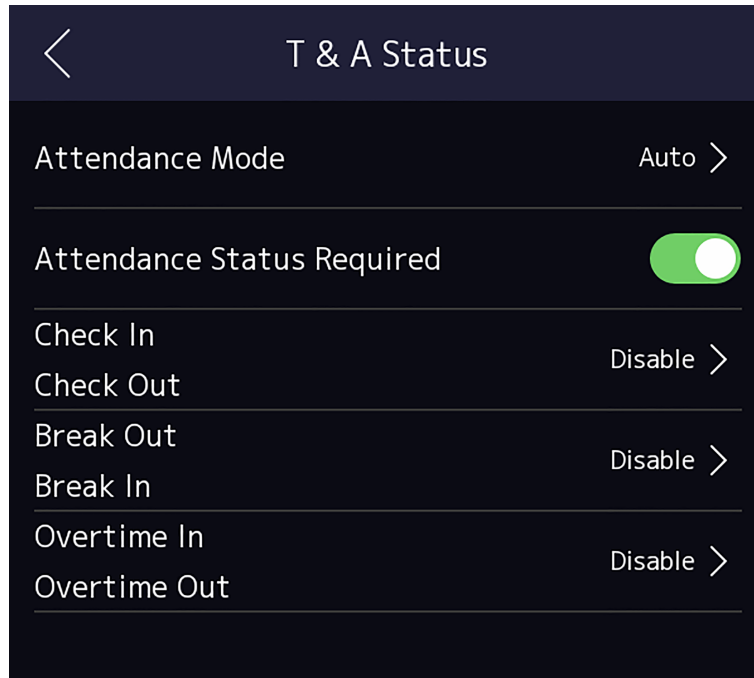

**Figure 7-17 Auto Attendance Mode**

3. Enable the **Attendance Status** function.
4. Enable a group of attendance status.

---

### **Note**

The Attendance Property will not be changed.

5. **Optional:** Select an status and change its name if required.  
The name will be displayed on the T & A Status page and the authentication result page.
6. Set the status' schedule.
  - 1) Tap **Attendance Schedule**.
  - 2) Select **Monday, Tuesday, Wednesday, Thursday, Friday, Saturday, or Sunday**.
  - 3) Set the selected attendance status's start time of the day.
  - 4) Tap **Confirm**.
  - 5) Repeat step 1 to 4 according to your actual needs.

---

### **Note**

The attendance status will be valid within the configured schedule.

## Result

When you authenticate on the initial page, the authentication will be marked as the configured attendance status according to the configured schedule.

## Example

If set the **Break Out** as Monday 11:00, and **Break In** as Monday 12:00, the valid user's authentication from Monday 11:00 to 12:00 will be marked as break.

## 7.9.4 Set Manual and Auto Attendance via Device

Set the attendance mode as **Manual and Auto**, and the system will automatically change the attendance status according to the configured schedule. At the same time you can manually change the attendance status after the authentication.

### Before You Start

Add at least one user, and set the user's authentication mode. For details, see *User Management*.

### Steps

1. Tap **Platform Attendance** to enter the T&A Status page.
2. Set the **Attendance Mode** as **Manual and Auto**.

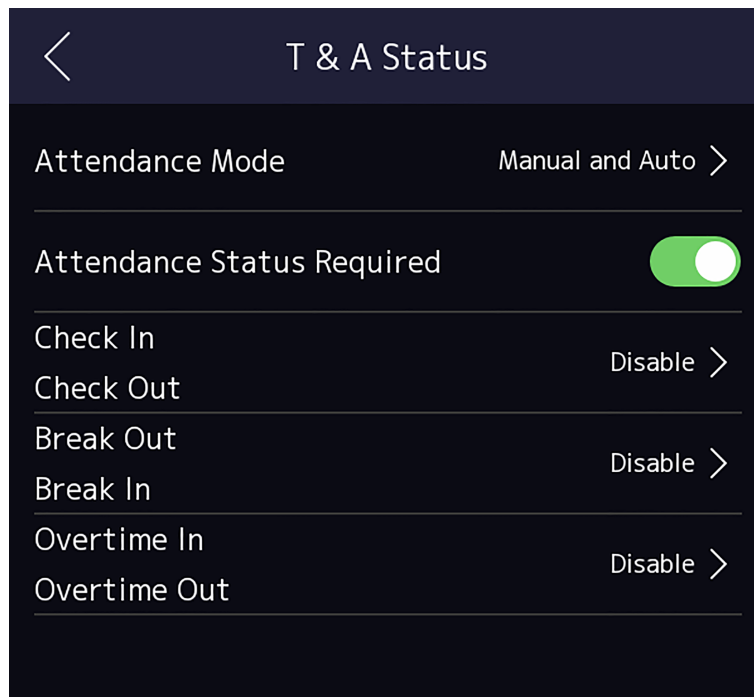

**Figure 7-18 Manual and Auto Mode**

3. Enable the **Attendance Status** function.
4. Enable a group of attendance status.

---

### Note

The Attendance Property will not be changed.

5. **Optional:** Select an status and change its name if required.

The name will be displayed on the T & A Status page and the authentication result page.

6. Set the status' schedule.

- 1) Tap **Attendance Schedule**.
- 2) Select **Monday, Tuesday, Wednesday, Thursday, Friday, Saturday, or Sunday**.
- 3) Set the selected attendance status's start time of the day.
- 4) Tap **OK**.
- 5) Repeat step 1 to 4 according to your actual needs.



### Note

The attendance status will be valid within the configured schedule.

---

### Result

On the initial page and authenticate. The authentication will be marked as the configured attendance status according to the schedule. If you tap the edit icon on the result tab, you can select a status to take attendance manually, the authentication will be marked as the edited attendance status.

### Example

If set the **Break Out** as Monday 11:00, and **Break In** as Monday 12:00, the valid user's authentication from Monday 11:00 to 12:00 will be marked as break.

## 7.10 Preference Settings

You can configure preference settings parameters.

### Steps

1. Tap **System** → **Preference** to enter the preference settings page.

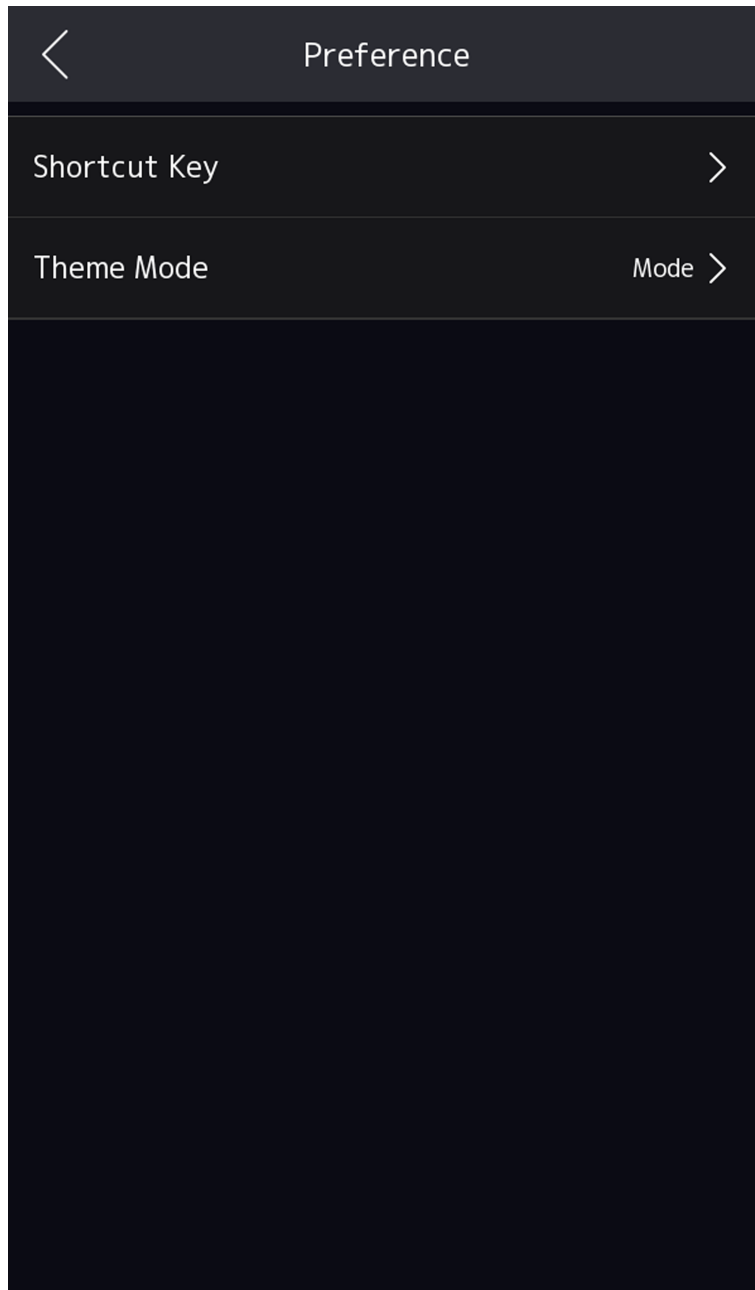

**Figure 7-19 Preference Settings**

### **7.10.1 Set Shortcut Key via Device**

Choose the shortcut key that displayed on the authentication page, including the QR code function, the call function, call type, and the password entering function.

Login the device. For details, see [Login](#) .

Tap **System Settings** → **Preference**.

Choose the shortcut key that displayed on the authentication page, including the QR code function, the call function, call type, and the password entering function.

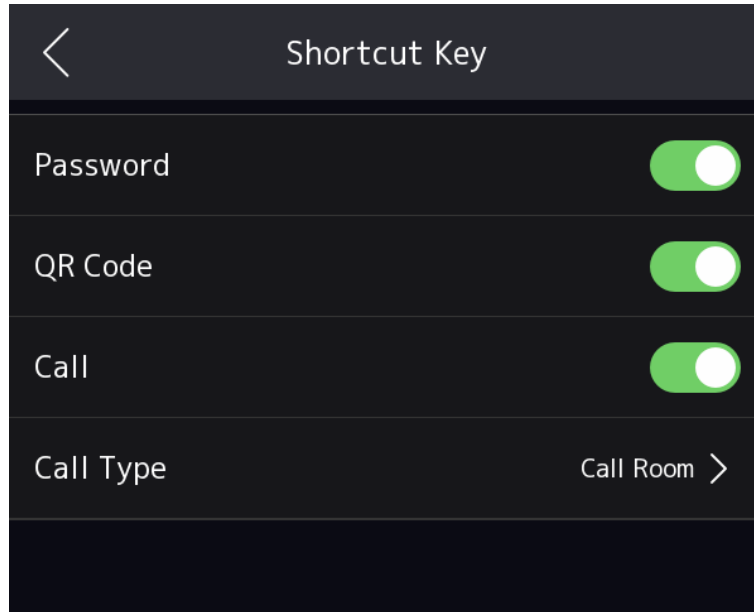

**Figure 7-20 Shortcut Key Settings**

## **Password**

Enable this function and you can enter the password to authenticate via password. Tap  on the authentication page to verify.

## **QR Code**

You can use the QR code scanning function on the authentication interface. The device will upload the information associated with the obtained QR code to the platform. Tap  on the authentication page to verify.

## **Call**

You can select call types from Call Room, Call Center, Call Specified Room, or Call APP. If you select **Call Specified Room**, you should enter the room No.

Tap  on the authentication page to call.

## **7.10.2 Theme**

Select different theme and the authentication page will show different contents.

Login the device. For details, see [Login](#) .

**System Settings** → **Preference**.

Select a theme mode.

## Authentication

The live view will be displayed in authentication, and in the meanwhile, the person's name, employee ID, face pictures will all displayed as well.

## Advertisement

The advertising area and identification authentication area of the device will be displayed on separate screens. Video, text, welcome words will be displayed in the advertizement area.

## 7.11 System Maintenance

Long tap on the initial page for 3 s and slide to the left/right by following the gesture and login the home page. Tap **Maint.**

### 7.11.1 View System Information

View the device system information.

Long tap on the initial page for 3 s and slide to the left/right by following the gesture and login the home page. Tap **Maint.** → **System Info.** .

You can view the device model, serial No., versions, address, production data, QR code, and open source code license.



#### Note

The page may vary according to different device models. Refers to the actual page for details.

---

Long tap  on the right corner to enter the advanced settings page. You can set biometrics parameters and view the device version information.

## Biometric Parameter

### Custom Anti-Spoofing Detection

#### Face Liveness Level

After enabling face anti-spoofing function, you can set the matching security level when performing live face authentication.

#### Anti-Spoofing Detection Threshold

The larger the value, the smaller the false accept rate and the larger the false rejection rate. The smaller the value, the larger the false accept rate and the smaller the false rejection rate.

#### Lock Face for Anti-Spoofing Protection

After enabling this function, the device will lock automatically when anti-spoofing detection failed.

#### Lock Duration

The lock duration after enabling **Lock Face for Anti-Spoofing Protection** when anti-spoofing detection failed.

### Version Information

You can view the device information.

#### 7.11.2 View Device Capacity via Device

You can view the device capacity.

Long tap on the initial page for 3 s and slide to the left/right by following the gesture and login the home page. Tap **Maint.** → **Capacity**.

You can view the number of, user, face picture, card, fingerprint, palm print and event.



#### Note

Only device installed with fingerprint module supports display fingerprint capacity.

---

#### 7.11.3 Upgrade

##### Online Upgrade

You can online upgrade the device.

Long tap on the initial page for 3 s and slide to the left/right by following the gesture and login the home page. Tap **Maint.** → **Device Upgrade**.

If the device is connected to the network and added to Hik-Connect App, you can tap **Device Upgrade** → **Online Upgrade** on device for upgrading when there is an updated version in Hik-Connect App.

##### Local Upgrade

You can upgrade the device locally.

Long tap on the initial page for 3 s and slide to the left/right by following the gesture and login the home page. Tap **Maint.** → **Device Upgrade**.

Insert an USB flash drive. Tap **Device Upgrade** → **Update vi USB**, and the device will read the digicap.dav file in the USB flash drive to start upgrading.



### 7.11.4 Restore Settings

#### Restore to Factory Settings via Device

All parameters will be restored to the factory settings.

Long tap on the initial page for 3 s and slide to the left/right by following the gesture and login the home page. Tap **Maint.** → **Restore to Factory Settings**. The system will reboot to take effect.

#### Restore to Default Settings via Device

All parameters, except for the communication settings, remotely imported user information, will be restored to the default settings.

Long tap on the initial page for 3 s and slide to the left/right by following the gesture and login the home page. Tap **Maint.** → **Restore to Default Settings**. The system will reboot to take effect.

All parameters, except for the communication settings, remotely imported user information, will be restored System default settings. System will reboot after restoring the default settings.

#### Device Reboot

You can reboot the device manually.

Long tap on the initial page for 3 s and slide to the left/right by following the gesture and login the home page. Tap **Maint.** → **Reboot**.

## 7.12 Video Intercom

After adding the device to the client software, you can call the device from the client software, call the main station from the device, call the client software from the device, call the indoor station from the device, or call the specific room from the device.

### 7.12.1 Call Client Software from Device

#### Steps



1. Get the client software from the supplied disk or the official website, and install the software according to the prompts.
2. Run the client software and the control panel of the software pops up.
3. Click **Device Management** to enter the Device Management interface.
4. Add the device to the client software.

---

## Note

For details about adding device, see *Add Device*.

---

5. Call the client software.
    - 1) Tap  on the device initial page.
    - 2) Enter **0** in the pop-up window.
    - 3) Tap  to call the client software.
  6. Tap **Answer** on the pop-up page of the client software and you can start two-way audio between the device and the client software.
- 

## Note

If the device is added to multiple client softwares and when the device is calling the client software, only the first client software added the device will pop up the call receiving window.

---

## 7.12.2 Call Center from Device

### Steps

1. Get the client software from the supplied disk or the official website, and install the software according to the prompts.
  2. Run the client software and the control panel of the software pops up.
  3. Click **Device Management** to enter the Device Management interface.
  4. Add the main station and the device to the client software.
- 

## Note

For details about adding device, see *Add Device*.



---

5. Set the main station's IP address and SIP address in the remote configuration page.
- 

## Note

For details about the operation, see the user manual of the main station.

---

6. Call the center.
    - If you have configured to call center in the **Basic Settings** , you can tap  to call the center.
    - If you have not configured to call center in the **Basic Settings** , you should tap  →  to call the center
  7. Answers the call via the main station and starts two-way audio.
- 

## Note

The device will call the main station in priority.

---

## 7.12.3 Call Device from Client Software

### Steps

1. Get the client software from the supplied disk or the official website, and install the software according to the prompts.
2. Run the client software and the control panel of the software pops up.
3. Click **Device Management** to enter the Device Management page.
4. Add the device to the client software.



For details about adding device, see *Add Device*.

5. Enter the **Live View** page and double-click the added device to start live view.



For details about operations in the **Live View** page, see *Live View* in the user manual of the client software.

6. Right click the live view image to open the right-click menu.
7. Click **Start Two-Way Audio** to start two-way audio between the device and the client software.



## 7.12.4 Call Room from Device

### Steps

1. Get the client software from the supplied disk or the official website, and install the software according to the prompts.
2. Run the client software and the control panel of the software pops up.
3. Click **Device Management** to enter the Device Management interface.
4. Add the indoor station and the device to the client software.



For details about adding device, see *Add Device*.

5. Link a user to an indoor station and set a room No. for the indoor station.
6. Call the room.
  - If you have configured a specified room No. in the **Basic Settings** , you can tap  to call the room.
  - If you have not configured a specified room No. in the **Basic Settings** , you should tap  on the authentication page of the device. Enter the room No. on the dial page and tap  to call the room.
7. After the indoor station answers the call, you can start two-way audio with the indoor station.

## 7.12.5 Call Mobile Client from Device

### Steps



1. Get the mobile mobile client from the supplied disk or the official website, and install the software according to the prompts.
2. Run the mobile client and add the device to the mobile client.



### Note

For details, see the user manual of the mobile client.

---

3. Enter **Basic Settings** → **Shortcut Key** and enable **Call APP**.
4. Go back to the initial page and call the mobile client.
  - 1) Tap  on the device initial page.
  - 2) Tap  to call the mobile client.

## Chapter 8 Operation via Web Browser

### 8.1 Login

You can login via the web browser or the remote configuration of the client software.



Make sure the device is activated. For detailed information about activation, see [Activation](#) .

---

#### Login via Web Browser

Enter the device IP address in the address bar of the web browser and press **Enter** to enter the login page.

Enter the device user name and the password. Click **Login**.

#### Login via Remote Configuration of Client Software

Download and open the client software. After adding the device, click  to enter the Configuration page.

### 8.2 Forget Password

If you forget the password when logging in, you can change the password by email address or security questions.

On the login page, click **Forget Password**.

Select **Verification Mode**.

#### Security Question Verification

Answer the security questions.

#### E-mail Verification

1. Export the QR code and send it to [pw\\_recovery@hikvision.com](mailto:pw_recovery@hikvision.com) as attachment.
2. You will receive a verification code within 5 minutes in your reserved email.
3. Enter the verification code into the verification code field to verify your identification.

Click **Next**, create a new password and confirm it.

### 8.3 Download Web Plug-In

Both non-Plug-in live view and live view after downing plug-in are available. For better live view, downloading plug-in for live view is recommended.

Click  → **Download Web Pug-In** to download the pulg-in to the local.

## 8.4 Help

### 8.4.1 Open Source Software Licenses

You can view open source software licenses.

Click  → **Open Source Software Statement** on the upper-right corner to view the licenses.

### 8.4.2 View Online Help Document

You can view the help document for Web configuration.

Click  → **Online Document** on the upper right of the Web page to view the document.

## 8.5 Logout

Log out the account.

Click **admin** → **Logout** → **OK** to logout.

## 8.6 Quick Operation via Web Browser

### 8.6.1 Change Password

You can change the device password.

Click  on the top right of the web page to enter the **Change Password** page. You can set security questions from the drop-down list and fill in the answers.

Security Question

Question1  ▾

Answer

Question2  ▾

Answer

Question3  ▾

Answer

Email Address

ⓘ Set an e-mail address to receive verification code for password recovery. ×

E-mail Address

**Figure 8-1 Change Password**

Click **Next** to complete the settings. Or click **Skip** to skip the step.

## 8.6.2 Select Language

You can select a language for the device system.

Click  in the top right of the web page to enter the **Device Language Settings** page. You can select a language for the device system from the drop-down list.

By default, the system language is English.

---

### Note

After you change the system language, the device will reboot automatically.

---

## 8.6.3 Time Settings

Click  in the top right of the web page to enter the wizard page. After setting device language, you can click **Next** to enter the **Time Settings** page.

### **Time Zone**

Select the device located time zone from the drop-down list.

### **Time Sync.**

## NTP

You should set the NTP server's IP address, port No., and interval.

### Manual

By default, the device time should be synchronized manually. You can set the device time manually or check **Sync. with Computer Time** to synchronize the device time with the computer's time.

### Server Address/NTP Port/Interval

You can set the server address, NTP port, and interval.

## DST

You can view the DST start time, end time and bias time.

Click **Next** to save the settings and go to the next parameter. Or click **Skip** to skip time settings.

## 8.6.4 Environment Settings

After activating the device, you should select an application mode for better device application.

### Steps

1. Click  in the top right of the web page to enter the wizard page. After setting device language and time, you can click **Next** to enter the **Environment Settings** page.
2. Select **Indoor** or **Other**.

---

### Note

- If you install the device indoors near the window or the face recognition function is not working well, select **Others**.
- If you do not configure the application mode and tap **Next**, the system will select **Indoor** by default.
- If you activate the device via other tools remotely, the system will select **Indoor** as the application mode by default.

---

Click **Next** to save the settings and go to the next parameter. Or click **Skip** to skip environment settings.

## 8.6.5 Privacy Settings

Set the picture uploading and storage parameters.

Click  in the top right of the web page to enter the wizard page.



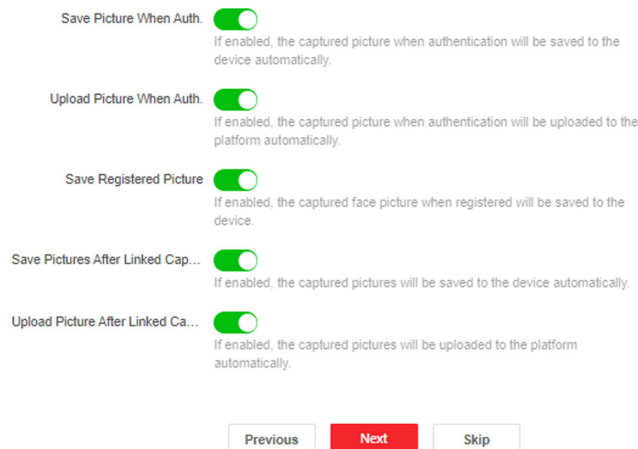

**Figure 8-2 Privacy Settings**

## Picture Uploading and Storage

### Save Picture When Authenticating

Save picture when authenticating automatically.

### Upload Picture When Authenticating

Upload the pictures when authenticating to the platform automatically.

### Save Registered Picture

The registered face picture will be saved to the system if you enable the function.

### Upload Picture After Linked Capture

Upload the pictures captured by linked camera to the platform automatically.

### Save Pictures After Linked Capture

If you enable this function, you can save the picture captured by linked camera to the device.

Click **Next** to save the settings and go to the next parameter. Or click **Skip** to skip privacy settings.

## 8.6.6 Administrator Settings

### Steps

1. Click  in the top right of the web page to enter the wizard page.
2. Enter the employee ID and name of the administrator.
3. Select a credential to add.

---

### Note

You should select at least one credential.

---

- 1) Click **Add Face** to upload a face picture from local storage.



The uploaded picture should be within 200 K, in JPG、JPEG、PNG format.

- 2) Click **Add Card** to enter the Card No. and select the property of the card.



Up to 5 cards can be supported.

- 3) Click **Add Fingerprint** to add fingerprints.



Up to 10 fingerprints are allowed.

---

Click **Complete** to complete the settings.

### 8.6.7 No. and System Network

#### Steps

1. Click  in the top right of the web page to enter the wizard page. After previous settings, you can click **Next** to enter the **No. and Network System Network** settings page.
2. Set the device type.



- If set the device type as **Door Station**, you can set the **Floor No.**, **Door Station No.**, **Community No.**, **Building No.**, **Unit No.**, **Floor No.**, and **Door Station No.**.
- If set the device type as **Outer Door Station**, you can set **Outer Door Station No.**, and **Community No.**

---

#### Device Type

The device can be used as a door station or outer door station. Select a device type from the drop-down list.

#### Community No.

Set the device community No.

#### Building No.

Set the device building No.

#### Unit No.

Set the device unit No.

#### Floor No.

Set the device installed floor No.

#### Door Station No.

Set the device installed door station No.



The main door station No. is 0, and the sub door station No. ranges from 1 to 16.

---

### Outer Door Station No.

Set the device installed outer door station No.

---



The No. ranges from 1 to 99.

---

### 3. Set the video intercom network parameters.

#### Registration Password

Set the registration password of the main station for communication. Set the registration password of the main station for communication.

#### Main Station IP

Enter the main station's IP address that used for communication.

#### Private Server IP

Refers to the SIP server IP. Enter the main station's IP address that used for communication. At this time the main station is used as a SIP server. Other intercom devices should registered to this server address to realize communication.

#### Enable Protocol 1.0

If enabled, the door station can be registered to the main station by old protocol version. If disabled, the door station can be registered to the main station by new protocol version.

### 4. Click **Complete** to save the settings after the configuration.

## 8.7 Person Management

Click **Add** to add the person's information, including the basic information, certificate, authentication and settings.

### Add Basic Information

Click **Person Management** → **Add** to enter the Add Person page.

Add the person's basic information, including the employee ID, the person's name, gender, and person type.

If you select **Visitor** as the person type, you can set the visit times.

If you select **Custom Type**, you can edit the name. The changed name will be applied to the device.

Click **Save** to save the settings.

### Set Permission Time

Click **Person Management** → **Add** to enter the Add Person page.

Enable **Long-Term Effective User**, or set **Long-Term Effective User**, and the person can only has the permission within the configured time period according to your actual needs.

Set the door permission.

Click **Save** to save the settings.

### Set Device No.

Click **Person Management** → **Add Person** → **Add** to enter the Add Person page.

Click the textbox of **Floor No.** and **Room No.** and enter a numeric between 1 and 999 to set the floor No. and room No.

Click **Save** to save the settings.

### Authentication Settings

Click **Person Management** → **Add** to enter the Add Person page.

Set the authentication type.

Click **Save** to save the settings.

### Add Card

Click **Person Management** → **Add** to enter the Add Person page.

Click **Add Card**, enter the **Card No.** and select the **Property**, and click **OK** to add the card.

Click **Save** to save the settings.

### Add Face Picture

Click **Person Management** → **Add** to enter the Add Person page.

Click **+ Upload** to upload a face picture from the local PC.



#### Note

The picture format should be JPG or JPEG or PNG, and the size should be less than 200 kb.

---

Click **Save** to save the settings.

### Add Fingerprint



#### Note

Only devices supporting the fingerprint function can add the fingerprint.

---

Click **Person Management** → **Add** to enter the Add Person page.

Click **Add Fingerprint**, and press your finger on the fingerprint module of the device to add your fingerprint.

Click **Save** to save the settings.

## Add Palm Print

---



- Only devices supporting the palm print function can add the palm print.
  - Up to 10000 palm print and palm vein can be added.
- 

Click **Person Management** → **Add Palm Print** to enter the Add Person page.  
Place the palm at a distance of 5 ~ 12 cm from the peripheral module of the device.  
Click **Save** to save the settings.

## Add Keyfob

Click **Person Management** → **Add** to enter the Add Person page.  
Click **+ Add Keyfob**, and enter Serial No, click **OK**. Press and hold keys in the upper left and lower right corners of keyfob for 10 s to pair with face recognition terminal.

---



Each person can add up to one keyfob, and the device can add up to 5,000 keyfobs. The keyfob serial No. starts with Q-Z followed by 8-digit Arabic numerals.

---

## Device No. Settings

Click **Person Management** → **Add** to enter the Add Person page.  
Add the person's basic information. Go to the Device No. module. Click **Add** and enter the person belonged room No. and floor No. Click **Add** or **Save and Continue**.

## Delete Person

On the person management page, check the person need to delete and click **Delete**.  
Click **Clear All** to clear all person.

## Edit Person

On the person management page, check the person need to edit. Click  to edit the person information.

## Filter

On the person management page, enter **Employee ID / Name / Card No.**. Select **Credential Status**, and click **Filter** to filter the person. Click **Reset** to clear all conditions.

## 8.8 Access Control Management

### 8.8.1 Overview

You can view the live video of the device, linked device, person information, network status, basic information, and device capacity.

Function Descriptions:

#### Door Status

Click  on the video to view the device live video.



Set the volume when starting live view.



#### Note

If you adjust the volume when starting two-way audio, you may hear a repeated sounds.

---



You can capture image when starting live view.



The door status is open/closed/remaining open/remaining closed.



You can record when starting live view.



Select the streaming type when starting live view. You can select from the main stream, sub stream or third stream.



Full screen view.

#### Controlled Status

You can control the door to be opened, closed, remaining open or remaining closed according to your actual needs.

#### Real-Time Event

You can view the event Employee ID, Name, Card No., Event Type, Time, and Operation. You can also click **View More** to enter the page of Event Search. You can select event types, enter the employee ID, the name, the card No., the start time, and the end time, and click **Search**. The results will be displayed on the right panel.

#### Link Device

You can view the quantity and status of linked devices.



You can click **View More** to go to .

---

### Person Information

You can view the added and not added information of person credentials.

### Network Status

You can view the connected and registered status of wired network, wireless network, Hik-Connect, ISUP, OTAP, and VoIP.

### Basic Information

You can view the model, serial No. and firmware version.

### Device Capacity

You can view the person, face, fingerprint, card, palm print and event capacity.

---



Only device installed fingerprint or palm print module can display the fingerprint or palm print capacity.

---

## 8.8.2 Search Event

Click **Event Search** to enter the Search page.

Enter the search conditions, including the event type, the employee ID, the name, the card No., the start time, and the end time, and click **Search**.

The results will be displayed on the right panel.

## 8.8.3 Door Parameter Configuration

Configure parameters for unlocking doors.

### Select Door No.

Select a door to configure relative parameters.

Click **Access Control** → **Parameter Settings** → **Door Parameters** to enter the settings page.

Select **Door No.**. Usually, Door 1 is the door linked with the device and door 2 is the door linked with the secure door control unit.

Set other door parameters and click **Save**.

## View Device Online Status

View and refresh the device status.

Click **Access Control** → **Parameter Settings** → **Door Parameters** to enter the settings page.

You can view the online status of the device. Click **Refresh** to refresh the status of the device.

## Set Door Name

Create door name.

Click **Access Control** → **Parameter Settings** → **Door Parameters** to enter the settings page.

Set **Door Name** and click **Save**.

## Set Open Duration via PC Web

You can set the time for the door lock to open after swiping the card.

Click **Access Control** → **Parameter Settings** → **Door Parameters** to enter the settings page.

Set the open duration, that is the action time after the door is unlocked. If the door is not opened within the set time, the door will automatically lock. Configurable time: 1 to 255 seconds.

Click **Save**.

## Set Door Open Timeout Alarm via PC Web

If the door is not closed after reaching the lock action time, the access control point will sound an alarm.

Click **Access Control** → **Parameter Settings** → **Door Parameters** to enter the settings page.

Set **Door Open Timeout Alarm**. If the door is not closed after reaching the lock action time, the access control point will sound an alarm. When set as 0, alarm will not be enabled.

Click **Save**.

## Set Door Magnetic Sensor Type via PC Web

You can select door contact type according to the wiring method.

Click **Access Control** → **Parameter Settings** → **Door Parameters** to enter the settings page.

Select magnetic sensor type as remain closed or remain open. By default, it is **Remain Closed** (excluding special needs).

Click **Save**.



### Set Exit Button via PC Web

Set the exit button as remain open or remain closed according to the actual wiring method.

Click **Access Control** → **Parameter Settings** → **Door Parameters** to enter the settings page.

Set **Exit Button Type**. By default, it is Remain Open (excluding special needs).

Click **Save**.

### Set Door Lock Powering Off Status via PC Web

You can set the door lock status when the door lock is powering off.

Click **Access Control** → **Parameter Settings** → **Door Parameters** to enter the settings page.

Set **Door Lock Powering Off Status**. By default, it is remain closed.

Click **Save**.

### Set Extended Open Duration via PC Web

The door contact can be enabled with appropriate delay after person with extended access needs swipes her/his card.

Click **Access Control** → **Parameter Settings** → **Door Parameters** to enter the settings page.

Set **Extended Open Duration**. The door contact can be enabled with appropriate delay after person with extended access needs swipes her/his card.

Click **Save**.

### Set Door Remain Open Duration with First Person via PC Web

After the first person is authorized, it allows multiple persons access the door or other authentication actions.

Click **Access Control** → **Parameter Settings** → **Door Parameters** to enter the settings page.

Set the door open duration when first person is in and click **Save**.

### Set Duress Code via PC Web

After configuring duress code, when encountering duress, enter the code to open the door. At the same time, the access control system will report duress events.

Click **Access Control** → **Parameter Settings** → **Door Parameters** to enter the settings page.

Set duress code, and click **Save**.

## Note

Duress code and super password can't be duplicated, usually consisting of 4 to 8 digits.

---

## Set Super Password via PC Web

Administrator or designated person can enter the super password to open the door.

Click **Access Control** → **Parameter Settings** → **Door Parameters** to enter the settings page.

Set **Super Password**, the designated person can enter the super password to open the door.

Click **Save**.

---

## Note

Duress code and super password can't be duplicated, usually consisting of 4 to 8 digits.

---

## 8.8.4 Authentication Settings

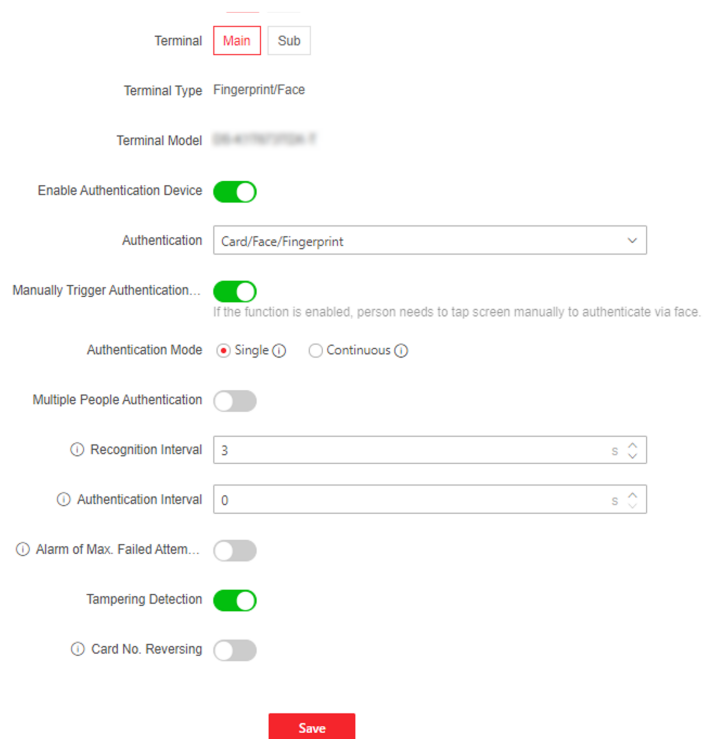

Terminal  Main  Sub

Terminal Type Fingerprint/Face

Terminal Model DS-K1T673

Enable Authentication Device

Authentication

Manually Trigger Authentication...   
If the function is enabled, person needs to tap screen manually to authenticate via face.

Authentication Mode  Single  Continuous

Multiple People Authentication

Recognition Interval  s

Authentication Interval  s

Alarm of Max. Failed Attem...

Tampering Detection

Card No. Reversing

**Figure 8-3 Authentication Settings**

## Select Main or Sub Card Reader via PC Web

Set the terminal for person authentication.

Click **Access Control** → **Parameter Settings** → **Authentication Settings** to enter the settings page.

Select the terminal as main or sub card reader.

Set other parameters and click **Save**.

## View Terminal Type and Model via PC Web

You can view terminal type and model.

Click **Access Control** → **Parameter Settings** → **Authentication Settings** to enter the settings page.

View **Terminal Type** and **Terminal Model**.

## Enable Authentication Device via PC Web

After enabling, the authentication terminal can be used for card swiping.

### Steps

1. Click **Access Control** → **Parameter Settings** → **Authentication Settings** to enter the settings page.
2. Enable **Authentication Device**. After enabling, the terminal can be used for card swiping normally.
3. Click **Save**.

## Set Authentication via PC Web

Configure Certification.

Click **Access Control** → **Parameter Settings** → **Authentication Settings** to enter the settings page.

When selecting main card reader as the Terminal, you can select Authentication from the drop-down list. When there is more than one authentication, you should set **Single Credential Authenticating Timeout** and **Control Initial Authentication Type**.

### Single Credential Authenticating Timeout

You can configure the duration for each certification.



### Note

The password authenticating timeout is 20 s by default, which is not limited by above settings.

---

### Control Initial Authentication Type

If enabled, all selected types can be used for first-time authentication.

When selecting sub card reader as the Terminal, you can select Authentication from the drop-down list.

Click **Save**.

### Manually Trigger Authentication via Face on PC Web

After enabling **Manually Trigger Authentication via Face**, you need to touch the screen of the device manually for face recognition.

Click **Access Control** → **Parameter Settings** → **Authentication Settings** to enter the settings page.

When the main card reader is selected as the Terminal, click to enable **Manually Trigger Authentication via Face** and choose authentication mode.

#### Single Recognition

After completing the previous facial recognition, no matter successful or failed, you need to tap the screen to trigger the next recognition.

#### Continuous

After triggering the recognition, you can recognize via face until the device enter into the sleeping mode.

Click **Save**.

### Enable Multiple People Authentication via PC Web

When enabled, multiple people can simultaneously verify faces for authentication.

Click **Access Control** → **Parameter Settings** → **Authentication Settings** to enter the settings page.

When you select the terminal as main card reader, enable **Multiple People Authentication**, and click **Save**.

### Set Recognition Interval via PC Web

Set the time interval between two continuous face recognitions when authenticating.

Click **Access Control** → **Parameter Settings** → **Authentication Settings** to enter the settings page.

When you select the terminal as main or sub card reader, set recognition interval, and click **Save**.



#### Note

Please enter a number between 1 and 10.

---

### Set Authentication Interval via PC Web

You can set the authentication interval of the same person when authenticating. The same person can only authenticate once in the configured interval. A second authentication will be failed. If other person authenticate in the configured interval, the person can authenticate again.

Click **Access Control** → **Parameter Settings** → **Authentication Settings** to enter the settings page. When you select the terminal as main card reader, set **Authentication Interval**, and click **Save**.

### Enable Alarm of Max. Failed Attempts via PC Web

Enable to report alarm when the card reading attempts reach the set value.

Click **Access Control** → **Parameter Settings** → **Authentication Settings** to enter the settings page.

When you select the terminal as main or sub card reader, slide to enable **Alarm of Max. Failed Attempts**, and set **Max. Authentication Failed Attempts**.

Click **Save**.

### Set Palm Print Recognition Timeout Threshold and Recognition Interval via PC Web

Set palm print recognition timeout threshold and the interval between two continuous palm print recognition when authenticating.

Click **Access Control** → **Parameter Settings** → **Authentication Settings** to enter the settings page.

When you select the terminal as main or sub card reader, set **Palm Print Recognition Timeout Threshold** and **Palm Print Recognition Interval**, and click **Save**.

### Enable/Disable Tampering Detection via PC Web

You can enable tampering detection, the device will automatically generate tampering events when the card reader is removed or taken away.

Click **Access Control** → **Parameter Settings** → **Authentication Settings** to enter the settings page.

Enable or disable **Tampering Detection** according to your actual needs. After enabling the function, the device will automatically generate tampering events when the card reader is removed or taken away. If the function is disabled, no alarm events will be generated.

Click **Save**.

### Enable/Disable Card No. Reversing via PC Web

You can enable or disable the card No. reversing function.

Click **Access Control** → **Parameter Settings** → **Authentication Settings** to enter the settings page.

Enable **Card No. Reversing**, the read card No. will be in reverse sequence.

Click **Save**.

### Set Sub Card Reader Position

You can choose the position for the sub card reader.

Click **Access Control** → **Parameter Settings** → **Authentication Settings** to enter the settings page.

When Sub Card Reader is selected as the Terminal, you can select the position of sub card reader as **Different Side from Main Card Reader** or **Same Side as Main Card Reader**. Click **Save**.

### Set Communication with Controller Every via PC Web

You can set communication with controller every of sub card reader. If the card reader can't connect with the access controller in the set time, the card reader is offline.

Click **Access Control** → **Parameter Settings** → **Authentication Settings** to enter the settings page.

When you select the terminal as sub card reader, set **Communication with Controller Every**, and click **Save**.

### Set Timeout Duration of Entering Password via Web Client

Set the maximum interval of entering two characters of the password. After entering one character, if the next character is not entered within the set interval, the entered characters will all be automatically cleared.

Click **Access Control** → **Parameter Settings** → **Authentication Settings** to enter the settings page.

When selecting the sub card reader as the Terminal, you can set **Max. Interval When Entering Password** and click **Save**.

### Set OK LED Polarity and Error LED Polarity via PC Web

Select the polarity of the diodes for OK and ERR interfaces according to actual wiring, with a default positive polarity.

Click **Access Control** → **Parameter Settings** → **Authentication Settings** to enter the settings page.

When you select the terminal as sub card reader, set **OK LED Polarity** and **Error LED Polarity**, and click **Save**.

## 8.8.5 Set Face Parameters

**Face Recognition Parameters**

- Face Anti-spoofing
- Face Duplicate Check
- Anti-Spoofing Detection Le...  General  Advanced  Professional
- Recognition Distance  Auto  0.5m  1m  1.5m  2m
- Pitch Angle
- Yaw Angle
- Face Picture Quality Grade for ...
- 1:1 Face Picture Grade Th...
- 1:1 Matching Threshold
- 1:N Matching Threshold
- Face Recognition Timeout Value
- Face Recognition Area

**Fingerprint Parameters**

- Fingerprint Security Level

**ECO Mode Parameter**

- ECO Mode
- ECO Mode Threshold
- ECO Mode (1:1) Threshold
- ECO Mode (1:N) Threshold

**Face Mask Detection Parameters**

- Face with Mask Detection
- Face without Mask Strategy  None  Reminder of Wearing Face Mask  Must Wear Face Mask
- Face with Mask&Face (1:1)
- Face with Mask 1:N Match ...
- Face with Mask 1:1 Match ...
- Face with Mask 1:N Match ...

**Hard Hat Detection**

- Enable Hard Hat Detection

Figure 8-4 Set Face Parameters

### Enable/Disable Face Anti-spoofing via Web Browser

When enabled, the device can recognize whether the person is a live one or not.

Click **Access Control** → **Parameter Settings** → **Smart** to enter the settings page.

Enable **Face Anti-spoofing** and click **Save**.

Enable or disable the live face detection function. When enabled, the device can recognize whether the person is a live one or not. If the face is not a live one, authentication will fail.

### Enable/Disable Face Duplicate Check

After enabling face duplicate check and everytime adding person's face, the system will check the face's duplication. If a duplicated face is detected, a prompt will be on.



#### Note

The function is not supported when add face remotely or applying face in batch.

---

Click **Access Control** → **Parameter Settings** → **Smart** to enter the settings page.

Enable **Face Duplicate Check**.

Click **Save**.

### Set Anti-Spoofing Detection Level via PC Web

After enabling the face anti-spoofing function, you can set the matching security level when performing live face authentication.

Click **Access Control** → **Parameter Settings** → **Smart** to enter the settings page.

Select the anti-spoofing detection level and click **Save**.

You can choose from general, advanced and professional. The higher the level, the lower the fake recognition rate and the higher the rejection rate.

### Set Recognition Distance via PC Web

You can set the distance between the authenticating user and the device camera.

Click **Access Control** → **Parameter Settings** → **Smart** to enter the settings page.

Select the recognition distance, and click **Save**.

### Set Pitch Angle via PC Web

You can set the pitch angle of the lens during face recognition and authentication.

Click **Access Control** → **Parameter Settings** → **Smart** to enter the settings page.

---



#### Note

Different models may support different parameters, please refer to the actual page.

---

Set **Pitch Angle** and click **Save**.



## Set Yaw Angle via PC Web

You can set the yaw angle of the lens during face recognition and authentication.

Click **Access Control** → **Parameter Settings** → **Smart** to enter the settings page.



Different models may support different parameters, please refer to the actual page.

---

Set yaw angle, and click **Save**.

## Set Face Picture Quality Grade for Applying via PC Web

The grade for face authentication needs to be higher than the threshold to be successful.

Click **Access Control** → **Parameter Settings** → **Smart** to enter the settings page.



Different models may support different parameters, please refer to the actual page.

---

Set **Face Picture Quality Grade for Applying**, the grade for face authentication needs to be higher than the threshold to be successful.

Click **Save**.

## Set 1:1 Face Grade Threshold via PC Web

Set 1:1 face grade threshold.

Go to **Access Control** → **Parameters Settings** → **Smart**.

Set **1:1 Face Picture Grade Threshold**, and click **Save**.

The higher the threshold, the higher the requirements for the quality of the captured images of the front camera, and the easier to prompt authentication failure.

## Set Face 1:1 Matching Threshold via PC Web

Set face 1:1 matching threshold.

Click **Access Control** → **Parameter Settings** → **Smart** to enter the settings page.

Set face 1:1 matching threshold and click **Save**.

The larger the value of the threshold, the fault acceptance rate will be lower and the false rejection rate will be higher when authenticating via face. The maximum value is 100.

## Set 1:N Matching Threshold via PC Web

You can set the matching threshold for face 1:N matching.

Click **Access Control** → **Parameter Settings** → **Smart** to enter the settings page.

Set the 1:N matching threshold and click **Save**.

The larger the value, the smaller the false accept rate and the larger the false rejection rate. The maximum value is 100.

## Set Face Recognition Area via Web Browser



You can set the recognition area of the lens during face recognition and authentication.

Click **Access Control** → **Parameter Settings** → **Area Configuration** to enter the settings page.

Drag the yellow box in the preview screen to adjust the effective area for face recognition on the left, right, up, and down sides.

Or drag the block or enter the number to set the effective area.

Click **Save**.

Click  ,  , or  to capture, record, or go to full screen view.

## Set Fingerprint Parameters via PC Web

You can set the fingerprint parameters of the device.

Click **Access Control** → **Parameter Settings** → **Smart** to enter the settings page.

Select **Fingerprint Security Level**. The higher the level, the lower the fake recognition rate and the higher the rejection rate.

Click **Save**.

## Set Palm Print Recognition Parameters via PC Web

You can set the palm print parameters of the device.

Click **Access Control** → **Parameter Settings** → **Smart** to enter the settings page.

Enable **Palm Print Anti-Spoofing Detection**. Set **Palm Print 1:1 Threshold** and **Palm Print 1:N Threshold**.



### Note

The larger the value, the smaller the false accept rate and the larger the false rejection rate. The maximum value is 100.

---

Click **Save**.

### Enable/Disable ECO Mode via PC Web

If the ECO mode is enabled, you can authenticate faces in the low light or dark environment with IR camera.

Click **Access Control** → **Parameter Settings** → **Smart** to enter the settings page.

If the ECO mode is enabled, you can authenticate faces in the low light or dark environment with IR camera. You can set the ECO mode (1:N) and ECO mode (1:1).

If the face with mask detection is enabled, you can set face mask detection parameters also.

#### ECO Mode (1:1) Threshold

Set the matching threshold when authenticating via ECO mode 1:1 matching mode. The larger the value, the smaller the false accept rate and the larger the false rejection rate. The maximum value is 100.

#### ECO Mode (1:N) Threshold

Set the matching threshold when authenticating via ECO mode 1:N matching mode. The larger the value, the smaller the false accept rate and the larger the false rejection rate. The maximum value is 100.

#### Face with Mask 1:1 Match Threshold (ECO)

Set the matching threshold when authenticating with face mask via ECO mode 1:1 matching mode. The larger the value, the smaller the false accept rate and the larger the false rejection rate. The maximum value is 100.

#### Face with Mask 1:N Match Threshold (ECO)

Set the matching threshold when authenticating with face mask via ECO mode 1:N matching mode. The larger the value, the smaller the false accept rate and the larger the false rejection rate. The maximum value is 100.

Click **Save**.

### Enable/Disable Face with Mask Detection via PC Web

After enabling the face with mask detection, the system will recognize the captured face with mask picture or not.

Click **Access Control** → **Parameter Settings** → **Smart** to enter the settings page.

After enabling the face with mask detection, you can set **Face without Mask Strategy**, **Face with Mask&Face (1:1)**, **Face with Mask 1:N Match Threshold (ECO)**, **Face with Mask 1:1 Match Threshold** and **Face with Mask 1:N Match Threshold (ECO)**.

#### Face without Mask Strategy

You can select **None**, **Reminder of Wearing Face Mask** and **Must Wear Face Mask**.

#### Reminder of Wearing Face Mask

If the person do not wear the face mask when authenticating, the device will pop up a prompt and the door will open.

### **Must Wear Face Mask**

If the person do not wear the face mask when authenticating, the device will pop up a prompt and the door will keep closed.

### **Face with Mask&Face (1:1)**

Set the matching value when authenticating with face mask via 1:1 matching mode. The larger the value, the smaller the false accept rate and the larger the false rejection rate. The maximum value is 100.

### **Face with Mask&Face (1:N)**

Set the matching threshold when authenticating with face mask via 1:N matching mode. The larger the value, the smaller the false accept rate and the larger the false rejection rate. The maximum value is 100.

### **Face with Mask 1:1 Match Threshold (ECO)**

Set the matching value when authenticating with face mask via ECO mode 1:1 matching mode. The larger the threshold, the lower the recognition error rate and the higher the rejection rate when authenticating faces. The maximum value is 100.

### **Face with Mask 1:N Match Threshold (ECO)**

Set the matching value when authenticating with face mask via ECO mode 1:N matching mode. The larger the threshold, the lower the recognition error rate and the higher the rejection rate when authenticating faces. The maximum value is 100.

Click **Save**.

## **Enable/Disable Hard Hat Detection via PC Web**

After enabling the hard hat detection, the system will recognize whether the safety helmet is worn when authenticating faces.

Click **Access Control** → **Parameter Settings** → **Smart** to enter the settings page.

Enable **Hard Hat Detection** and click **Save**.

### **Enable Hard Hat Detection**

You can set the reminder strategy.

#### **Reminder of Wearing**

If the person do not wear the hard hat when authenticating, the device will pop up a prompt and the door will open.

#### **Must Wear**

If the person do not wear the hard hat when authenticating, the device will pop up a prompt and the door will keep closed.

## 8.8.6 Card Settings

### Enable/Disable NFC Protection via PC Web

After enabling, the device can read NFC card.

Click **Access Control** → **Parameter Settings** → **Card Settings** to enter the settings page.

Click to **Enable NFC Card** and click **Save**. After enabling, the device can read NFC card. If the data of access control devices is obtained by mobile devices, the situation of unauthenticated access may occur. To prevent this situation, you can disable NFC function.

### Enable/Disable M1 Card via Web Client

After enabling, the device can recognize M1 card and users can swipe M1 card via the device.

Click **Access Control** → **Parameter Settings** → **Card Settings** to enter the settings page.

Click to **Enable M1 Card**.

#### M1 Card Encryption

Enable M1 Card Encryption can improve the security level of the entrance card. Therefore, the entrance card will be harder to be copied.

#### Sector

After enabling M1 Card Encryption, you will need to set the encrypted sector.



#### Note

You are advised to encrypt sector 13.

---

Click **Save**.

### Enable/Disable EM Card via Web Client

After enabling, the device can recognize EM card and users can swipe EM card via the device.

Click **Access Control** → **Parameter Settings** → **Card Settings** to enter the settings page.

Click to **Enable EM Card** and click **Save**.



#### Note

- If the peripheral card reader which can read EM card is connected, after enabling this function, you can also swipe EM card via this card reader.
  - When a Dual-frequency Card Module is connected, you can swipe both the EM card and the DESfire card at the same time. However, swiping the card on the device is invalid.
-

## Enable/Disable CPU Card via Web Client

After enabling, the device can recognize CPU card and users can swipe CPU card via the device.

Click **Access Control** → **Parameter Settings** → **Card Settings** to enter the settings page.

Click to **Enable CPU Card**.

Click to **Enable CPU Card Read Content**. After enabling, the device can read content from CPU card.

Click **Save**.

## Set DESFire Card

You can enable DESFire card and DESFire card read content.

Click **Parameter Settings** → **Card Settings** to enter the settings page.

Select **Enable DESFire Card** and **DESFire Card Read Content** and click **Save**.



### Note

When a Dual-frequency Card Module is connected, you can swipe both the EM card and the DESfire card at the same time. However, swiping the card on the device is invalid.

---

## Set FeliCa Card

You can enable FeliCa card.

Click **Parameter Settings** → **Card Settings** to enter the settings page.

Select **Enable FeliCa Card**.

## Set Card No. Authentication Parameters via Web

Set the card reading content when authenticate via card on the device.

Go to **Access Control** → **Parameter Settings** → **Card Settings** .

Select a card authentication mode and click **Save**.

### Full Card No.

All card No. will be read.

### 3 bytes

The device will read card via read 3 bytes.

### 4 bytes

The device will read card via 4 bytes.

## 8.8.7 Elevator Control via Web

### Steps

1. Click **Access Control** → **Parameter Settings** → **Elevator Control Parameters** .

Elevator No.

Elevator Control

Main Elevator Controller Model  DS-K2210  Custom

Interface Type  RS-485  Network Interface

Negative Floor Capacity

Installation Location  Out of Elevator Cab  In Elevator Cab

Call Elevator Mode  Call Elevator Only  Call Elevator + Authorize

**Figure 8-5 Elevator Control**

2. Enable **Elevator Control**.
3. Set the elevator parameters.

#### **Main Elevator Controller Model**

Select an elevator No. for configuration.

#### **Interface Type**

Select a communication type from the drop-down list for elevator communication.

If you select **RS-485**, make sure you have connected the device to the elevator controller with RS-485 wire.

If you select **Network Interface**, enter the elevator controller's IP address, port No., user name, and password for communication.

#### **Negative Floor Capacity**

Set the negative floor number.

#### **Installation Location**

Select installation location as **Out of Elevator Cab** or **In Elevator Cab**.

#### **Call Elevator Mode**

Select call elevator mode.

#### **Call Elevator Only**

After the person passes authentication, the device will call elevator to its floor.

#### **Call Elevator + Authorize**

After the person passes authentication, the device will call elevator to its floor and authorize the permission of the floor linked to the person's room. The person can get to the target floor by pressing corresponding floor No.

## Note

- Up to 4 elevator controllers can be connected to 1 device.
- Up to 10 negative floors can be added.
- Make sure the interface types of elevator controllers, which are connected to the same device, are consistent.

## 8.8.8 Linkage Settings

When the configured event is triggered, upload the event information to the central platform according to the configured method.

### Steps

1. Click **Access Control** → **Parameter Settings** → **Linkage Settings** to enter the settings page.

Figure 8-6 Linkage Settings

2. Click + .
3. Set event source. Select the linkage type as **Event Linkage**, **Card Linkage** or **Link Employee ID**.
  - Select **Linkage Type** as **Event Linkage**, you can select event types according to your actual needs.
  - Select **Linkage Type** as **Card Linkage**, enter **Card No.** and select **Card reader**.
  - Select **Linkage Type** as **Link Employee ID**, enter **Employee ID** and select **Card reader**.
4. Set linkage action.
  - 1) Enable **Door Linkage**, check and select door action.
  - 2) Enable **Linked Alarm Output**, check and select alarm output action.
  - 3) Enable **Linked Capture**.
  - 4) Enable **Link Recording**, click **General Linkage Settings** to set pre-record time and recording delay, and enable record audio when recording video. Click **Save**.



---

### Note

To use the recording function, you need to prepare the SD card. After recording, you can click **Event Search** to view recordings. For details, see [Search Event](#)

---

5. Click **Save** to enable the settings.

### 8.8.9 Set Working Mode via PC Web

You can set the terminal parameters of the device.

---

### Note

Only some models support this function, please refer to the specific device.

---

Click **Access Control** → **Parameter Settings** → **Terminal Parameters** to enter the settings page.

#### Working Mode

You can set the working mode as access control mode or permission free mode.

#### Access Control Mode

The access control mode is the device normal mode. You should authenticate your credential for accessing.

### 8.8.10 Set Remote Verification

The device will upload the person's authentication information to the platform. The platform will judge to open the door or not.

Go to **Access Control** → **Parameter Settings** → **Terminal Parameters**.

Click **Save** after parameters are configured.

#### Remote Verification

After enabling the remote verification, when authenticating, the device will upload authentication information to the platform, and the platform will confirm whether to open the door.

#### Verify Credential Locally

After enabling the function, the device will check permission but not estimate the plan template.

### 8.8.11 Privacy Settings

#### Set Event Storage Type via PC Web Browser

You can configure the event storage type.

Click **Access Control** → **Parameter Settings** → **Privacy Settings** to enter the settings page.

You can select **Event Storage Type** as **Delete Old Events Periodically**, **Delete Old Events by Specified Time** or **Overwriting**.

### **Delete Old Events Periodically**

Drag the block or enter number to set the period for event deleting. All events will be deleted according to the configured time duration.

### **Delete Old Events by Specified Time**

Set a time and all events will be deleted on the configured time.

### **Overwriting**

The earliest 5% events will be deleted when the system detects the stored events has been over 95% of the full space.

Click **Save**.

## **Set Authentication Result via PC Web**

Set authentication result contents, such as picture, name, employee ID, and temperature.

Click **Access Control** → **Access Control** → **Parameter Settings** → **Privacy Settings** .

Check the displayed contents in the authentication result, such as picture, name, employee ID.

Check **Name De-identification** and **ID De-identification** according to actual needs. After de-identification, the name and the ID will display parts of contents.

Set **Authentication Result Display Duration** and the authentication result will display the configured time duration.

Click **Save**.

## **Configure Picture Uploading and Storage via PC Web**

You can set picture uploading and storage parameters.

Click **Access Control** → **Parameter Settings** → **Privacy Settings** to enter the settings page.

### **Save Picture When Auth.**

Save picture when authenticating automatically.

### **Upload Picture When Auth.**

Upload the pictures when authenticating to the platform automatically.

### **Picture Mode**

When selecting as default, the device will capture the panoramic view. You can set the Max. picture size and picture resolution.

When selecting as matting picture mode, the device will only capture face. You can set the Max. picture size.

### **Save Registered Picture**

The registered face picture will be saved to the system if you enable the function.

### **Save Pictures After Linked Capture**

If you enable this function, you can save the picture captured by linked camera to the device.

### **Upload Picture After Linked Capture**

Upload the pictures captured by linked camera to the platform automatically

### **Store Palm Print Registered Picture**

If you disable this, only palm print data will be stored, and registered picture will not be stored.

Click **Save**.

### **Clear Device Pictures via PC Web**

You can clear all registered, authenticated or captured face or pictures.

Click **Access Control** → **Parameter Settings** → **Privacy Settings** to enter the settings page.

Click **Clear** to clear all registered, authenticated, captured face pictures or palm print pictures.

### **Set PIN Mode via PC Web**

Make sure the PIN is platform-applied personal PIN or device-set personal PIN before settings. If the PIN is device-set personal PIN, you can edit the PIN on the device or PC Web, but not set it on the platform. If the PIN is platform-applied personal PIN, you should set the PIN on the platform, but not on the device or PC Web.

Go to **Access Control** → **Parameter Settings** → **Privacy Settings**.

In the PIN Mode module, you can set the following parameters. Click **Save** after parameters settings.

#### **Platform-Applied Personal PIN**

You can create the person PIN on the platform. You should apply the PIN to the device. You cannot create or edit the PIN on the device or PC Web.

#### **Device-Set Personal PIN**

You can create or edit the PIN on the device or PC Web. You cannot set the PIN on the platform.

Click **Save**.

## 8.8.12 Call Settings

### Set Device No. via Web

The device can be used as a door station or outer door station. You should set the device No. before usage.

Click **Access Control** → **Call Settings** → **Device No.** .

Device Type	<input type="text" value="Door Station"/>
Period No.	<input type="text" value="1"/>
Building No.	<input type="text" value="1"/>
Unit No.	<input type="text" value="1"/>
Floor No.	<input type="text" value="1"/>
Door Station No.	<input type="text" value="0"/>
Community No.	<input type="text" value="0"/>

**Save**

**Figure 8-7 Device No. Settings**

If set the device type as **Door Station**, you can set the **Floor No.**, **Door Station No.**, **Community No.**, **Building No.**, and **Unit No.**

#### Device Type

The device can be used as a door station or outer door station. Select a device type from the drop-down list.

---

#### **Note**

If you change the device type, you should reboot the device.

---

#### Floor No.

Set the device installed floor No.

#### Door Station No.

Set the device installed floor No.

---

 **Note**

- If you change the No., you should reboot the device.
  - The main door station No. is 0, and the sub door station No. ranges from 1 to 16.
- 

### **Community No.**

Set the device community No.

### **Building No.**

Set the device building No.

### **Unit No.**

Set the device unit No.

---

 **Note**

If you change the No., you should reboot the device.

---

Click **Save** to save the settings after the configuration.

If set the device type as **Outer Door Station**, you can set outer door station No., and community No.

### **Outer Door Station No.**

If you select outer door station as the device type, you should enter a number between **1** and **99**.

---

 **Note**

If you change the No., you should reboot the device.

---

### **Community No.**

Set the device community No.

## **Configure Video Intercom Network Parameters via Web Browser**

You can set the registration password, main station IP and private server IP, and you can enable protocol 1.0 according to your actual needs.

Click **Call Settings** → **Video Intercom Network** to enter the settings page.

### **Registration Password**

Set the registration password of the main station for communication. Set the registration password of the main station for communication.

### **Main Station IP**

Enter the main station's IP address that used for communication.

### **Private Server IP**

Refers to the SIP server IP. Enter the main station's IP address that used for communication. At this time the main station is used as a SIP server. Other intercom devices should registered to this server address to realize communication.

### Enable Protocol 1.0

If enabled, the door station can be registered to the main station by old protocol version. If disabled, the door station can be registered to the main station by new protocol version.

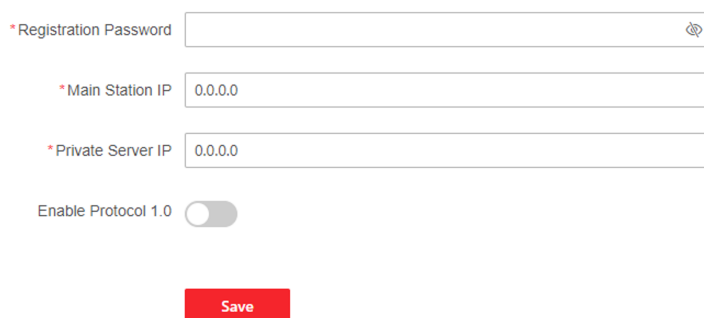

\*Registration Password

\*Main Station IP

\*Private Server IP

Enable Protocol 1.0

Save

**Figure 8-8 Video Intercom Network**

After configuration, you can achieve communication between access control devices and video intercom door station, indoor station, main station, platforms, etc.

Click **Save**.

### Set Communication Time via PC Web

Set the max. communication time.

Go to **Access Control** → **Call Settings** → **Call Settings** .

Enter the **Max. Communication Time**. Click **Save**.

---

#### **Note**

The Max. Communication time range is 90 s to 120 s.

---

### Press Button to Call via PC Web

#### Steps

1. Click **Access Control** → **Call Settings** → **Press Button to Call** to enter the settings page.

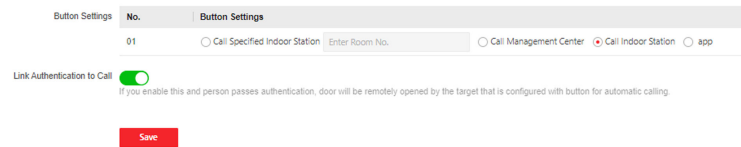

**Figure 8-9 Press Button to Call**

2. Select **Call Specified Indoor Station**, **Call Management Center**, **Call Indoor Station** or **APP** at your needs.

### Note

If you select **Call Specified Indoor Station**, you need to enter the **Room No.** of the indoor station.

3. Enable **Link Authentication to Call** according to your needs. After enabled, when person passes authentication, the door will be remotely opened by the target that is configured with button for automatic calling.
4. Click **Save**.

## Number Settings via PC Web

Set SIP number for the room. The rooms can communicate with each other via SIP number.

### Steps

1. Go to **Access Control** → **Call Settings** → **Number Settings**.

+ Add - Delete

No.	Room No.	SIP Number	Operation
1	4	SIP1 : 114	
2	5	SIP1 : 115	
3	2	SIP1 : 116 SIP2 : 114	
4	6	SIP1 : 116	
5	1	SIP1 : 2002	

**Figure 8-10 Number Settings**

2. Click **Add**, and enter **Room No.** and **SIP1** phone number.
3. **Optional:** Click **Add** to add the SIP number or click  to delete the number.
4. Click **Save**.
5. **Optional:** You can click **Delete** to delete room number and its SIP number.

## 8.9 System Configuration

### 8.9.1 View Device Information via PC Web

View the device name, device No., language, model, serial No., version, number of channels, IO input, IO output, lock, local RS-485 number, register number, alarm input, alarm output, and device capacity, etc.

Click **System and Maintenance** → **System Configuration** → **System** → **System Settings** → **Basic Information** to enter the configuration page.

You can view device name, device No., language, model, serial No., version, number of channels, IO input, IO output, lock, local RS-485 number, register number, alarm input, alarm output, and device capacity, etc.

Click **Upgrade** in the Firmware Version, you can go to the upgrade page to upgrade the device.

### 8.9.2 Set Time

Set the device's time zone, synchronization mode, server address, NTP port, and interval.

Click **System and Maintenance** → **System Configuration** → **System** → **System Settings** → **Time Settings** .

The screenshot shows the 'Time Settings' configuration page. At the top, it displays 'Device Time: 2024-01-02 11:20:48'. Below this, there is a 'Time Zone' dropdown menu currently set to '(GMT+08:00) Beijing, Urumqi, Singapore, Perth'. The 'Time Synchronization mode' is set to 'NTP' (indicated by a selected radio button) with 'Manual' as an alternative. There are three input fields: '\* Server IP Address' with the value '192.0.0.64', '\* NTP Port' with the value '123', and '\* Interval' with the value '60' and a 'min' unit selector. A horizontal line separates the NTP settings from the DST settings. The 'DST' section has a toggle switch that is turned on. Below the toggle, there are two rows of dropdown menus for 'Start Time' and 'End Time'. The 'Start Time' row is set to 'April', 'First', 'Sunday', and '02:00'. The 'End Time' row is set to 'October', 'Last', 'Sunday', and '02:00'. At the bottom of the DST section, there are four radio buttons for 'DST Bias': '30minute(s)', '60minute(s)' (which is selected), '90minute(s)', and '120minute(s)'. A red 'Save' button is located at the bottom center of the form.

Figure 8-11 Time Settings



Click **Save** to save the settings after the configuration.

### Time Zone

Select the device located time zone from the drop-down list.

### Time Sync.

#### NTP

You should set the NTP server's IP address, port No., and interval.

#### Manual

By default, the device time should be synchronized manually. You can set the device time manually or check **Sync. with Computer Time** to synchronize the device time with the computer's time.

#### Server Address Type/Server Address/NTP Port/Interval

You can set the server address type, server address, NTP port, and interval.

### 8.9.3 Change Administrator's Password

#### Steps

1. Click **System and Maintenance** → **System Configuration** → **System** → **User Management** → **User Management** .
2. Click  .
3. Enter the old password and create a new password.
4. Confirm the new password.
5. Click **Save**.



#### Caution

The password strength of the device can be automatically checked. We highly recommend you change the password of your own choosing (using a minimum of 8 characters, including at least three kinds of following categories: upper case letters, lower case letters, numbers, and special characters) in order to increase the security of your product. And we recommend you change your password regularly, especially in the high security system, changing the password monthly or weekly can better protect your product.

Proper configuration of all passwords and other security settings is the responsibility of the installer and/or end-user.

---

### 8.9.4 Account Security Settings via PC Web

You can change the security questions and answers, or the email address for the device. After change the settings, once you forgot the device password, you should answer the new questions or use the new email address to reset the device password.

### Steps

1. Click **System and Maintenance** → **System Configuration** → **System** → **User Management** → **User Management** → **Account Security Settings** .
2. Change the security questions or email address according your actual needs.
3. Enter the device password and click **OK** to confirm changing.

### 8.9.5 View Device Arming/Disarming Information via PC Web

View device arming type and arming IP address.

Go to **System and Maintenance** → **System Configuration** → **System** → **User Management** → **Arming/Disarming Information** .

You can view the device arming/disarming information. Click **Refresh** to refresh the page.

### 8.9.6 Network Settings

#### Set Basic Network Parameters via PC Web

Click **System and Maintenance** → **System Configuration** → **Network** → **Network Settings** → **TCP/IP** .

The screenshot displays the TCP/IP Settings page with the following configuration details:

- NIC Type:** Self-Adaptive (dropdown menu)
- DHCP:** Disabled (toggle switch)
- \*IPv4 Address:** 10.6.122.245
- \*IPv4 Subnet Mask:** 255.255.255.0
- \*IPv4 Default Gateway:** 10.6.122.254
- IPv6 Mode:** Manual (radio button), **DHCP** (radio button, selected), Route Advertisement (radio button)
- IPv6 Address:** 6012:bbbbce2ca:3cff:fe19e0f2
- IPv6 Subnet Prefix Length:** 64
- IPv6 Default Gateway:** fe80::8261:6cff:eda:7445
- Mac Address:** e0:ca:3c:f9:e0:f2
- MTU:** 1500
- DNS Server:** DHCP (toggle switch, enabled)
- Preferred DNS Server:** 8.8.8.8
- Alternate DNS Server:** 8.8.4.4

A red **Save** button is located at the bottom of the form.

**Figure 8-12 TCP/IP Settings Page**

Set the parameters and click **Save** to save the settings.

## NIC Type

Select a NIC type from the drop-down list. By default, it is **Auto**.

## DHCP

If uncheck the function, you should set the IPv4 address, IPv4 subnet mask, IPv4 default gateway, Mac address, and MTU.

If you check the function, the system will allocate the IPv4 address, IPv4 subnet mask, the IPv4 default gateway automatically.

## DNS Server

Set the preferred DNS server and the Alternate DNS server according to your actual need.

## Set Wi-Fi Parameters

Set the Wi-Fi parameters for device wireless connection.

## Steps

### Note

The function should be supported by the device.

1. Click **System and Maintenance** → **System Configuration** → **Network** → **Network Settings** → **Wi-Fi**.

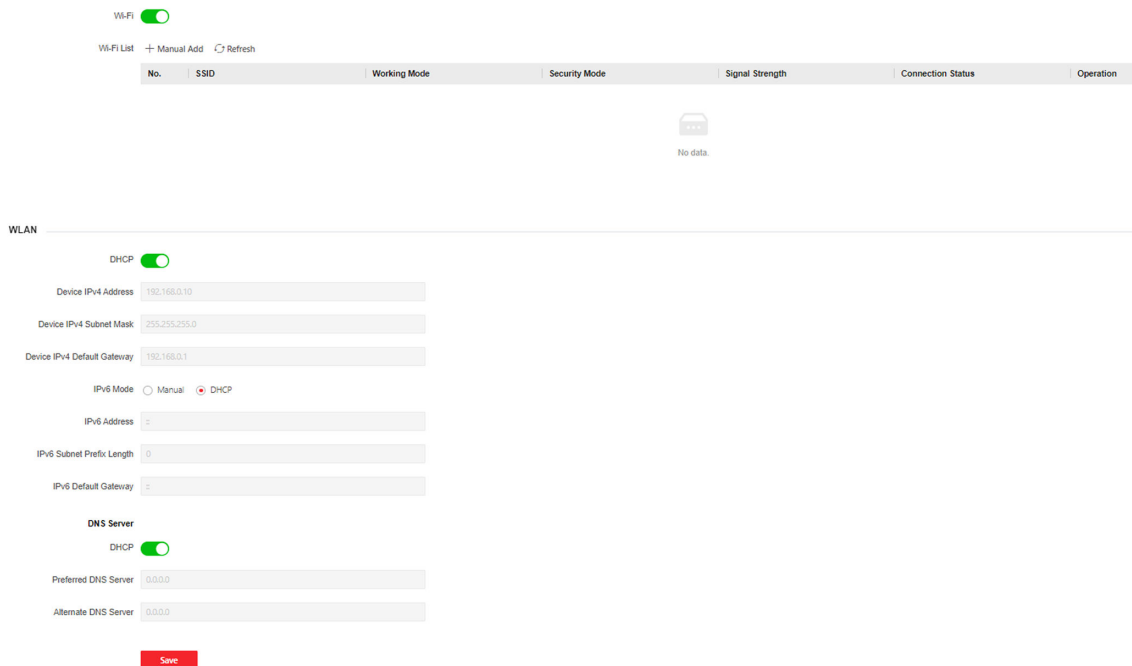



Figure 8-13 Wi-Fi Settings Page

2. Check **Wi-Fi**.
3. Select a Wi-Fi
  - Click  of a Wi-Fi in the list and enter the Wi-Fi password.
  - Click **Add** and enter a Wi-Fi's name, password, and encryption type. Click **Connect**. When the Wi-Fi is connected, click **OK**.
4. **Optional:** Set the WLAN parameters.
  - 1) Set the IP address, subnet mask, and default gateway. Or enable **DHCP** and the system will allocate the IP address, subnet mask, and default gateway automatically.
5. Click **Save**.

## Enable/Disable Bluetooth via PC Web

You can enable device bluetooth to connect a bluetooth sound.

### Steps

1. Click **Access Control** → **System Configuration** → **Network** → **Network Settings** → **Bluetooth** to enter the settings page.
2. In the bluetooth parameter configuration section, enable **Open**.
3. Enter the external sound in the **Device Name**. After the bluetooth is connected, click **Save**.

### Set Port via PC Web

Go to **System and Maintenance** → **System Configuration** → **Network** → **Network Service** .

### Enable/Disable HTTP

Enable the HTTP function to improve the browser's visiting security.

Go to **System and Maintenance** → **System Configuration** → **Network** → **Network Service** → **HTTP(S)** .

Click **Save** after parameters are configured.

#### HTTP Port

When you log in with a browser, you need to add the modified port number after the address. For example, when the HTTP port number is changed to 81, you need to enter http://192.0.0.65 : 81 when you log in with a browser.

#### HTTPS Port

Set the HTTPS port for visiting browser. But certification is required.

#### HTTP Listening

The device will send the alarm information to the destination IP or domain name by HTTP protocol. The destination IP or domain name should support HTTP protocol. Enter the destination IP or domain name, URL and port. And select the protocol type.

### View RTSP Port via PC Web

The RTSP port is the port of real-time streaming protocol.

Go to **System and Maintenance** → **System Configuration** → **Network** → **Network Service** → **RTSP** .  
View the Port.

### Set WebSocket(s) via PC Web

View WebSocket and WebSockets port.

Go to **System and Maintenance** → **System Configuration** → **Network** → **Network Service** → **WebSocket(s)** .

View WebSocket and WebSockets port.

## Enable SDK Service

After enabling SDK service, the device can be connected to the SDK server.

Click **System and Maintenance** → **System Configuration** → **Network** → **Device Access** → **SDK Server** to enter the settings page.

Enter **Server Port**.

Click **Save** to enable the settings.

## Set ISUP Parameters via PC Web

Set the ISUP parameters for accessing device via ISUP protocol.

### Steps



The function should be supported by the device.

---

1. Click **System and Maintenance** → **System Configuration** → **Network** → **Device Access** → **ISUP** .
  2. Check **Enable**.
  3. Set the ISUP version, server address, device ID, and the ISUP status.
- 



If you select 5.0 as the version, you should set the encryption key as well.

---

4. Set the ISUP listening parameters, including ISUP alarm center IP address/domain name, ISUP alarm center URL, and ISUP alarm center port.
5. Click **Save**.

## Set OTAP via PC Web

Connect the device to the platform through the OTAP protocol to obtain device information, upload operation status and alarm information, restart and upgrade the device.

### Steps

1. Click **System and Maintenance** → **System Configuration** → **Network** → **Device Access** → **OTAP** .

Select Central Group

Enable

\* Server IP Address

\* Port

\* Device ID

\* Encryption Key

Register Status ✘ Offline

More ▼

**Figure 8-14 Set OTAP**

2. Click to **Enable** OTAP.
3. Set **Server IP Address**, **Port**, **Device ID** and **Encryption Key**.
4. Click **Test** to ensure the device can connect to the server and register successfully. Refresh the page or restart the device to see the **Register Status**.
5. Click **More** to view the network type and access priority. Drag the operation icon upward or downward to adjust the network priority.
6. Click **Save**.

## Platform Access via PC Web

Platform access provides you an option to manage the devices via platform.

### Steps

1. Click **System and Maintenance** → **System Configuration** → **Network** → **Device Access** → **Hik-Connect** to enter the settings page.

---

### **Note**

Hik-Connect is an application for mobile devices. With the App, you can view live image of the device, receive alarm notification and so on.

2. Check **Enable** to enable the function.
3. **Optional:** Check the checkbox of **Custom**, and you can set the server address by yourself.
4. Enter the verification code.
5. Click **View** to view device QR code. Scan the QR code to bind the account.

## Note

8 to 32 letters (a to z, A to Z) or numbers (0 to 9), case sensitive. You are recommended to use a combination of no less than 8 letters or numbers.

---

6. Click **Save** to enable the settings.

## VoIP Account Settings

You can realize voice call by network.

### Steps

1. Go to **System and Maintenance** → **System Configuration** → **Network** → **Device Access** → **VoIP**.
2. Enable **VoIP Gateway**.
3. Set **Register User Name**、**Registration Password**、**Server IP Address**、**Server Port**、**Expiry Time**、**Register Status**、**Number**、**Display User Name**.

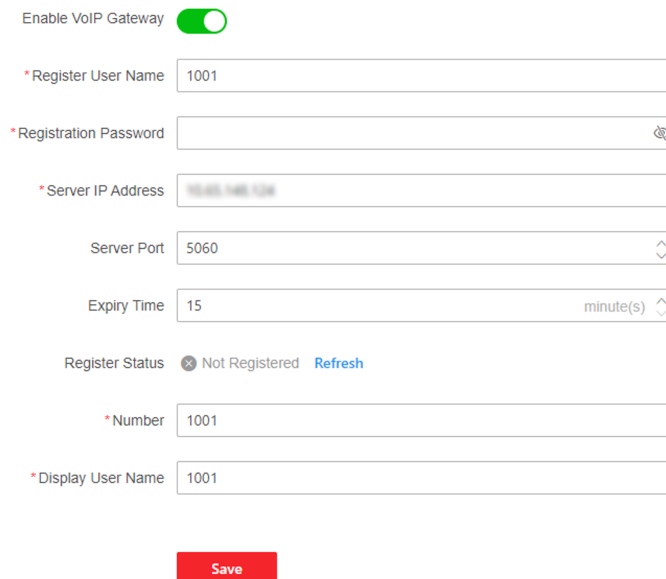

Enable VoIP Gateway

\* Register User Name

\* Registration Password

\* Server IP Address

Server Port

Expiry Time  minute(s)

Register Status  Not Registered [Refresh](#)

\* Number

\* Display User Name

**Save**

**Figure 8-15 VoIP Account Settings**

### Registration Password

Enter the registration password for communication via SIP server. The registration password for the SIP server is configured usually in the main station's SIP settings.

### Server IP Address

Enter the main station's IP address that used for VoIP communication. At this time the main station is used as a SIP server. Other intercom devices should registered to this server address to realize communication.

### Number / Display User Name



The device displayed call number and user name.

4. Click **Save**.

### 8.9.7 Set Video and Audio Parameters via PC Web

#### Configure Video Parameters via Web Browser

You can set quality, resolution and other parameters of device camera.

Click **System and Maintenance** → **System Configuration** → **Video/Audio** → **Video** to enter the settings page.

Set camera name, stream type, video type, resolution, bit rate type, video quality, frame rate, Max. bitrate, video encoding and I frame interval.

Click **Save**.

#### Configure Audio Parameters via Web Browser

You can set device volume.

Click **System and Maintenance** → **System Configuration** → **Video/Audio** → **Audio** to enter the settings page.

Set stream type and audio encoding according to your actual needs. Slide to set input and output volume.

Slide to enable voice prompt function.

You can enable **Audio Mixing**, and set **Output Sub-Volume**.

Click **Save**.

## 8.9.8 Image Parameter Settings

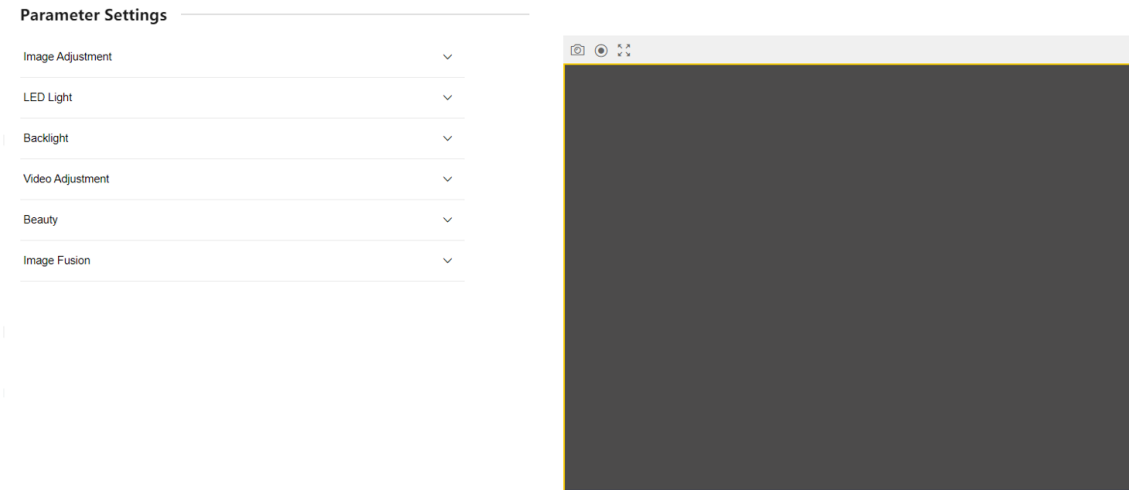

Figure 8-16 Display Settings

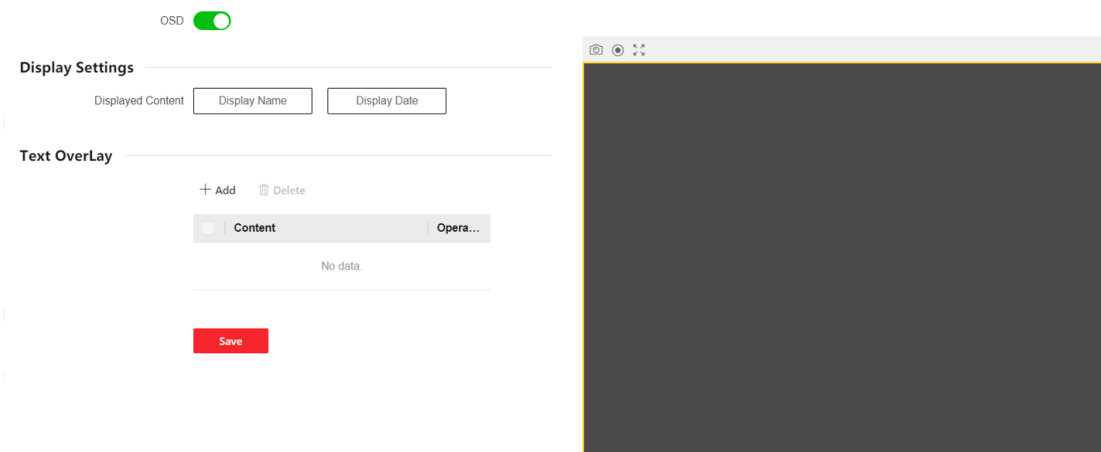

Figure 8-17 OSD Settings

### Set Brightness/Contrast/Saturation/Sharpness via PC Web

You can set picture information such as brightness, contrast, saturation and sharpness of live view page.

Click **System and Maintenance** → **System Configuration** → **Image** → **Display Settings** to enter the settings page.

#### Image Adjustment

Drag the block or enter numbers to set brightness, contrast, saturation and sharpness.

Click **Restore Default Settings** to restore the to the default.

### Set LED Light via PC Web

You can adjust the brightness of the supplement light.

#### Steps

1. Click **System and Maintenance** → **System Configuration** → **Image** → **Display Settings** to enter the settings page.
2. Set the type, mode and brightness of the supplement light.
3. **Optional:** Click **Restore Default Settings** to restore the to the default.

### Set WDR via PC Web

Click **System and Maintenance** → **System Configuration** → **Image** → **Display Settings** to enter the settings page.

Enable or disable wide dynamic range. After enabling, both bright and dark parts of the scene can be seen more clearly at the same time.

Click **Restore Default Settings** to restore the to the default.

### Set Video Standard via PC Web

You can set the video standard of live view page.

Click **System and Maintenance** → **System Configuration** → **Image** → **Display Settings** to enter the settings page.

#### Video Adjustment

Set the video frame rate during remote preview. You need to reboot the device to make the new settings effective.

##### **PAL**

25 frames per second. Suitable for mainland China, Hong Kong (China), the Middle East countries, Europe countries, etc.

##### **NTSC**

30 frames per second. Suitable for the USA, Canada, Japan, Taiwan (China), Korea, the Philippines, etc.

Click **Restore Default Settings** to restore the to the default.

## Set Beauty Parameters via PC Web

After enabling, you can whiten or smooth authenticated pictures.

Click **System and Maintenance** → **System Configuration** → **Image** → **Display Settings** to enter the settings page.

Enable **Beauty**, drag the block or enter numbers to set the whiten and smooth level.

Click **Restore Default Settings** to restore the to the default.

## Set Image Fusion via PC Web

You can enable the image fusion function to improve image quality.

Click **System and Maintenance** → **System Configuration** → **Image** → **Display Settings** to enter the settings page.

### Image Fusion

Set **Image Fusion** as **Auto** or **Disable**. Drag the block or enter numbers to set sensitivity.

Click **Restore Default Settings** to restore the to the default.

## Set OSD Parameters via PC Web

You can customize the camera name, time/date format, display mode, and OSD size displayed on the live view.

### Steps

1. Click **System and Maintenance** → **System Configuration** → **Image** → **OSD Configuration** to enter the settings page.
2. Enable **OSD**.
3. Check the corresponding checkbox to select the display of camera name, date or week if required.
4. Enter **Camera Name**.
5. Select from the drop-down list to set the **Time Format** and **Date Format**.
6. Click **Add** to enter the characters in the textbox, and adjust the OSD position and alignment.

## 8.9.9 Alarm Settings via PC Web

Set the alarm output parameters.

### Steps

1. Click **System and Maintenance** → **System Configuration** → **Event** → **Alarm Settings** → **Alarm Output** .
2. Set **Alarm Name** and mode of **Alarm Duration**.

No. 1

Alarm Name

Alarm Duration  Continuous Alarm  Custom Alarm Duration

Custom 3

Save

**Figure 8-18 Alarm Settings**

### Continuous Alarm

When the alarm is triggered, it will alarm continuously.

### Custom Alarm Duration

You can set **Alarm Duration** for the device when the alarm is triggered.

## 8.9.10 Access Configuration

### Set RS-485 Parameters via PC Web

You can set the RS-485 parameters including the peripheral, address, baud rate, etc.

Click **System and Maintenance** → **System Configuration** → **Access Configuration** → **RS-485** .

Check **Enable RS-485**, and set the parameters.

Click **Save** to save the settings after the configuration.

#### No.

Set the RS-485 No.

#### Peripheral Type

Select a peripheral from the drop-down list according the actual situation. You can select from **Card Reader**, **Extension Module**, **Access Controller**, or **Disable**.



#### Note

After the peripheral is changed and saved, the device will reboot automatically.

---

#### RS-485 Address

Set the RS-485 Address according to your actual needs.

---

## Note

If you select **Access Controller**: If connect the device to a terminal via the RS-485 interface, set the RS-485 address as 2. If you connect the device to a controller, set the RS-485 address according to the door No.

---

## Baud Rate

The baud rate when the devices are communicating via the RS-485 protocol.

## Set Wiegand Parameters via PC Web

You can set the Wiegand transmission direction.

### Steps

---

## Note

Some device models do not support this function. Refer to the actual products when configuration.

---

1. Click **System and Maintenance** → **System Configuration** → **Access Configuration** → **Wiegand Settings** .

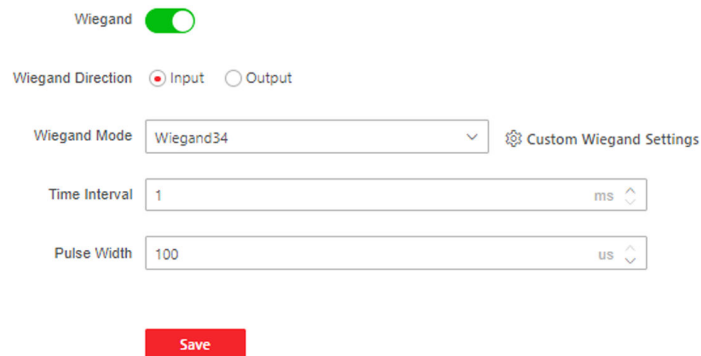

Wiegand

Wiegand Direction  Input  Output

Wiegand Mode Wiegand34 [Custom Wiegand Settings](#)

Time Interval 1 ms

Pulse Width 100 us

Save

**Figure 8-19 Wiegand Page**

2. Check **Wiegand** to enable the Wiegand function.
3. Set a transmission direction.

### Input

The device can connect a Wiegand card reader.

### Output

The can connect an external access controller. And the two devices will transmit the card No. via Wiegand 26 or 34.

4. Click **Save** to save the settings.

---

### Note

If you change the peripheral, and after you save the device parameters, the device will reboot automatically.

---

### Set Secure Door Control Unit Parameters via PC Web

You can set secure door control unit parameters.

#### Steps

1. Click **System and Maintenance** → **Access Configuration** → **Secure Door Control Unit** .
2. Select door.

---

### Note

Selecting door 1 means that the door will be controlled by secure door control unit. The same goes to the selection of door 2.

---

3. View secure door control unit status.
4. You can enable **Two-Door Interlocking**.

---

### Note

If the function is enabled, the two doors cannot be opened at the same time.

---

### 8.9.11 Time and Attendance Settings

If you want to record the person's working hour, late arrivals, early departures, breaks, absenteeism, etc., you can add the person to the shift group and assign a shift schedule (a rule for the attendance defining how the schedule repeats, the shift type, break settings, and the card swiping rule.) to the shift group to define the attendance parameters for the persons in the shift group.

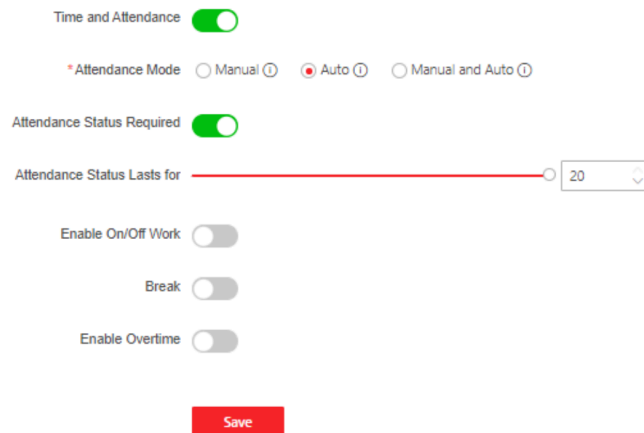

**Figure 8-20 Time and Attendance**

## Disable Attendance Mode via Web

Disable the attendance mode and the system will not display the attendance status on the initial page.

### Steps

1. Click **System and Maintenance** → **System Configuration** → **Platform Attendance** to enter the settings page.
2. Disable the **Time and Attendance**.

### Result

You will not view or configure the attendance status on the initial page. And the system will follow the attendance rule that configured on the platform.

## Set Manual Attendance via Web

Set the attendance mode as manual, and you should select a status manually when you take attendance.

### Before You Start

Add at least one user, and set the user's authentication mode. For details, see *User Management*.

### Steps

1. Click **System and Maintenance** → **System Configuration** → **Platform Attendance** to enter the settings page.
2. Set the **Attendance Mode** as **Manual**.
3. Enable the **Attendance Status Required** and set the attendance status lasts duration.



4. Enable a group of attendance status.

---

 **Note**

The Attendance Property will not be changed.

5. **Optional:** Select an status and change its name if required.

### Result

You should select an attendance status manually after authentication.

---

 **Note**

If you do not select a status, the authentication will be failed and it will not be marked as a valid attendance.

---

## Set Auto Attendance via Web

Set the attendance mode as auto, and you can set the attendance status and its available schedule. The system will automatically change the attendance status according to the configured schedule.

### Before You Start

Add at least one user, and set the user's authentication mode. For details, see *User Management*.

### Steps

1. Click **System and Maintenance** → **System Configuration** → **Platform Attendance** to enter the settings page.
2. Set the **Attendance Mode** as **Auto**.
3. Enable the **Attendance Status Required** function.
4. Enable a group of attendance status.

---

 **Note**

The Attendance Property will not be changed.

5. **Optional:** Select an status and change its name if required.
6. Set the status' schedule. Refers to for details.

## Set Manual and Auto Attendance via Web

Set the attendance mode as **Manual and Auto**, and the system will automatically change the attendance status according to the configured schedule. At the same time you can manually change the attendance status after the authentication.

### Before You Start

Add at least one user, and set the user's authentication mode. For details, see *User Management*.

## Steps

1. Click **System and Maintenance** → **System Configuration** → **Platform Attendance** to enter the settings page.
2. Set the **Attendance Mode** as **Manual and Auto**.
3. Enable the **Attendance Status Required** function.
4. Enable a group of attendance status.



The Attendance Property will not be changed.

5. **Optional:** Select an status and change its name if required.
6. Set the status' schedule. Refers to for details.

## Result

On the initial page and authenticate. The authentication will be marked as the configured attendance status according to the schedule. If you tap the edit icon on the result tab, you can select a status to take attendance manually, the authentication will be marked as the edited attendance status.

## Example

If set the **Break Out** as Monday 11:00, and **Break In** as Monday 12:00, the valid user's authentication from Monday 11:00 to 12:00 will be marked as break.

## 8.10 Preference Settings

### 8.10.1 Set Startup Image via PC Web

Set startup image.

Go to **System and Maintenance** → **Preference** → **Screen Display** .

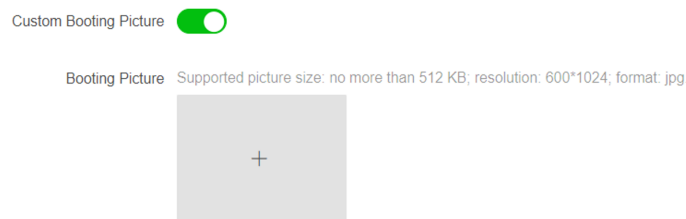

**Figure 8-21 Startup Image**

Enable **Custom Booting Picture**, click + and select a booting picture from local browse.



Supported picture size: no more than 512 KB; resolution: 600\*1024; format: jpg.

---

Click **Save**.

## 8.10.2 Set Standby Image via PC Web

Set the standby image parameters, including the time to enter standby, screen saver picture, displayed effect, and slide show interval.

Go to **System and Maintenance** → **Preference** → **Screen Display** .

Time to Enter Standby  s

Screen Saver Picture  Default  Custom

Displayed Effect  Stretch  Adaptive  Fill

**Figure 8-22 Standby Image Settings**

Set the standby image parameters, and click **Save**.

### Time to Enter Standby

The device will show the standby image after the configured time duration.

### Screen Saver Picture

Set the standby images as default image or customized image. Select **Custom**, and click **+** to upload a standby picture from the local browse.



### Note

No more than 3 picture(s) are allowed. Single picture size: no more than 1024 KB; format: jpg.

---

### Display Effect

Set the standby picture's display effect as **Stretch**, **Adaptive**, or **Fill**.

### Slide Show Interval

If you add multiple pictures, you can set the pictures' switching time.

## 8.10.3 Set Sleep Time via PC Web

The device will in sleep mode after the configured time duration. The function can reduce power consumption.

Go to **System and Maintenance** → **Preference** → **Screen Display** .



**Figure 8-23 Sleep Settings**

Slide **Sleep** and set the sleep time.

Click **Save**.

## 8.10.4 Customize Authentication Desk via PC Web

Customize the modules on the authentication page/desk.

### Steps

1. Go to **System and Maintenance** → **Preference** → **Custom Home Page** .
2. Select **Application Mode**.

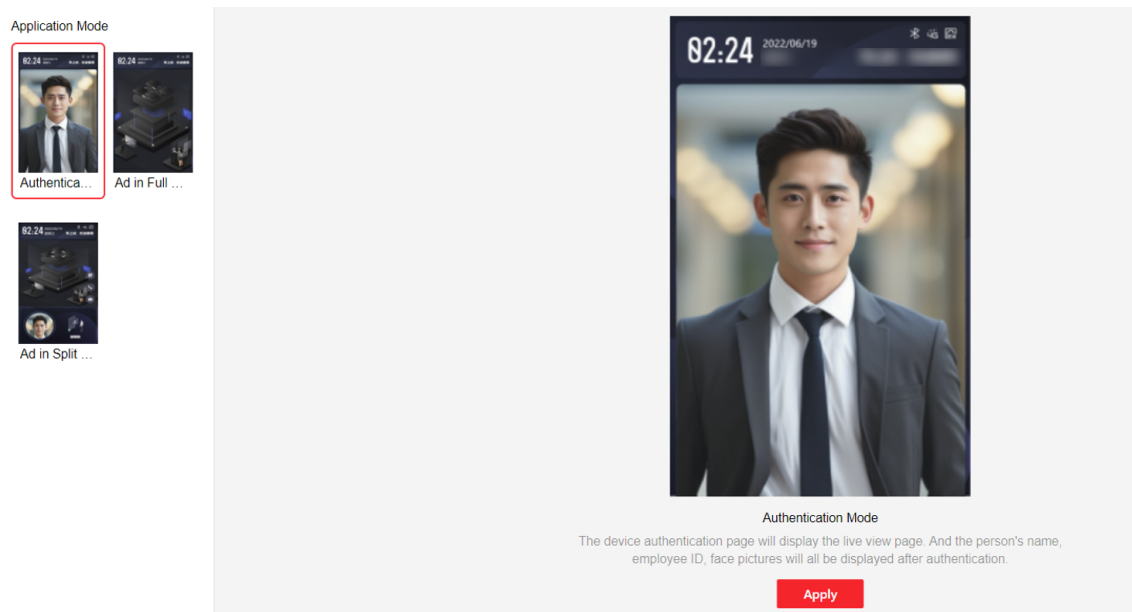

**Figure 8-24 Select Application Mode**

### Authentication Mode

The device authentication page will display the live view page. And the person's name, employee ID, face pictures will all be displayed after authentication.

### Ad in Full Screen

The ad takes up the full screen of authentication page. Screensaver, Welcome Message can be played in ad.

### Ad in Split Screen

Authentication page includes ad area and authentication area. Screensaver, Welcome Message can be played in ad.

3. Click **Apply**.

## 8.10.5 Set Notice Publication via PC Web

You can set the notice publication for the device.

Go to **System and Maintenance** → **Preference** → **Notice Publication** .

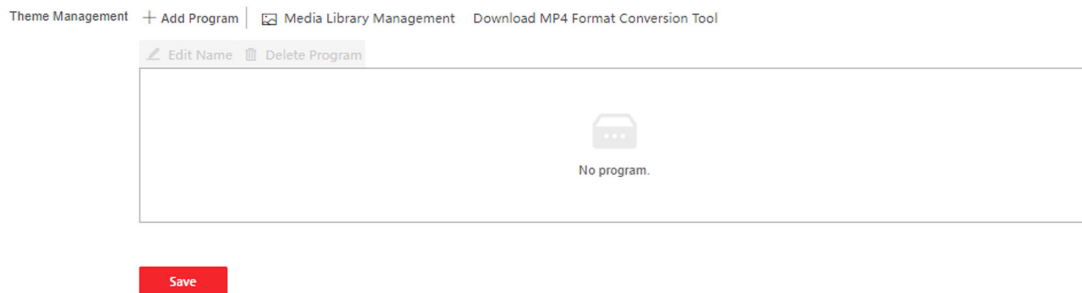

Figure 8-25 Notice Publication

### Download MP4 Format Conversion Tool

You can click **Download MP4 Format Conversion Tool** if you need to change the format.

### Material Management

You can click **+ Add Theme**, and set **Theme Name** and **Theme Type**.

Click **Upload**, and click **+** to upload the picture or video from the local PC.



### Note

By now, there is only one theme can be added.

---

### Add Program

You can set the program name and select program type.

#### Picture

If you select picture, you can click **+** to add picture.

#### Welcome Message

If you select welcome message, you can set the template, content, font size and color of main and sub title. You can also custom the background picture.

## Standard

If you select standard, you can set the background color and picture.

## Play Schedule

After you have created a theme, you can select the theme and draw a schedule on the time line. Select the drawn schedule, and you can edit the exact start and end time.

Select the drawn schedule and you can click **Delete** or **Delete All** to delete the schedule.

## Slide Show Interval

Drag the block or enter the number to set the slide show interval. The picture and video will be changed according to the interval.

## 8.10.6 Set Prompt Schedule via PC Web

Customize the output audio content when authentication succeeded and failed.

### Steps

1. Go to **System and Maintenance** → **Preference** → **Prompt Schedule** .

Enable

Appellation  None

**Time Period When Authentication Succeeded**

Period1 Delete

Time

Language  English

\* Audio Prompt Content

+ Add Time Duration

**Time Period When Authentication Failed**

Period1 Delete

Time

Language  English

\* Audio Prompt Content

+ Add Time Duration

Save

**Figure 8-26 Prompt Schedule**

2. Enable the function.
3. Set the appellation.

4. Select time schedule.
5. Set the time period when authentication succeeded.
  - 1) Click **Add Time Duration**.
  - 2) Set the time duration.

---

 **Note**

If authentication is succeeded in the configured time duration, the device will broadcast the configured content.

- 3) Set the audio prompt content.
  - 4) **Optional:** Repeat substep 1 to 3.
  - 5) **Optional:** Click  to delete the configured time duration.
6. Set the time duration when authentication failed.
    - 1) Click **Add Time Duration**.
    - 2) Set the time duration.

---

 **Note**

If authentication is failed in the configured time duration, the device will broadcast the configured content.







- 3) Set the audio content.
  - 4) **Optional:** Repeat substep 1 to 3.
  - 5) **Optional:** Click  to delete the configured time duration.
7. Click **Save** to save the settings.

## 8.10.7 Customize Prompt Voice via PC Web

You can customize prompt voices for the device.

### Steps

1. Go to **System and Maintenance** → **Preference** → **Custom Prompt** .

Custom Type	Importing Status	Operation
Call Center	Not Imported	
Nobody Answered	Not Imported	
Thanks	Not Imported	
Authenticating Failed	Not Imported	
The Door Is Open	Not Imported	
Please Wear the Safety Helmet	Not Imported	
Please Wear the Mask	Not Imported	

**Figure 8-27 Custom Prompt**

2. Click  →  and import audio file from local PC according to your actual needs.

---

 **Note**

The uploaded audio file should be less than 512 kb, in WAV format.

---

### 8.10.8 Set Authentication Result Text via PC Web

#### Steps

1. Go to **System and Maintenance** → **Preference** → **Authentication Result Text** .

Customize Authentication Resu...

Text	Content	Custom
	* Stranger	<input type="text"/>
	* Authenticated	<input type="text"/>
	* Authenticating Failed	<input type="text"/>

Figure 8-28 Authentication Result Text

2. Enable **Customize Authentication Result Text**.
3. Enter custom texts.
4. Click **Save**.

## 8.11 System and Maintenance

### 8.11.1 Reboot

You can reboot the device.

Click **System and Maintenance** → **Maintenance** → **Restart** to enter the settings page.

Click **Restart** to reboot the device.

### 8.11.2 Upgrade

#### Upgrade Locally via PC Web

You can upgrade the device locally.

Click **System and Maintenance** → **Maintenance** → **Upgrade** to enter the settings page.

Select an upgrade type from the drop-down list. Click  and select the upgrade file from your local PC. Click **Upgrade** to start upgrading.



### Online Upgrading via PC Web

You can upgrade the device online.

Click **System and Maintenance** → **Maintenance** → **Upgrade** to enter the settings page.

Click **Check for Update** to check whether there is updated versions.

If the device is connected to the network and added to Hik-Connect App, you can tap **Device Upgrade** → **Online Upgrade** on device for upgrading when there is an updated version in Hik-Connect App.

### 8.11.3 Restoration

#### Restore to Factory Settings via Web Browser

You can restore device to factory settings.

Click **System and Maintenance** → **Maintenance** → **Backup and Reset** to enter the settings page.

Click **Restore All**, all parameters will be restored to the factory settings. You should activate the device before usage.

#### Restore to Default Settings via PC Web

You can restore device to default settings.

Click **System and Maintenance** → **Maintenance** → **Backup and Reset** to enter the settings page.

Click **Restore**, the device will restore to the default settings, except for the device IP address and the user information.

### 8.11.4 Export Device Parameters via PC Web

Export device parameters.

Go to **System and Maintenance** → **Maintenance** → **Backup and Reset** .

#### Backup

Click **Export** to export device parameters.



#### Note

Export device parameters and import those parameters to other devices.

---

### 8.11.5 Import Device Parameters via PC Web

Import the configuration parameters.

Go to **System and Maintenance** → **Maintenance** → **Backup and Reset** .

#### Import Config File

Click  and select a file from local PC. Click **Import**.

### 8.11.6 Device Debugging

You can set device debugging parameters.

#### Enable/Disable SSH via Web Browser

You can enable SSH to perform remote debugging.

Click **System and Maintenance** → **Maintenance** → **Device Debugging** → **Log for Debugging**.

#### Enable SSH

SSH is used for remote debugging. When you don't need to use this service, it's recommended to disable SSH to improve security.

#### Print Device Log via PC Web

You can print out the device log.

Click **System and Maintenance** → **Maintenance** → **Log** to enter the settings page.

Click **Export** to print out the device log.

#### Capture Network Packet via PC Web

Set the capture packet duration and size and start capture. You can view the log and debug according to the capture result.

Go to **System and Maintenance** → **Maintenance** → **Device Debugging** → **Log for Debugging** .

Set **Capture Packet Duration**, **Capture Packet Size**, and click **Start Capture**.

#### Test Protocol via PC Web

Select a protocol address, and enter the protocol to test. You can debug the device according to the response header and returned value.

Go to **System and Maintenance** → **Maintenance** → **Device Debugging** → **Protocol Testing** .

\*Enter Protocol Address GET Enter,/ISAPI/...

Execute

**Testing Result**

Response Header

Return Value

**Figure 8-29 Protocol Testing**

Select a protocol address, and enter the protocol. Click **Execute**.

Debug the device according to the response header and returned value.

## Network Diagnosis via PC Web

Enter the device IP address or domain name, you can perform PING settings. Debug the network according to the PING result.

Go to **System and Maintenance** → **Maintenance** → **Device Debugging** → **Network Diagnosis** .

\*IP/Domain

Network Connection Mode  Wired Network  Self-Adaptive

Ping Duration  s

\* Ping Data Package Size  Bytes

**Diagnose**

Ping Result

**Figure 8-30 Network Diagnosis**

Enter the device IP for PING operation, select the network connection mode, PING duration, and Ping data package size (default parameter is recommended.) Click **Diagnose**. The result will displayed in **PING Result**.

## Set Network Penetration Service via PC Web

When the devcie is deployed in the LAN, you can enable the penetration service to realize device remote management.

### Steps

1. Go to **System and Maintenance** → **Maintenance** → **Device Debugging** → **Network Penetration Service**.
2. Slide **Enable Penetration Service**.
3. Set **Server IP Address** and **Server Port**. Create **User Name** and **Password**.
4. **Optional**: You can set **Heartbeat Timeout**. The value range is 1 to 6000.
5. **Optional**: You can view the status of the penetration service. Click **Refresh** to refresh the status.
6. Click **Save**.

---

### **Note**

The penetration service will auto disabled after 48 h.

---

### 8.11.7 View Log via PC Web

You can search and view the device logs.

Go to **System and Maintenance** → **Maintenance** → **Log** .

Set the major and minor type of the log type. Set the start time and end time for searching, and click **Search**.

The results will be displayed below, which including the No., time, the major type the minor type, the channel No., the local/remote user information, the remote host IP, etc.

### 8.11.8 Advanced Settings via PC Web

You can configure face parameters, palm parameters, and view version information.

Go to **System and Maintenance** → **Maintenance** → **Advanced Settings** .

Enter the device activation password and click **Enter**.

#### Face Parameter

Enable **Custom Anti-Spoofing Detection** and you can set the **Anti-Spoofing Detection Threshold 1:1, Anti-Spoofing Detection Threshold 1:N**.

Enable **Lock Face for Authentication**, and set **Lock Duration**. The face will be locked for the set lock duration after the failed attempt limit of anti-spoofing detection has been reached.

Click **Save**.

#### Palm Print Parameter

Enable **Custom Anti-Spoofing Detection** and you can set the **Anti-Spoofing Detection Threshold**.

Click **Save**.

#### Version Information

You can view the different version information here.

### 8.11.9 Security Management

Set security level when login the PC web.

Go to **System and Maintenance** → **Safe** → **Security Service** .

#### Security Mode

High security level when logging in and verify user information.

#### Compatible Mode

Compatible with old user verification method.

Click **Save**.

## 8.11.10 Certificate Management

It helps to manage the server/client certificates and CA certificate.



The function is only supported by certain device models.

---

### Create and Import Self-signed Certificate

#### Steps

1. Go to **System and Maintenance** → **Safe** → **Certificate Management** .
2. In the **Certificate Files** area, select a **Certificate Type** from the drop-down list.
3. Click **Create**.
4. Input certificate information.
5. Click **OK** to save and install the certificate.

The created certificate is displayed in the **Certificate Details** area.

The certificate will be saved automatically.

6. Download the certificate and save it to an asking file in the local computer.
7. Send the asking file to a certification authority for signature.
8. Import the signed certificate.
  - 1) Select a certificate type in the **Import Key** area, and select a certificate from the local, and click **Import**.
  - 2) Select a certificate type in the **Import Communication Certificate** area, and select a certificate from the local, and click **Import**.

### Import Other Authorized Certificate

If you already has an authorized certificate (not created by the device), you can import it to the device directly.

#### Steps

1. Go to **System and Maintenance** → **Safe** → **Certificate Management** .
2. In the **Import Key** and **Import Communication Certificate** areas, select certificate type and upload certificate.
3. Click **Import**.

### Import CA Certificate

#### Before You Start

Prepare a CA certificate in advance.

### Steps

1. Go to **System and Maintenance** → **Safe** → **Certificate Management** .
  2. Create an ID in the **Import CA Certificate** area.
- 



### Note

The input certificate ID cannot be the same as the existing ones.

---

3. Upload a certificate file from the local.
4. Click **Import**.

## Chapter 9 Other Platforms to Configure

You can also configure the device via iVMS-4200 Client Software or HikCentral Access Control. For details, see the platforms' user manual.

### **iVMS-4200 Client Software**

Click/tap the link to view the client software's user manual.

<http://enpinfodata.hikvision.com/analysisQR/showQR/ca930247>

### **HikCentral Access Control (HCAC)**

Click/tap the link to view the HCAC's user manual.

<http://enpinfodata.hikvision.com/analysisQR/showQR/f2f6cf42>



## Appendix A. Tips for Scanning Fingerprint

### Recommended Finger

Forefinger, middle finger or the third finger.

### Correct Scanning

The figure displayed below is the correct way to scan your finger:

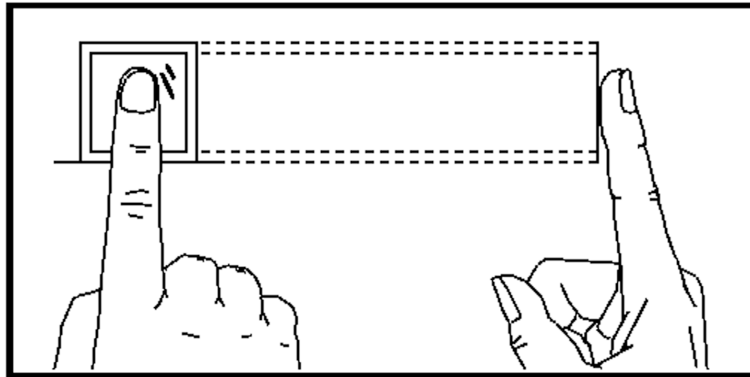

You should press your finger on the scanner horizontally. The center of your scanned finger should align with the scanner center.

### Incorrect Scanning

The figures of scanning fingerprint displayed below are incorrect:

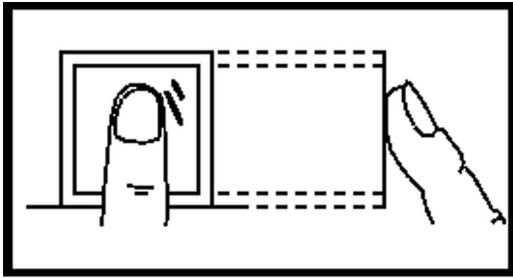

Vertical

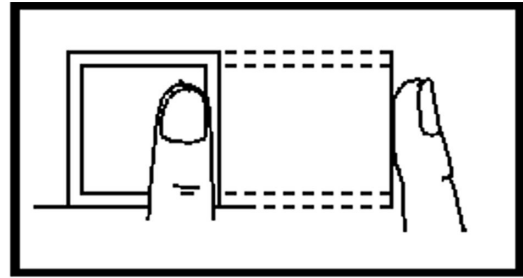

Edge I

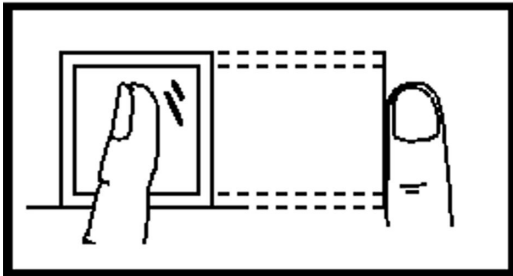

Side

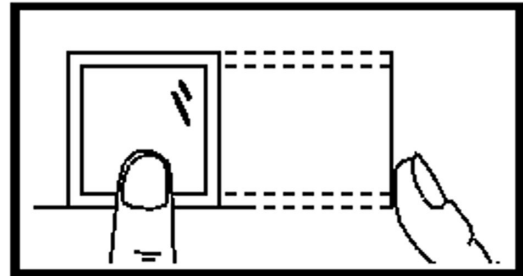

Edge II

### Environment

The scanner should avoid direct sun light, high temperature, humid conditions and rain. When it is dry, the scanner may not recognize your fingerprint successfully. You can blow your finger and scan again.

### Others

If your fingerprint is shallow, or it is hard to scan your fingerprint, we recommend you to use other authentication methods.

If you have injuries on the scanned finger, the scanner may not recognize. You can change another finger and try again.

## Appendix B. Tips When Collecting/Comparing Face Picture

The position when collecting or comparing face picture is as below:

### Positions (Recommended Distance: 0.3 m)

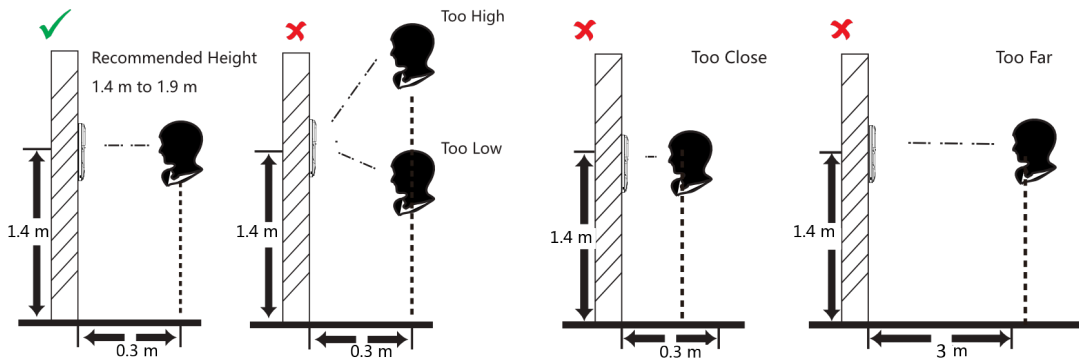

### Expression

- Keep your expression naturally when collecting or comparing face pictures, just like the expression in the picture below.



- Do not wear hat, sunglasses, or other accessories that can affect the facial recognition function.
- Do not make your hair cover your eyes, ears, etc. and heavy makeup is not allowed.

### Posture

In order to get a good quality and accurate face picture, position your face looking at the camera when collecting or comparing face pictures.



## Size

Make sure your face is in the middle of the collecting window.

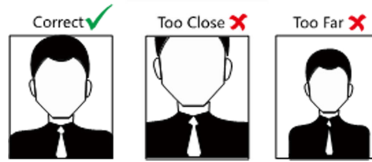

## **Appendix C. Tips for Adding Palm Print and Palm Vein**

- When recognizing the palm print and palm vein, place the center of the palm at a distance of 5~12 cm from the center of the device, and pay attention to keeping it parallel to the peripheral module.
- When the peripheral module access to the new face recognition terminal, the data of the peripheral module needs to be cleared and re-issued or collected.
- The palms of the hands need to be kept clean to avoid dirt.
- The surface of the peripheral module should be kept clean to avoid false alarms caused by the sensor.

## Appendix D. Tips for Installation Environment

### 1. Light Source Illumination Reference Value



Candle: 10Lux



Bulb: 100~850Lux



Sunlight: More than 1200Lux

### 2. Avoid backlight, direct and indirect sunlight

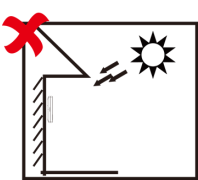

Backlight

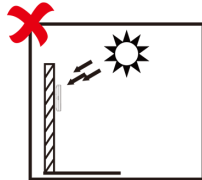

Direct Sunlight

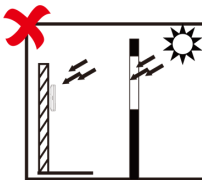

Direct Sunlight  
through Window

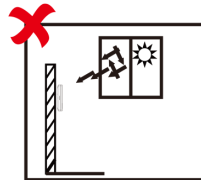

Indirect Light  
through Window

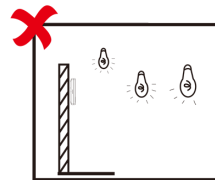

Close to Light

## Appendix E. Dimension

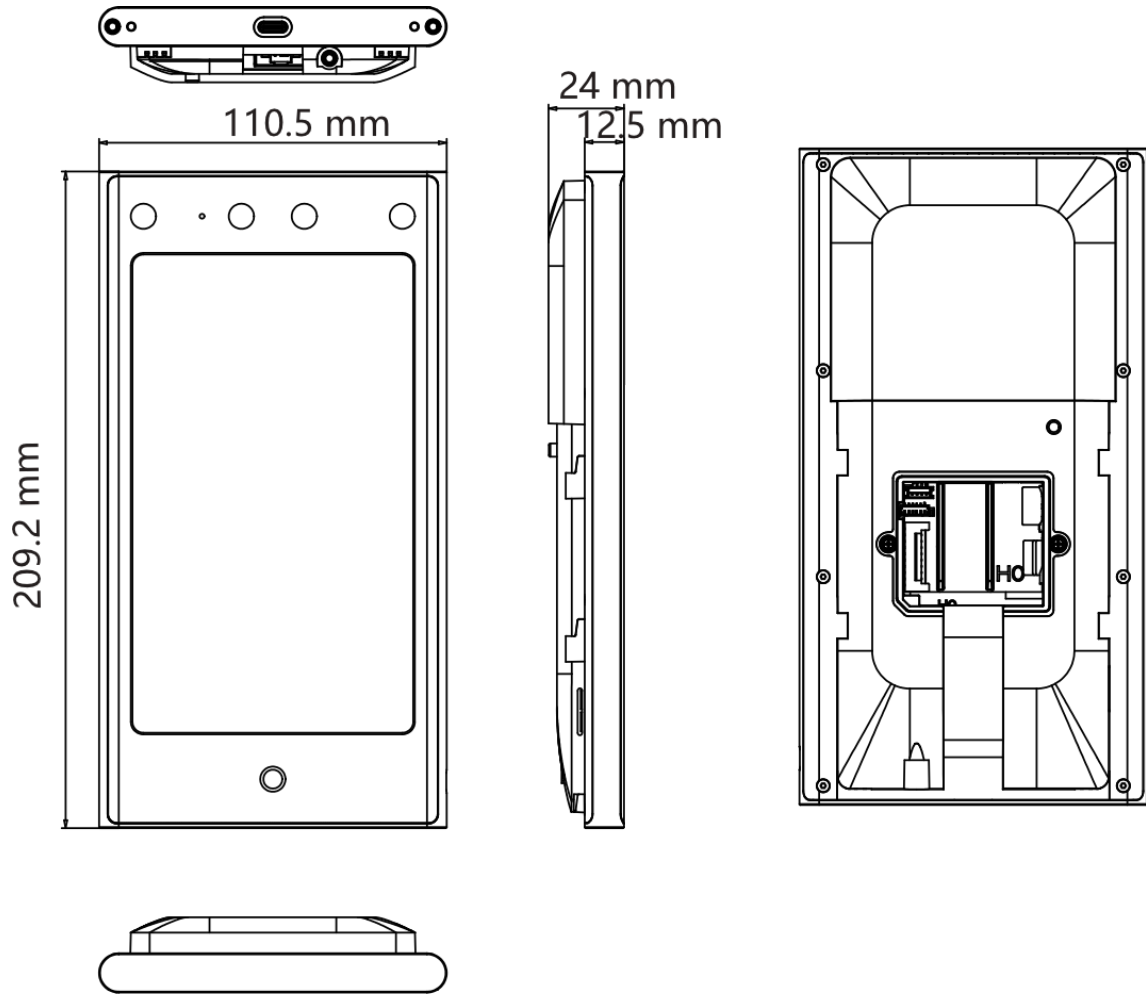
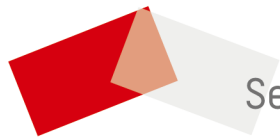

Figure E-1 Dimension



See Far, Go Further