

ENERGIZER MAX

9V

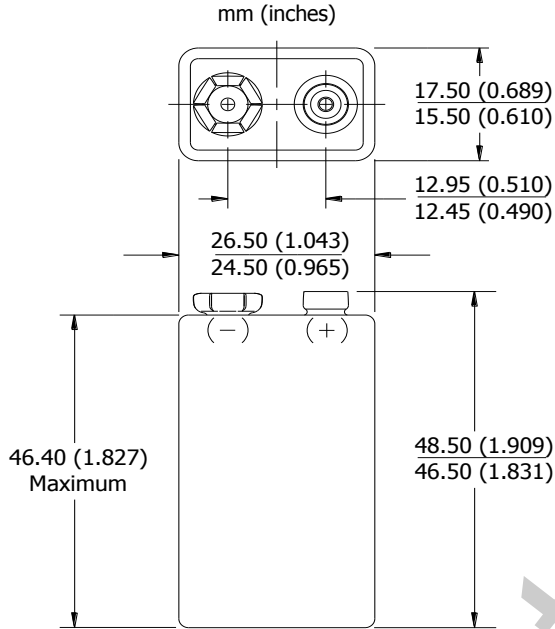

Industry Standard Dimensions



Specifications

Classification:	Alkaline
Chemical System:	Zinc-Manganese Dioxide (Zn/MnO ₂) No added mercury or cadmium
Designation:	ANSI-1604A, IEC-6LR61
Nominal Voltage:	9.0 volts
Operating Temp:	-18°C to 55°C (0°F to 130°F)
Typical Weight:	45.6 grams (1.6 oz.)
Typical Volume:	21.1 cubic centimeters (1.3 cubic inch)
Jacket:	Metal
Shelf Life:	5 years at 21°C
Terminal:	Miniature Snap

Milliamp-Hours Capacity

Continuous discharge to 4.8 volts at 21°C

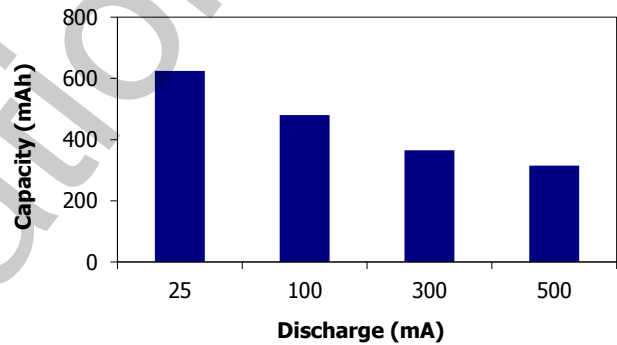

Device Selection Guide:

- Toy
- Baby Monitor
- Garage Opener
- Clock Radio
- Smoke Detector

Battery Selection Indicator

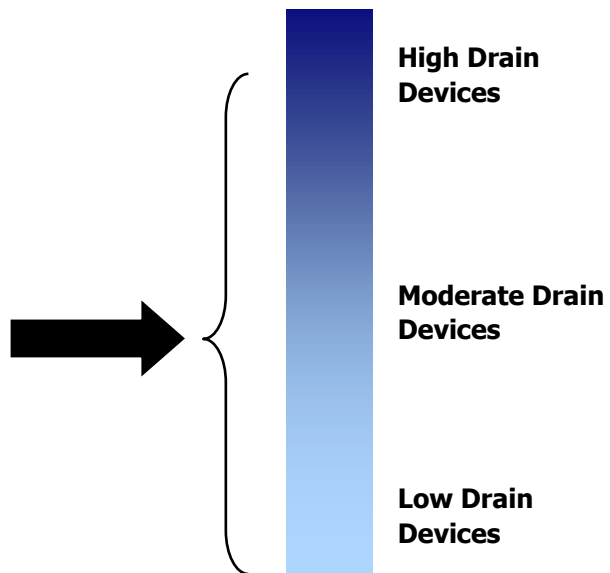

Important Notice

This datasheet contains typical information specific to products manufactured at the time of its publication.
©Energizer Holdings, Inc. - Contents herein do not constitute a warranty.

ENERGIZER 522

9V

Constant Resistance Performance Typical Characteristics (21°C)

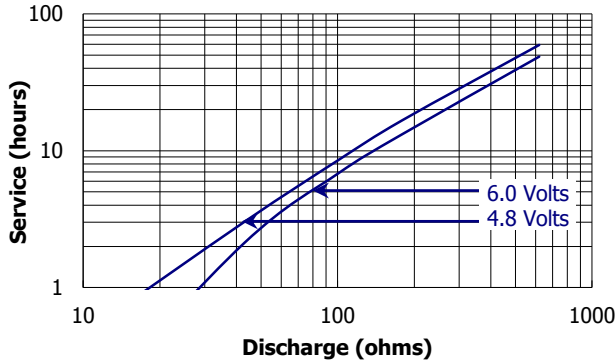

Constant Current Performance Typical Characteristics (21°C)

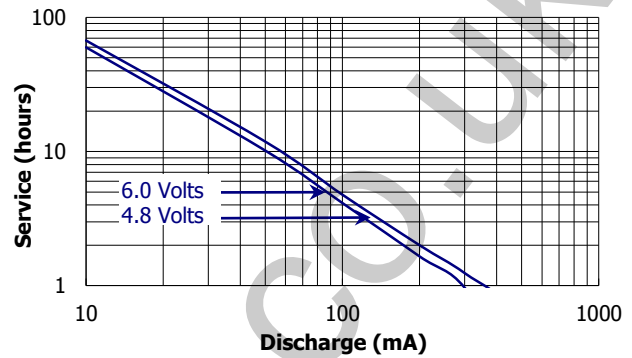

Industry Standard Tests (21°C)

RADIO 620 ohm 2 hrs/day

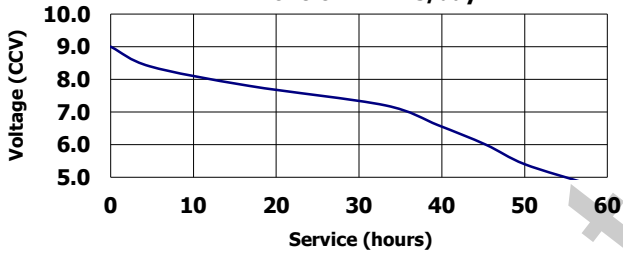

TOY 270 ohm 1 hr/day

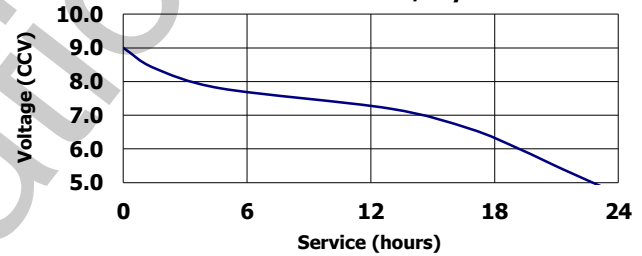

ACCELERATED SMOKE DETECTOR 10K/620 ohm 1 sec/hr pulse

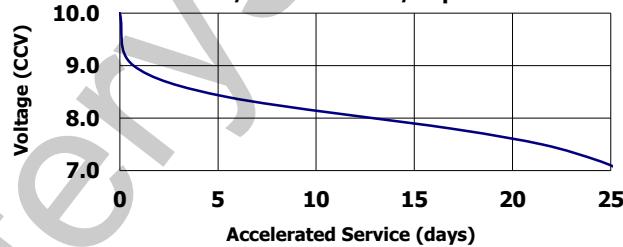

Important Notice

This datasheet contains typical information specific to products manufactured at the time of its publication.
©Energizer Holdings, Inc. - Contents herein do not constitute a warranty.